

ABS Coolant Proof Caliper Coolant Proof Micrometer

Bulletin No. 1813-293/500

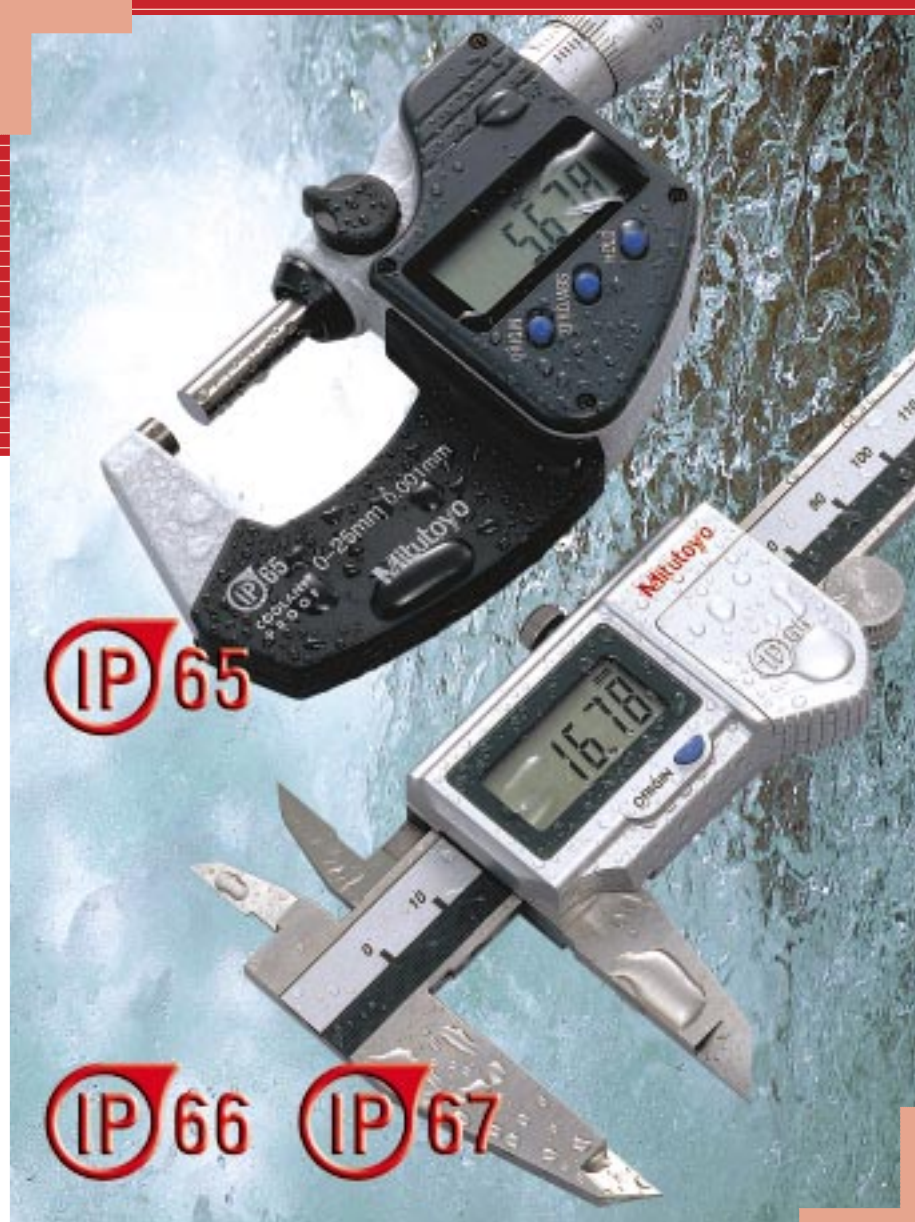

Coolant Proof withstands water, oil, and dirt.

Development of new coolant resistant technology has led to the creation of **IP66/IP67** protection level calipers.

New waterproofing technology has enabled the creation of **IP65** protection level micrometers.

Mitutoyo

IP66
IP67

ABS Coolant Proof Caliper/

Achieving IP66/IP67 protection level

ABS Coolant Proof Caliper



Type	Level	Description
Protection from solid objects (people or things)	6: Dust-tight	No ingress of dust.
Protection from liquids (water, etc.)	6: Protected against powerful water jets.	Water projected in powerful jets* against the enclosure from any direction shall have no harmful effects.
	7: Protected against the effects of temporary immersion in water.	Ingress of water in quantities causing harmful effects shall not be possible when the enclosure is temporarily immersed 1 meter in water under standardized conditions of pressure and time.



* Size of direct jets: uses 12.5 mm (inner diameter) nozzle emitting a 100 kPa jet of water at 100 liters per minute for at least 3 minutes from a distance of approx. 3 meters.

Achieving IP65 protection level

Coolant Proof Micrometer



Type	Level	Description
Protection from solid objects (people or things)	6: Dust-tight	Protection against ingress of dust and full protection against contact.
Protection from liquids (water, etc.)	5: Protected against water jets.	Water projected in jets* against the enclosure from any direction shall have no harmful effects.



* Size of direct jets: uses 6.3 mm (inner diameter) nozzle emitting a 30 kPa jet of water at 12.5 liters per minute for at least 3 minutes from a distance of approx. 3 meters.

Air leakage detection system used for water-proof testing

Generally, air leakage tests are performed to evaluate water resistance.

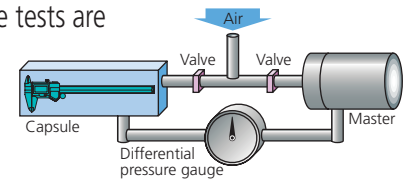

Testing begins by

placing a measuring tool into a capsule. Next, air with equivalent pressure is supplied to the capsule and the master, then the valves are closed. If none of the air in the capsule seeps into the measuring tool, the capsule's air pressure will remain equal to that in the master, and the differential pressure gauge will continue to point to the center. However, if some air does seep into the measuring tool, it will create an air pressure difference indicated by the differential pressure gauge. Thus, detection of air pressure differences is used as a criterion for judging leakage. Every single unit of the ABS Coolant Proof calipers and Coolant Proof micrometer is tested this way for air leakage to help ensure product quality.

water, oil, and dirt.

P65 Coolant Proof Micrometer



Can be used with all of these coolants: (FYI)

* Tests were performed with positive results for all of the following types of coolants in brands

Water-insoluble cutting oil	Water-soluble cutting oil	EDM electrolytes
· Activated chlorine sulfur	· Emulsions	· Brake fluid
· Inert chlorine sulfur	· Soluble oils	· Cleaning agents
· Activated sulfur	· Solutions	· Water-soluble cleaning agents
· Inert sulfur		· Anti-corrosive oil



ABS Coolant Proof callipers being tested by air leakage test equipment



Temperature environment test

This equipment is used to conduct reliability tests under various extreme temperatures and humidity levels.



Work environment test

This equipment is used to perform long-term continuous spindle operation tests.



Coolant Proof micrometer being tested by air leakage test equipment



Electronic component test

A fully automated inspection system is used to ensure the reliability of all pre-shipment inspections of electronic components that have narrow precision tolerances, switching functions, etc.

Digital calipers with waterproof absolute scale: ABS Coolant Proof Caliper

•Patented •Patent pending •Registered design

Ideal for use in environments with heavy exposure to coolants.



500-752

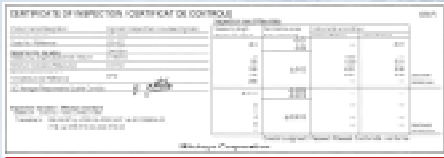

Certificate of inspection



500-623

500-634

500-622

- The IP66/IP67 Coolant Proof Caliper incorporates a new length measuring system that provides protection level IP66/IP67 so the calipers can be used even in environments where large amounts of cutting oils are being sprayed from various directions (only vernier calipers could be used before).
- No need to wipe off water and oil from the main scale during use.
- Built-in ABS (absolute) scale means that these calipers are ready to use immediately after power-on without origin resetting.

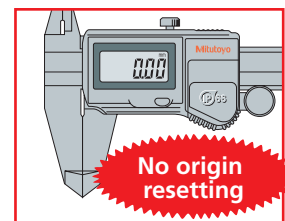
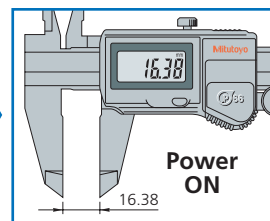
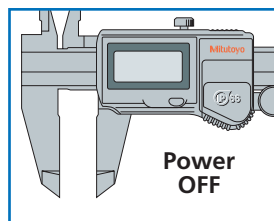

- Auto power ON/OFF function.
- Measurement data output function is available with a water-resistant connection cable.
- Certificate of inspection* is included.

*It is not the type used to obtain calibration certificates.

Order No. (IP66)

Order No.	Range	Order No.	Range
500-632	150mm	500-682	6"/150mm
500-637	150mm	—	—
500-633	200mm	500-683	8"/200mm
500-638	200mm	—	—
500-634	300mm	500-684	12"/300mm
500-639	300mm	—	—
500-622	150mm	500-672	6"/150mm
500-626	150mm	—	—
500-623	200mm	500-673	8"/200mm
500-627	200mm	—	—
500-624	300mm	500-674	12"/300mm
500-628	300mm	—	—

Order No. (IP67)

Order No.	Range	Order No.	Range	Remarks
500-712	150mm	500-762	6"/150mm	with data output, with thumb roller
500-716	150mm	—	—	with data output, without thumb roller
500-713	200mm	500-763	8"/200mm	with data output, with thumb roller
500-717	200mm	—	—	with data output, without thumb roller
—	—	—	—	with data output, with thumb roller
—	—	—	—	with data output, without thumb roller
500-702	150mm	500-752	6"/150mm	without data output, with thumb roller
500-706	150mm	—	—	without data output, without thumb roller
500-703	200mm	500-753	8"/200mm	without data output, with thumb roller
500-707	200mm	—	—	without data output, without thumb roller
—	—	—	—	without data output, with thumb roller
—	—	—	—	without data output, without thumb roller

Specifications

Resolution	.0005"/0.01mm, 0.01mm
Accuracy*1	±.001"/±0.02mm (≤8"/200mm), ±.0015"/±0.03mm (>8"/200mm)
Functions	Origin setting, Auto power ON/OFF*2, Measurement data output, Error reporting
Protection level	IP66 or IP67 (IEC60529), Anti-corrosion treatment is required after use
Power supply	One button-type silver oxide battery (SR44) (two batteries for 12"/300mm models)
Battery life	Three years under normal use conditions (one year for 12"/300mm models)
Length standard*3 encoder	Electromagnetic induction absolute linear encoder
Maximum response speed	Unlimited
Mass	168g (150mm), 198g (200mm), 350g (300mm)
Standard accessories	Button-type silver oxide battery (SR44, No. 938882), and one screwdriver for battery replacement

*1 Quantizing error ±1 count is not included.

*2 Display automatically shuts off approximately 20 minutes after completing measurements.
Power is automatically turned on when slider is moved.

*3 Patented (in Japan and U.S.A.), patents pending (in China, Germany, United Kingdom, France,
Switzerland, and India)

Dimensions

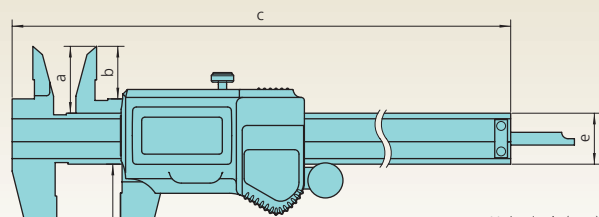

Unit: inch (mm)					
Range	a	b	c	d	e
6"/150mm	.83" (21)	.66" (16.5)	9.18" (231)	1.59" (40)	.64" (16)
8"/200mm	.97" (24.5)	.79" (20)	11.45" (288)	1.99" (50)	.64" (16)
12"/300mm	1.11" (28)	.87" (21.8)	16.21" (408)	2.54" (64)	.79" (20)

Optional accessories

• Water-resistance connection cable*4

1-meter cable: **No. 05CZA624**

2-meter cable: **No. 05CZA625**

Output switch



*4 This connection cable is dedicated
for Coolant Proof Caliper.

• DP-1VR Digimatic Mini-Processor

No. 264-504-5A

(Data processing device
for quality control applications)

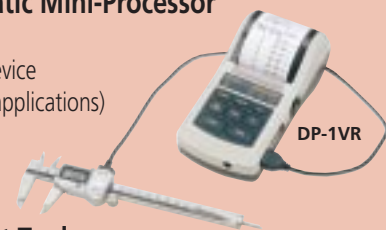

• Keyboard Input Tool

No. 264-005

• RS232C Input Tool

No. 264-007

• USB Input Tool

(Measurement data input device
with USB keyboard signals)

No. 262-012



Digital Micrometer with Coolant-proof Function

Coolant Proof Micrometer

•Patent pending •Design registration pending

New technology Digimatic micrometers for use in coolant-exposed environments.



- Based on new water-proof structural technology, these micrometers provide IP65 protection levels, enabling use in environments exposed to cutting oil, etc.
- Measurement data output function is available with a water-resistant connection cable.
- Oil-resistance materials are used in all plastic components.
- $\pm 0.0005''/\pm 1 \mu\text{m}$ instrumental error (3"/75 mm or less range models)
- Auto power ON/OFF function.
- Certificate of inspection* is included. (2"/50mm or less range models)

*It is not the type used to obtain calibration certificates.



Certificate of inspection



Order No. (with ratchet stop)

Order No.	Range	Order No.	Range
293-230	0-25mm	293-330	0-1"/0-25.4mm
293-231	25-50mm	293-331	1-2"/25.4-50.8mm
293-232	50-75mm	293-332	2-3"/50.8-76.2mm
293-233	75-100mm	293-333	3-4"/76.2-101.6mm
293-240*	0-25mm	293-340*	0-1"/0-25.4mm
293-241*	25-50mm	293-341*	1-2"/25.4-50.8mm
293-242*	50-75mm	293-342*	2-3"/50.8-76.2mm
293-243*	75-100mm	293-343*	3-4"/76.2-101.6mm

*without data output function

Order No. (with ratchet thimble)

Order No.	Range	Order No.	Range
293-234	0-25mm	293-334	0-1"/0-25.4mm
293-235	25-50mm	—	—
293-236	50-75mm	—	—
293-237	75-100mm	—	—
293-244*	0-25mm	293-344*	0-1"/0-25.4mm
293-245*	25-50mm	293-345*	1-2"/25.4-50.8mm
293-246*	50-75mm	293-346*	2-3"/50.8-76.2mm
293-247*	75-100mm	293-347*	3-4"/76.2-101.6mm

*without data output function

Order No. (with friction thimble)

Order No.	Range	Order No.	Range
293-238	0-25mm	293-335	0-1"/0-25.4mm
—	—	293-336	1-2"/25.4-50.8mm
293-248*	0-25mm	293-348*	0-1"/0-25.4mm

*without data output function

Dimensions

• With ratchet stop

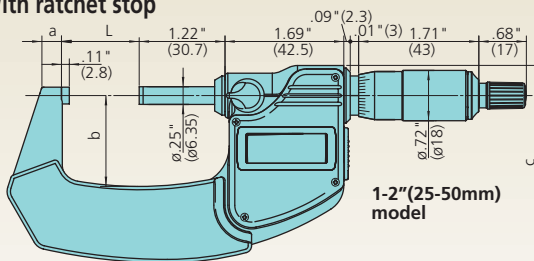

Unit: inch (mm)

Range	L	a	b	c
Ratchet stop				
0-1" (0-25mm)	0 (0)	.36" (9)	.99" (25)	2.38" (59.8)
1-2" (25-50mm)	.99" (25)	.39" (9.8)	1.27" (32)	2.79" (70.3)
2-3" (50-75mm)	1.99" (50)	.50" (12.6)	1.87" (47)	3.65" (91.9)
3-4" (75-100mm)	2.98" (75)	.57" (14)	2.38" (60)	4.49" (112.9)

• With ratchet thimble

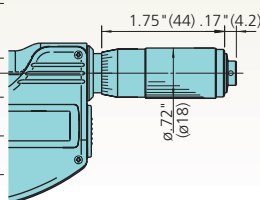

Ratchet thimble				
0-1" (0-25mm)	0 (0)	.36" (9)	.99" (25)	2.38" (59.8)
1-2" (25-50mm)	.99" (25)	.39" (9.8)	1.27" (32)	2.79" (70.3)

Specifications

Resolution	.00005"/0.001mm, 0.001mm
Accuracy*1	±.00005"/±1μm, ±.0001"/±2μm (3-4"/75-100mm)
Functions	Origin setting (for ABS length measurements), Zero-setting (for INC measurements), Data hold, Auto power ON/OFF, Measurement data output, Error reporting
Protection level	IP65 (IEC60529), *Anti-corrosion treatment is required after use.
Flatness	.000012"/0.3μm or less
Parallelism	.00005"/1μm or less (0-1"/0-25mm, 1-2"/25-50mm models) .00008"/2μm or less (2-3"/50-75mm, 3-4"/75-100mm models)
Power supply	One button-type silver oxide battery (SR44)
Battery life	About 1.2 years under normal use conditions
Standard accessories	One standard bar (none for 0-1"/0-25mm models), one button-type silver oxide battery (SR44 No. 938882), one wrench

*Quantizing error ±1 count is not included.

Optional accessories

• Water-resistance connection cable*2

1-meter cable: **No. 05CZA662**

2-meter cable: **No. 05CZA663**



*2 This connection cable is dedicated for Coolant Proof Micrometer.

• DP-1VR Digimatic Mini-Processor

No. 264-504-5A

(Data processing device for quality control applications)



• Keyboard Input Tool

No. 264-005

• RS232C Input Tool

No. 264-007

• USB Input Tool

(Measurement data input device with USB keyboard signals)

No. 264-012





Note:

All our product details, in particular the illustrations, drawings, dimension and performance details and other technical specifications contained in this publication are to be considered to be approximate average values. To this extent, we reserve the right to make changes in design, technical data, dimensions and weight. Our specified standards, similar technical rules and technical specifications, descriptions and illustrations of the products are correct at the time of printing. The current version of our general terms and conditions also apply. Only offers which we have submitted can be considered to be definitive.

- Coordinate Measuring Machines
- Vision Measuring Systems
- Surface, Form and Contour Measurement
- Optical Measuring
- Sensor Systems
- Hardness Measuring
- Digital Scale and DRO Systems
- Small Tool Instruments and Data Management

Mitutoyo America Corporation

www.mitutoyo.com

M³ Solution Center

Michigan
(734) 459-2810

Massachusetts
(978) 692-8765

Illinois
(630) 978-5385

Indiana
(317) 577-6070

California
(626) 961-9661

No. Carolina
(704) 875-8332

Mitutoyo

Precision is our Profession