

### Vision Measuring Systems



### INDEX

#### Vision Measuring Systems

Quick Scope Series 359 — Manual Vision Measuring System	M-2
Quick Image Series 361 — Non-contact 2D Vision Measuring System	M-3
QV Active Compact CNC Vision Measuring Systems	M-4
QV Apex Series 363 — CNC Vision Measuring System	M-5
QV Stream Plus Series 363 — CNC Vision Measuring System	M-6
QV Hyper Series 363 — High-Accuracy CNC Vision Measuring System	M-7
QV Hybrid Type 1, Type 4 Series 365 — CNC Vision Measuring System with a Non-contact Displacement Sensor	M-8
QV- WLI Series 363 — CNC Video Measuring System with White Light Interferometry	M-9
ULTRA QV Series 363 — Ultra-High Accuracy CNC Vision Measuring System	M-10
UMAP Vision System TYPE2 Series 364 — Micro-Form Measuring System	M-11
QV ACCEL Series 363 — Large-Format CNC Vision Measuring System	M-12
Quick Vision with Touch-Trigger Probe	M-13
Accessories for Quick Vision	M-14
OPTI-FIX Kits — Modular Clamping System for Vision Measuring Systems	M-15-17
Quick Guide to Precision Measuring Instruments	M-18,19



QV Active 202

# Quick Scope

## SERIES 359 — Manual Vision Measuring System

### FEATURES

- Surface, contour and fiber-optic ring light illumination options enable users to configure the QS lighting to meet a variety of measurement needs.
- Powerful, Windows®-based QSPAK software offers a spectrum of measuring and analysis capabilities.
- Functions include auto-focus, measurement playback, one-click edge detection, graphic display, 48 different macros and a pattern matching function for several common part features.
- Excellent surface observation model for a variety of workpieces.
- 0.1µm resolution and 150mm Z-axis range.
- Power zoom enables quick magnification changes.
- Fine illumination capability enables lighting changes to match workpiece requirements.

- The quick release system on the stage enables instant switching between coarse and fine movements.
- Quick Navigation function enables the user to repeat measurements quickly.



### ■ Illumination

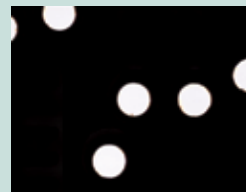

Contour (stage) illumination

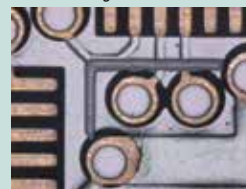

Surface (coaxial) illumination

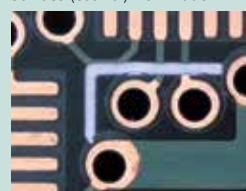

Fiber-optic ring illumination

During automatic measurement the part program provides automatic control over the illumination system, thus providing the necessary balance between user-friendliness and high efficiency.

### SPECIFICATIONS

Model No.	QS-L2010ZB	QS-L3017ZB	QS-L4020ZB
Range (X-axis / Y-axis / Z-axis)	8" x 4" x 6" / 200 x 100 x 150mm	12" x 6.7" x 6" / 300 x 170 x 150mm	15.7" x 8" x 6" / 400 x 200 x 150mm
Resolution	0.1µm		
Scale type	Linear encoder		
Measuring accuracy (at 20°C and 3.0x magnification)	XY: (2.5+20L/1000)µm Z: (5+40L/1000)µm		
Image detecting unit	1/2" 3 MP Color CMOS camera		
Illumination (Halogen)	Co-axial light, fiber-optic ring light, stage light		
Stage glass size	9.84 x 5.91" (250 x 150 mm)	14.57 x 9.45" (370 x 240 mm)	17.32 x 9.45" (440 x 240 mm)
Max. workpiece height	6" / 150mm		
Max. stage loading	22 lbs / 10 kg	44 lbs / 20 kg	33 lbs / 15 kg
Dimensions (W x D x H)	25" x 30" x 28" / 624 x 769 x 722 mm	27" x 33" x 36" / 682 x 837 x 916 mm	30" x 33" x 37" / 757 x 837 x 930 mm
Mass (main unit)	158.7 lbs / 72 kg	308.6 lbs / 140 kg	321.9 lbs / 146 kg

### ■ System diagram

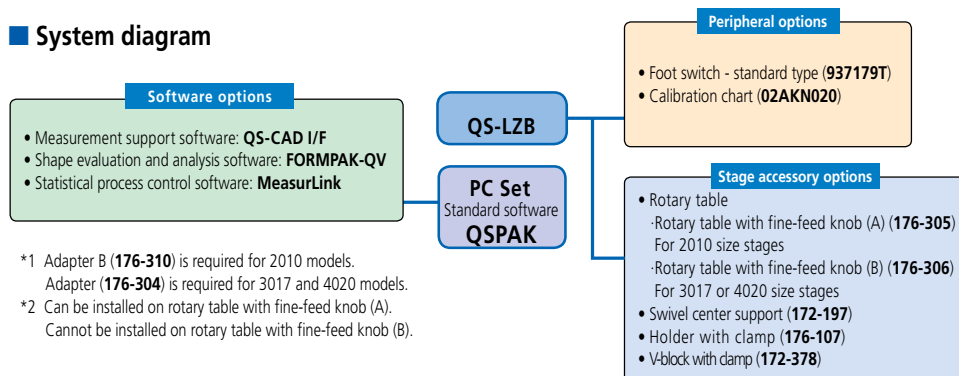

\*1 Adapter B (**176-310**) is required for 2010 models.  
Adapter (**176-304**) is required for 3017 and 4020 models.  
\*2 Can be installed on rotary table with fine-feed knob (A).  
Cannot be installed on rotary table with fine-feed knob (B).

### ■ Control Box



For QS-LZB

### ■ Optical system magnification ratios available for QS-LZB

Total magnification Field of View (mm)	29X 8.8x6.6	38X 6.8x5.1	49X 5.2x3.9	58X 4.4x3.3	87X 2.9x2.2	116X 2.2x1.6	145X 1.7x1.3	202X 1.2x0.9
<b>QS-LZB</b>	0.75X	0.98X	1.28X	1.5X	2.25X	3X	3.75X	5.25X
Working distance (mm)	55							

\* Total magnification shown in the above table is a reference value displayed in the default window state when using 22-inch LCD.

# Quick Image

## SERIES 361 — Non-contact 2-D Vision Measuring System

### Double-telecentric optics enable efficient measurement with a wide field of view

Batch measurement with a wide field of view 1.259" x 0.945" (32 x 24mm) realized using a 0.2X magnification model can substantially improve measurement efficiency. With a 0.5X magnification model, dimensions of very small workpieces and stepped workpieces easily can be measured.



Actual image acquired with a 0.2X magnification model

Quick Image is a new concept in 2-D vision measuring instruments. It provides unique features for improving measurement efficiency.

### FEATURES

- Long focal depth and wide field of view
- Telecentric optical system
- 3 mega-pixel color CCD camera
- Large quadrant LED ring light
- Single-click measurement execution
- Displays measurement results on video window
- Orientation of part is automatically detected



QI-A2010D



QI-C2010D

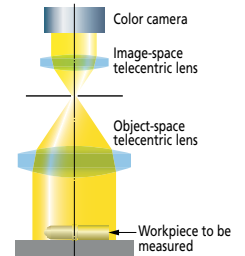

### SPECIFICATIONS

		Manual stage model					Motorized stage model		
0.2X	Model	QI-A1010D	QI-A2010D	QI-A2017D	QI-A3017D	QI-A4020D	QI-C2010D	QI-C2017D	QI-C3017D
0.5X	Model	QI-B1010D	QI-B2010D	QI-B2017D	QI-B3017D	QI-B4020D			
Measuring range (XxY)		3.94" x 3.94" 100x100mm	7.87" x 3.94" 200x100mm	7.87" x 6.69" 200x170mm	11.8" x 6.69" 300x170mm	15.7" x 7.87" 400x200mm	7.87" x 3.94" 200x100mm	7.87" x 6.69" 200x170mm	11.8" x 6.69" 300x170mm
Effective stage glass size		6.69" x 6.69" 170x170mm	9.53" x 5.51" 242x140mm	10.2" x 9.06" 260x230mm	14.2" x 9.06" 360x230mm	17.3" x 9.13" 440x232mm	9.53" x 5.51" 242x140mm	10.2" x 9.06" 260x230mm	14.2" x 9.06" 360x230mm
Maximum stage loading *1		Approx. 22 lbs.(10kg)		Approx. 44 lbs.(20kg)		Approx. 33 lbs. (15kg)	Approx. 22 lbs. (10kg)	Approx. 44 lbs.(20kg)	
Main unit mass		Approx. 143 lbs. 65kg	Approx. 152 lbs. 69kg	Approx. 330 lbs. 150kg	Approx. 348 lbs. 158kg	Approx. 361 lbs. 164kg	Approx. 158 lbs. 72kg	Approx. 337 lbs. 153kg	Approx. 354 lbs. 161kg

\*1 Does not include extremely offset or concentrated loads

		QI-A / QI-C		QI-B	
View field		1.26" x 0.94" (32x24mm)		0.50" x 0.378" (12.8x9.6mm)	
Measurement mode		High resolution mode / Normal mode *4			
Travel range (Z axis)		3.94"(100mm)			
Accuracy	Measurement accuracy within the screen *1	High resolution mode	±2µm		±1.5µm
		Normal mode	±4µm		±3µm
	Repeatability within the screen (±2σ) *2	High resolution mode	±1µm		±0.7µm
		Normal mode	±2µm		±1µm
	Measurement accuracy (E1xy) *1	±(3.5+0.02)µm L: arbitrary measuring length (mm)			
Monitor magnification *3		7.6X		18.9X	
Optical system	Magnification (Telecentric Optical System)	0.2X		0.5X	
	Depth of focus	High resolution mode	±0.6mm		±0.6mm
		Normal mode	±11mm		±1.8mm
Working distance	3.54"(90mm)				
Camera	3 million pixels, 1/2", full color				
illumination	Transmitted light: Green LED telecentric illumination Co-axial light: White LED Ring light: 4-quadrant white LED				
Power supply	100-240VAC 50/60Hz				
Accuracy guaranteed temperature range	19-21°C				

\*1 Inspected to Mitutoyo standards by focus point position.

\*2 The measuring accuracy is guaranteed to be accurate within the depth of focus.

\*3 For 1X digital zoom (when using the 22-inch-wide monitor)

\*4 Patent registered (Japan)

**Mitutoyo**

# QV Active

## Compact CNC Vision Measuring Systems

### FEATURES

- High-quality zoom optics with interchangeable lenses
- High-resolution and high-speed color camera
- Compact design saves significant space—available in two sizes
- Powerful QVPAK 3D vision software
- Contact and noncontact measurement
- Touch-probe retrofittable
- Programmable LED stage, coaxial and 4-quadrant ring light



1X, 1.5X and 2X interchangeable lens



QV Active 202

Optical magnification	0.5X	0.65X	0.75X	0.85X	0.98X	1X	1.28X	1.3X	1.5X	1.7X	2X	2.25X	2.5X	3X	3.5X	3.75X	4X	5X	5.25X	7X	
View field Horizontal (H) (mm)	13.60	10.46	9.07	8.00	6.94	6.80	5.31	5.23	4.53	4.00	3.40	3.02	2.72	2.27	1.94	1.81	1.70	1.36	1.30	0.97	
View field Vertical (V) (mm)	10.80	8.31	7.20	6.35	5.51	5.40	4.22	4.15	3.60	3.18	2.70	2.40	2.16	1.80	1.54	1.44	1.35	1.08	1.03	0.77	
Objective 1X Working distance																					
Objective 1.5X Working distance																					
Objective 2X Working distance																					

### SPECIFICATIONS

Name	Quick Vision Active	
Model No.	QV Active 202 / QV Active 202 TP	QV Active 404 / QV Active 404 TP
Range (X,Y,Z-axis) with vision head	9.84" x 7.87" x 5.91" 250 x 200 x 150 mm	15.75" x 15.75" x 7.87" 400 x 400 x 200 mm
Resolution	0.1 μm	
Accuracy (μm)*	$E_{1(X,Y)} = (2+3L/1000)$ $E_{1(Z)} = (3+5L/1000)$ $E_{2(X,Y)} = (2.5+4L/1000)$	
Max. stage loading	22 lbs. (10 kg)	44 lbs. (20 kg)
Mass	265 lbs. (120 kg)	606 lbs. (275 kg)
Illumination	(White LED) Contour / Coaxial / 4-quadrant ring light	
Magnification change system	Zoom optical system with 8 positions (Standard 1.5X magnification lens)	
Sensor type	High-resolution CMOS color camera	
Optional objective lenses	1X and 2X magnification	
Factory option	Series 364 (TP) Touch-Probe option (Page M-13)	

\* L is arbitrary length in mm

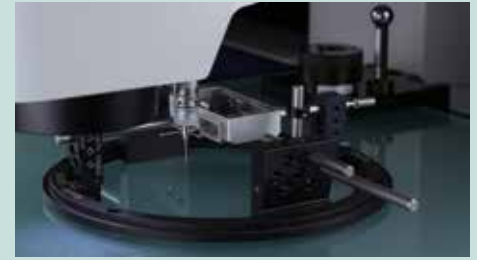

### Touch-Probe System

The QV touch-probe system is available on all the models. All touch-probe systems include probes, modules, calibration articles and installed software. (See page M-13)

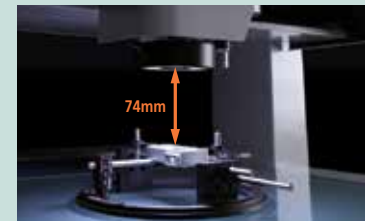

Long working distance 74mm  
\*when using Z-objective 1X

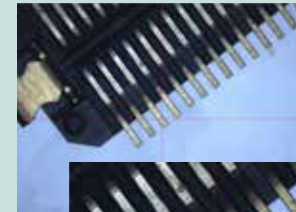

0.75X

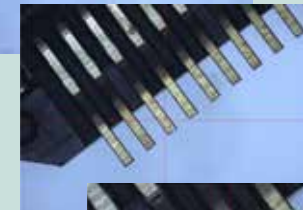

1.28X

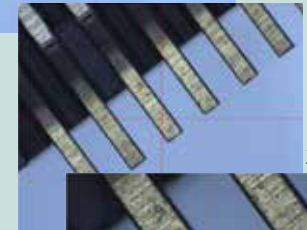

2.25X

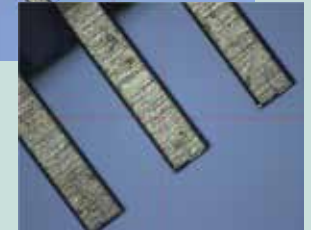

5.25X

8 steps high speed zoom

## Image Multi-AutoFocus

The optimal focus can be selected for each surface texture and measured feature, realizing high reproducibility and reliable edge detection.

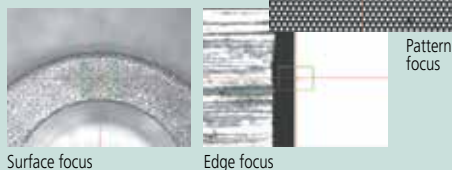

## Programmable Ring Light (PRL)

Fine control of obliquity and direction provides illumination optimal for measurement. Obliquity can be arbitrarily set in the range from 30° to 80°. This type of illumination is effective for enhancing the edge of inclined surfaces or very small steps. Illumination can be controlled independently in every direction, front and back, right and left. Measurement with edge enhancement is possible by forming a shadow with lighting from only one direction.

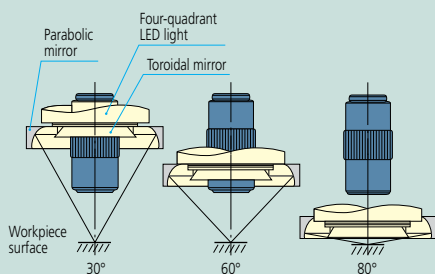

## Tracking Auto Focus (TAF)

The TAF feature focuses continuously, adjusting to changes in the height of the object being measured. Automatic tracking of surface waves and warpage (in the Z axis height direction) improves measurement throughput. The feature also eliminates the hassle of focusing during manual measurement.

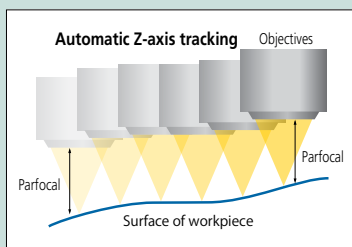

### Tracking Auto Focus (TAF)

AF principle	Objective coaxial autofocusing (knife-edge method)				
Suitable objectives	QV-HR1x	QV-SL1x	QV-HR2.5x	QV-SL2.5x	QV-5x
Tracking range*2	6.3mm (±3.15mm)	6.3mm (±3.15mm)	1mm (±0.5 mm)	1mm (±0.5 mm)	0.25mm (±0.125mm)
Spot diameter*3	5.2µm	8.0µm	2.1µm	3.1µm	1.5µm
Laser source	Semiconductor laser (peak wavelength: 690nm)				
Laser power	0.9mW				
Laser safety	Class 2 (JIS C6802:2011, EN/IEC 60825-1:2007)				

\*2 Varies according to workpiece surface texture and reflectance.  
\*3 These are design values.

Optional Accessories: Refer to page M-14.

# QV Apex

## SERIES 363 — CNC Vision Measuring System



QV Apex 302 PRO



QV Apex 606 PRO

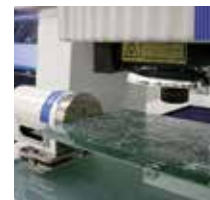

### Optional Index Table\*

Automatic multi-plane measurement is possible with the optional index table. Refer to page M-14 for more details.  
\*Not available with QV ACCELL models

## SPECIFICATIONS

Name	Quick Vision Apex			
	QV Apex 302 PRO	QV Apex 404 PRO	QV Apex 606 PRO	
	QV Apex 302 (ISO10360-7)	QV Apex 404 (ISO10360-7)	QV Apex 606 (ISO10360-7)	
Model No.	QV Apex 302 (w/TAF)	QV Apex 404 (w/TAF)	QV Apex 606 (w/TAF)	
Measuring Range	X-axis	11.81" / 300mm	15.75" / 400mm	23.62" / 600mm
	Y-axis	7.87" / 200mm	15.75" / 400mm	25.59" / 650mm
	Z-axis	7.87" / 200mm	9.84" / 250mm	9.84" / 250mm
Resolution / Scale Unit	0.1µm / Reflective-type Linear Encoder			
Resolution Z Scale Using Tracking Autofocus (TAF)	0.3 µm			
Laser Auto Focus repeatability $\sigma \leq$	0.8 µm			
CCD camera	B & W			
Illumination Unit (LED)	Surface	White LED		
	Contour	White LED		
	Programmable Ring Light	White LED		
Max. Drive Speed	X/Y Axis	300 mm/s	400 mm/s	
	Z-Axis	300 mm/s	300 mm/s	
Measuring Accuracy*	$E_{IX}, E_{IY}$	(1.5+3L/1000)µm		
	$E_{IZ}$	(1.5+4L/1000)µm		
	$E_{2XY}$	(2+4L/1000)µm		
	$E_{U,MPE}$ (ISO10360-7:2011)	3+5.5L/1000, 3+6L/1000**		
	$P_{F2D,MPE}$ (ISO10360-7:2011)	2.3µm		
Magnification Change System	Programmable Power Turret (1x, 2x, 6x)			
Stage Glass Size	15.71" x 10.67" (399 x 271mm)	19.41" x 21.69" (493 x 551mm)	27.44" x 29.84" (697 x 758mm)	
Maximum Stage Loading	44 lbs. (20kg)	88 lbs. (40kg)	110 lbs. (50kg)	
Dimensions of Main Unit	37.44" x 33.82" x 41.06" (951 x 859 x 1043mm)	55.39" x 40.43" x 54.37" (1407 x 1027 x 1381mm)	78.15" x 51.54" x 61.81" (1985 x 1309 x 1570mm)	
Mass of Main Unit (Including Machine Stand)	794 lbs. (360kg)	1276 lbs. (579kg)	3197 lbs. (1450kg)	

\*The measuring accuracy defined under the following conditions:

Programmable Power Turret: 2x Position; Objective Lens: 2.5x (HR or SL); L=Dimension between two arbitrary points (mm)

\*\*Accuracy 3.5+5.5L/1000 for 20 ± 2°C, Accuracy 3+6L/1000 from 18 to 23°C

# QV Stream Plus

## SERIES 363 — CNC Vision Measuring System



QV Stream Plus 606 PRO

### STREAM MODE

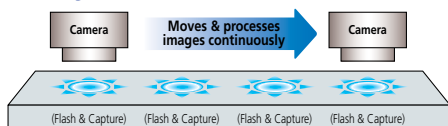

### High-density mounting of ultra-high intensity LED elements

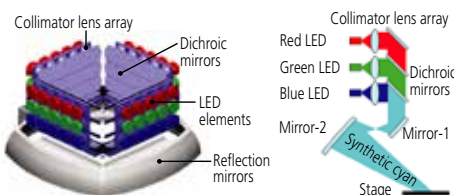

## SPECIFICATIONS

Name		Quick Vision Stream Plus		
Model No.		QV Stream Plus 302 PRO	QV Stream Plus 404 PRO	QV Stream Plus 606 PRO
		QV Stream Plus 302 (w/TAF)	QV Stream Plus 404 (w/TAF)	QV Stream Plus 606 (w/TAF)
Measuring Range	X-axis	11.81" / 300mm	15.75" / 400mm	23.62" / 600mm
	Y-axis	7.87" / 200mm	15.75" / 400mm	25.59" / 650mm
	Z-axis	7.87" / 200mm	9.84" / 250mm	9.84" / 250mm
Resolution / Scale Unit		0.1 μm / Reflective-type Linear Encoder		
Resolution Z Scale Using Tracking Autofocus (TAF)		0.3 μm		
Laser Auto Focus repeatability $\sigma \leq$		0.8 μm		
CCD camera		B & W, Progressive Scanning CCD		
Illumination Unit (C: Continuous; S: Stroboscopic; PRL: Programmable Ring Light)	Surface (C)	Red, Green, Blue & White (LED)		
	Surface (S)	Blue (LED)		
	Contour (C)	Blue (LED)		
	Contour (S)	Blue (LED)		
	PRL (C)	Red, Green, Blue & White (LED)		
	PRL (S)	Blue (LED)		
Max. Drive Speed		X/Y/Z Axis 300 mm/s		
Measuring Accuracy*	$E_{1X}, E_{1Y}$	(1.5+3L/1000) μm		
	$E_{1Z}$	(1.5+4L/1000) μm		
	$E_{2XY}$	(2+4L/1000) μm		
Magnification Change System		Programmable Power Turret (1x, 2x, 6x)		
Stage Glass Size		15.71" x 10.67" (399 x 271mm)	19.41" x 21.69" (493 x 551mm)	27.44" x 29.84" (697 x 758mm)
Maximum Stage Loading		44 lbs. (20kg)	88 lbs. (40kg)	110 lbs. (50kg)
Dimensions of Main Unit		37.44" x 33.82" x 41.06" (951 x 859 x 1043mm)	55.39" x 40.43" x 54.37" (1407 x 1027 x 1381mm)	78.15" x 51.54" x 61.81" (1985 x 1309 x 1570mm)
Mass of Main Unit (Including Machine Stand)		794lbs. (360kg)	1276 lbs. (579kg)	3197 lbs. (1450kg)

\*The measuring accuracy defined under the following conditions:  
Programmable Power Turret: 2x Position; Objective Lens: 2.5x (HR or SL); L=Dimension between two arbitrary points (mm)

## FEATURES

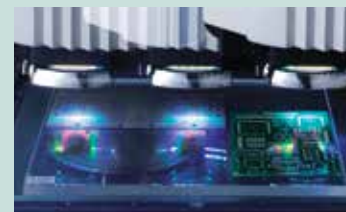

### Non-stop Vision Measurement Extreme Improvement in Throughput\*

Conventional vision measuring systems endlessly repeat the cycle of stage displacement, stage stop, measurement, stage start and stage displacement. This mode of operation is a fundamental limitation on improving measurement throughput.

In contrast, the Quick Vision Stream system uses an innovative image capture technique that avoids the need to repeatedly stop the stage, thereby allowing for continuous measurement while still maintaining accuracy.

### Measurement Throughput Comparison between QV STREAM and the Conventional System

STREAM PLUS series: more than 5 times faster

\* Comparison of measurement throughput using a Mitutoyo sample workpiece with that of conventional Mitutoyo systems.

### Newly Developed Stroboscopic Illumination System

The development of a high-intensity LED flash illuminator makes non-stop vision measurement possible. At the precise moment the stage reaches a measurement point, the illuminator creates an extremely short, high-intensity flash that effectively freezes all motion. The illuminator turns on and off so quickly that no image blur occurs, and the image is captured in full and accurate detail.

This innovative design takes full advantage of high-density, high-intensity LED arrays aided by collimating lenses and dichroic mirrors to produce ultra bright, directional and efficient illumination.

### Tracking Auto Focus (TAF)

The TAF feature continuously focuses, adjusting to changes in the height of the object being measured. Automatic tracking of surface waves and warpage (in the Z axis height direction) improves measurement throughput. The feature also cuts out the hassle of focusing during manual measurement, reducing the work burden for measuring system operators.

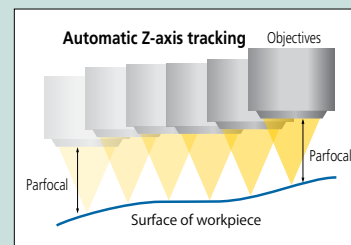

### Tracking Auto Focus (TAF)

AF principle	Objective coaxial autofocusing (knife-edge method)				
Suitable objectives	QV-HR1x	QV-SL1x	QV-HR2.5x	QV-SL2.5x	QV-5x
Tracking range*2	6.3mm (±3.15mm)	6.3mm (±3.15mm)	1mm (±0.5 mm)	1mm (±0.5 mm)	0.25mm (±0.125mm)
Spot diameter*3	5.2 μm	8.0 μm	2.1 μm	3.1 μm	1.5 μm
Laser source	Semiconductor laser (peak wavelength: 690nm)				
Laser power	0.9mW				
Laser safety	Class 2 (JIS C6802:2011, EN/IEC 60825-1:2007)				

\*2 Varies according to workpiece surface texture and reflectance.

\*3 These are design values.

### Programmable Power Turret (PPT)

The three tube lens selection provides three magnification levels with the same objective lens. Replacement objective lenses allow a wide range of magnifications to support a variety of measurements.



1X tube lens x 2.5X objective  
View field: 2.5 x 1.88 mm

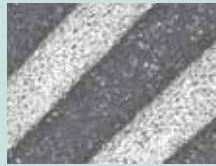

2X tube lens x 2.5X objective  
View field: 1.25 x 0.94 mm



6X tube lens x 2.5X objective  
View field: 0.41 x 0.31 mm

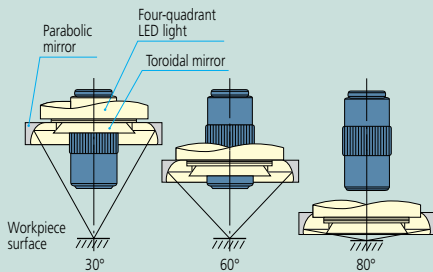

### Programmable Ring Light (PRL)

Fine control of obliquity and direction provides illumination optimal for measurement. Obliquity can be arbitrarily set in the range from 30° to 80°. This type of illumination is effective for enhancing the edge of inclined surfaces or very small steps. Illumination can be controlled independently in every direction, front and back, right and left. Measurement with edge enhancement is possible by forming a shadow by lighting from only one direction.

# QV Hyper

## SERIES 363 — High-accuracy CNC Vision Measuring System



QV Hyper 404 PRO

### SPECIFICATIONS

Name		Quick Vision Hyper		
		QV Hyper 302 PRO	QV Hyper 404 PRO	QV Hyper 606 PRO
Model No.		QV Hyper 302 (ISO10360-7)	QV Hyper 404 (ISO10360-7)	QV Hyper 606 (ISO10360-7)
		QV Hyper 302 (w/TAF)	QV Hyper 404 (w/TAF)	QV Hyper 606 (w/TAF)
	Measuring Range	X-axis Y-Axis Z-Axis	11.81" / 300mm 7.87" / 200mm 7.87" / 200mm	15.75" / 400mm 15.75" / 400mm 9.84" / 250mm
Resolution / Scale Unit		0.02µm / Reflective-type Linear Encoder		
Resolution Z Scale using Tracking Autofocus (TAF)		0.26 µm		
Laser Auto Focus repeatability $\sigma \leq$		0.8 µm		
CCD Camera		B & W		
Illumination Unit (LED)	Surface	White LED		
	Contour	White LED		
	Programmable Ring Light	White LED		
Max. Drive Speed	XYZ-Axis	200mm/s		
Measuring Accuracy*	$E_{1X}, E_{1Y}$	(0.8+2L/1000)µm		
	$E_{1Z}$	(1.5+2L/1000)µm		
	$E_{2XY}$	(1.4+3L/1000)µm		
	$E_{U,MPE}$ (ISO10360-7:2011)	2.5+4L/1000, 2.5+4.5L/1000**		
	$P_{F2D,MPE}$ (ISO10360-7:2011)	1.7µm		
Magnification Change System		Programmable Power Turret (1x, 2x, 6x)		
Stage Glass Size		15.71" x 10.67" (399 x 271mm)	19.41" x 21.69" (493 x 551mm)	27.44" x 29.84" (697 x 758mm)
Maximum Stage Loading		44 lbs. (20kg)	88 lbs. (40kg)	110 lbs. (50kg)
Dimensions of Main Unit		37.44" x 33.82" x 41.06" (951 x 859 x 1043mm)	55.39" x 40.43" x 54.37" (1407 x 1027 x 1381mm)	78.15" x 51.54" x 61.81" (1985 x 1309 x 1570mm)
Mass of Main Unit (Including Machine Stand)		794 lbs. (360kg)	1276 lbs. (579kg)	3197 lbs. (1450kg)

\*The measuring accuracy defined under the following conditions:

Programmable Power Turret: 2x Position; Objective Lens: 2.5x (HR or SL); L=Dimension between two arbitrary points (mm)

\*\*Accuracy 2.5+4L/1000 for 20 ± 2°C, Accuracy 2.5+4.5L/1000 from 18 to 23°C

# QV Hybrid Type 1, Type 4

## SERIES 365 — CNC Vision Measuring System with Non-contact Displacement Sensor

### FEATURES

The Quick Vision Hybrid is an advanced machine that allows vision measurement with both a CCD camera and high-speed scanning by applying a vision measurement unit in parallel with a non-contact displacement sensor.



Type 4 Displacement Sensor

QVH 606

### FEATURES: Hybrid Type 1

- The focusing point method minimizes the difference in the measuring face reflectance and realizes high measurement reproducibility.
- The double pinhole method (less directivity) is employed as the measurement principle.

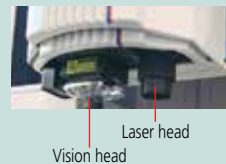

**CLASS 1 LASER PRODUCT**

### Safety precautions regarding laser autofocus system (factory-installed option)

This product uses a low-power visible laser (690nm) for measurement. The laser is a CLASS 1 EN/IEC60825-1 (2007) device. A warning and explanation label, as shown above, is attached to the product as appropriate.

### SPECIFICATIONS

Name		Quick Vision Hybrid 302		Quick Vision Hybrid 404		Quick Vision Hybrid 606		
Model No.		QVH Apex 302 (ISO10360-7)	QV Hyper 302 (ISO10360-7)	QVH Apex 404 (ISO10360-7)	QV Hyper 404 (ISO10360-7)	QVH Apex 606 (ISO10360-7)	QV Hyper 606 (ISO10360-7)	
		QVH STREAM 302		QVH STREAM 404		QVH STREAM 606		
Measuring Range (XxYxZ)	Vision	11.81" x 7.87" x 7.87" (300x200x200mm)		15.75" x 15.75" x 9.84" (400x400x250mm)		23.62" x 25.59" x 9.84" (600x650x250mm)		
	Non-contact Displacement Sensor	TYPE1	7.09" x 7.87" x 7.87" (180x200x200mm)	11.02" x 15.75" x 9.84" (280x400x250mm)		18.90" x 25.59" x 9.84" (480x650x250mm)		
Measuring Accuracy	(Vision) <sup>2*3</sup>	TYPE4*1	6.92" x 7.87" x 7.87" (176x200x200mm)	10.87" x 15.75" x 9.84" (276x400x250mm)		18.74" x 25.59" x 9.84" (476x650x250mm)		
		E1X, E1Y	(1.5+3L/1000)µm	(0.8+2L/1000)µm	(1.5+3L/1000)µm	(0.8+2L/1000)µm	(1.5+3L/1000)µm	(0.8+2L/1000)µm
		E1Z	(1.5+4L/1000)µm	(1.5+2L/1000)µm	(1.5+4L/1000)µm	(1.5+2L/1000)µm	(1.5+4L/1000)µm	(1.5+2L/1000)µm
	(Displacement Sensor) <sup>2*3</sup>	E2XY	(2.0+4L/1000)µm	(1.4+3L/1000)µm	(2.0+4L/1000)µm	(1.4+3L/1000)µm	(2.0+4L/1000)µm	(1.4+3L/1000)µm
		E1Z	(1.5+4L/1000)µm	(1.5+2L/1000)µm	(1.5+4L/1000)µm	(1.5+2L/1000)µm	(1.5+4L/1000)µm	(1.5+2L/1000)µm
		(ISO10360-7:2011)	E <sub>L,MPF</sub>	3+5.5L/1000 <sup>4</sup> 3+6.0L/1000 <sup>5</sup>	2.5+4L/1000 <sup>4</sup> 2.5+4.5L/1000 <sup>5</sup>	3+5.5L/1000 <sup>4</sup> 3+6.0L/1000 <sup>5</sup>	2.5+4L/1000 <sup>4</sup> 2.5+4.5L/1000 <sup>5</sup>	3+5.5L/1000 <sup>4</sup> 3+6.0L/1000 <sup>5</sup>
	P <sub>F2D,MPF</sub>	2.3µm	1.7µm	2.3µm	1.7µm	2.3µm	1.7µm	
Scale Resolution		0.1µm	0.02µm	0.1µm	0.02µm	0.1µm	0.02µm	
Max. Drive Speed	XYZ Axis	300 mm/s	200 mm/s	300 mm/s	200 mm/s	300 mm/s	200 mm/s	
Stage Glass Size		15.71" x 10.67" (399 x 271mm)		19.41" x 10.67" (493 x 551mm)		27.44" x 29.84" (697 x 758mm)		
Maximum Stage Loading		44 lbs. (20kg)		88 lbs. (40kg)		110 lbs. (50kg)		
Dimensions of Main Unit		37.44" x 33.82" x 41.06" (951 x 859 x 1043mm)		55.39" x 40.43" x 54.37" (1407 x 1027 x 1381mm)		78.15" x 51.54" x 61.81" (1985 x 1309 x 1570mm)		
Mass of Main Unit (Including Machine Stand)		794 lbs. (360kg)		1276 lbs. (579kg)		3197 lbs. (1450kg)		

Name		Quick Vision ACCEL			
Model No.		QVH ACCEL808	QVH ACCEL 1010	QVH ACCEL 1212	QVH ACCEL 1517
Measuring Range (XxYxZ)	Vision	31.50x31.50x5.91" (800x800x150mm)	39.37x39.37x5.91" (1000x1000x150mm)	49.21x49.21x3.94" (1250x1250x100mm)	59.06x68.90x3.94" (1500x1750x100mm)
	Non-contact Displacement Sensor	TYPE1	26.77x31.50x5.91" (680x800x150mm)	34.65x39.37x5.91" (880x1000x150mm)	44.49x49.21x3.94" (1130x1250x100mm)
Measuring Accuracy	(Vision) <sup>2*3</sup>	E1X, E1Y	(1.5+3L/1000)µm		(2.2+3L/1000)µm
		E1Z	(1.5+4L/1000)µm		(2.5+5L/1000)µm
		E2XY	(2.5+4L/1000)µm		(3.5+4L/1000)µm
(Displacement Sensor) <sup>2*3</sup>	E1Z	(2.5+4L/1000)µm		(3.5+5L/1000)µm	
	Scale Resolution	0.1µm			
Max. Drive Speed	XY Axis	400 mm/s		300 mm/s	
	Z Axis	150 mm/s		150 mm/s	
Stage Glass Size		34.76" x 37.72" (883x958mm)	46.69" x 46.69" (1186x1186mm)	56.69" x 56.69" (1440x1440mm)	67.48" x 77.48" (1714x1968mm)
Maximum Stage Loading		22 lbs. (10kg)		66 lbs. (30kg)	
Dimensions of Main Unit		58.07" x 73.23" x 62.13" (1475 x 1860 x 1578mm)	75.28" x 84.29" x 63.11" (1912 x 2141 x 1603mm)	85.28" x 93.31" x 61.18" (2166 x 2370 x 1554mm)	96.06" x 114.09" x 61.18" (2440 x 2898 x 1554mm)
Mass of Main Unit		4519 lbs. (2050kg)	6504 lbs. (2950kg)	7937 lbs. (3600kg)	9921 lbs. (4500kg)

\*1 TYPE 4 is not supported by QVH STREAM

\*2 L = arbitrary measuring length (mm)

\*3 Inspected by Mitutoyo standard

\*4 Accuracy for 20 ± 2°C

\*5 Accuracy from 18 to 23°C

### FEATURES: Hybrid Type 4

- Enables detection of high inclination angles for both mirror and diffused surfaces.
- The automatic lighting adjustment function allows for high-accuracy measurements.
- Thickness measurement of thin and transparent objects such as film.

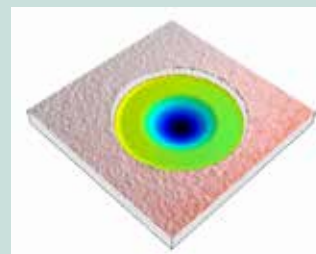

3-dimensional topographical result, data of plastic package by MCubeMAP

Common Specifications	QV Apex	QV Hyper	QV Accel	QV Stream
CCD camera	Black & White			Black & White; Progressive Scanning
Magnification Change System	Programmable Power Turret (1x, 2x, 6x)			
Guide Method	Linear Motion Hard Bearing			
Illumination (Catalog Page Number Reference)	M-5	M-7	M-12	M-6

\* Specification of QVH1 ACCEL



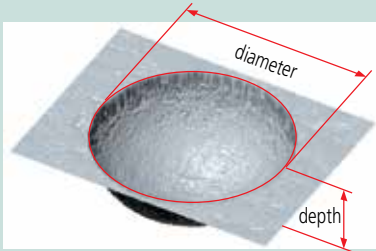

Application view of nano hole

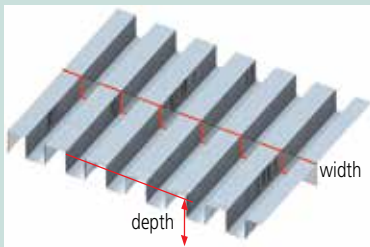

Application view of surface trace

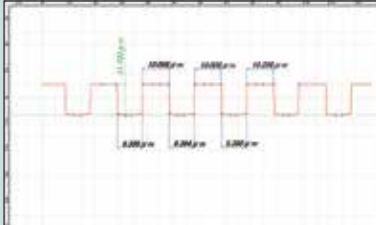

FormTracePak AP

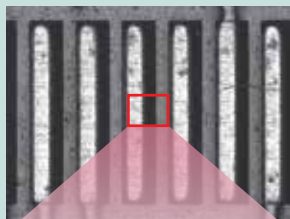

Region of interest evaluation



3-dimensional topographical result, data of micro-circuit

# QV WLI

## SERIES 363 — CNC Video Measuring System with White Light Interferometry

- QV WLI can measure coordinates and dimensions and assess micro-3D forms without contact.
- High-accuracy, dual-head vision measuring system equipped with a white light interferometer.
- The white light interferometer uses a high aspect ratio to accurately measure shapes.
- The standard vision measuring function can continuously perform coordinate, dimension and 3D shape measuring.
- Large work stage accurately handles over-sized work pieces such as a PCB.

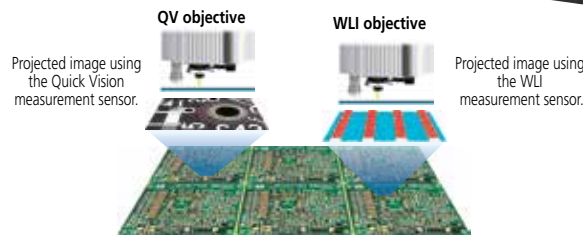

### SPECIFICATIONS

Name	QV Hyper WLI 302	QV Hyper WLI 404	QV Hyper WLI 606
Model No.	QV Hyper WLI 302 (ISO10360-7)	QV Hyper WLI 404 (ISO10360-7)	QV Hyper WLI 606 (ISO10360-7)
Measuring Range (XxYxZ)	Vision Measuring Area	11.81" x 7.87" x 7.48" (300x200x190mm)	15.75" x 15.75" x 9.45" (400x400x240mm)
	WLI Measuring Area*1	8.46" x 7.87" x 7.48" (215x200x190mm)	12.40" x 15.75" x 9.44" (315x400x240mm)
<b>WLI Optical Head Unit</b>			
Field of View (HxV)	5X lens: approx. 0.64x0.48mm / 10X lens: approx. 0.32x0.24mm / 25X lens: approx. 0.13x0.10mm		
Illumination	Co-axial Light	Halogen	
Repeatability	2σ ≤ .08μm		
Z-axis Scanning Range*2	170μm		
<b>Vision Optical Head Unit</b>			
Magnification Change System	Programmable Power Turret (1X-2X-6X)		
Image Detection Method	B&W CCD camera		
Illumination	Co-axial Light	White LED	
	Transmitted Light	White LED	
	Programmable Ring Light	White LED	
Measuring Accuracy	E1X, E1Y	(0.8+2L/1000)μm	
	E1Z	(1.5+2L/1000)μm	
	E2XY	(1.4+3L/1000)μm	
	E <sub>U,MPE</sub> (ISO10360-7:2011)	2.5+4L/1000	
	P <sub>F2D,MPE</sub> (ISO10360-7:2011)	1.7μm	
<b>Main Unit</b>			
Resolution	0.01μm		
Max. Stage Loading	33 lbs. (15kg)	55 lbs. (25kg)	77 lbs. (35kg)
Guidance System	Linear Motion Hard Bearing		
Dimensions (WxDxH)	33.82" x 37.40" x 63.23" (859x950x1606mm)	40.43" x 55.39" x 70.11" (1027x1407x1781mm)	51.54" x 78.15" x 70.55" (1309x1985x1792mm)
Mass (Vibration Isolator Stand Included)	Approx. 1080 lbs. (490kg)	Approx. 2557 lbs. (1160kg)	Approx. 2275 lbs. (1031kg)

\*1: WLI head is moveable. Multiple fields of view can be stitched together.  
\*2: In standard mode. Applicable to max. 200μm by modifying scan pitch.

# ULTRA QV

## SERIES 363 — Ultra-high Accuracy CNC Vision Measuring System

### FEATURES

- Minimizes straightness errors through the use of a precision air-bearing linear guide system.
- Utilizes a 0.01µm resolution glass scale manufactured at an ultra-precision facility located 11 meters underground.
- In order to minimize error caused by temperature fluctuations, the linear encoder scale is made of special crystallized glass with an expansion coefficient that is almost zero.
- Optimizes the mechanical structure of the main unit in Finite Element Method analysis.
- Stabilizes the geometrical accuracy (i.e. straightness of each axis and perpendicularity) to lessen thermal effects.



### SPECIFICATIONS

Model No.	ULTRA QV 404 PRO	ULTRA QV 404 PRO w/ TAF
	ULTRA QV 404 PRO (ISO10360-7:2011)	ULTRA QV 404 PRO w/ TAF (ISO10360-7:2011)
Range	X x Y x Z 16" x 16" x 8" (400x400x200mm)	
Magnification Change System	Programmable Power Turret (Selectable from Magnifications of 1X, 2X and 6X)	
Resolution / Scale Unit	0.01µm / Linear Encoder <sup>4</sup>	
Resolution of Z-Scale Using TAF	-	0.25µm
High-sensitivity CCD Camera	B&W	
Illumination (PRL: Programmable Ring Light)	Surface	Halogen
	Contour	Halogen
	PRL	Halogen
Accuracy <sup>*1</sup> (20°C±0.2°C)	E1XY	(0.25+L/1000)µm
	E1Z (50mm Stroke) <sup>*2</sup>	(1.0+2L/1000)µm
	E1Z (Full Stroke)	(1.5+2L/1000)µm
	E2XY Plane	(0.5+2L/1000)µm
	E <sub>U,MPE</sub> (ISO10360-7:2011)	1.3+3L/1000, 1.3+3.5L/1000 <sup>*5</sup>
	P <sub>F2D,MPE</sub> (ISO10360-7:2011)	1.0µm
Accuracy Assurance Environments <sup>*3</sup>	Temperature Range	20±0.2°C
	Temperature Variation	0.5°C/1H
	Temperature Gradient	1°C/m
Repeatability within the Visual Field	3σ=0.2µm	
Repeatability of Auto-focus	σ=0.4µm	
Stage Glass Size	19.4" x 21.7" (493x551mm)	
Max. Stage Loading	88lb (40kg)	
Dimensions (W x D x H)	46" x 68" x 75.2" (1172x1735x1910mm)	
Mass	4464 lb (2025kg)	
Used Air Pressure	0.4MPa <sup>*6</sup>	
Supplied Air Flow Rate	150L/min <sup>*7</sup>	

\*1: Accuracy when measured at the center of the video screen and in the middle of measuring stroke on a plane using the 5X objective and 1X tube lens  
 \*2: Specified only for factory shipping inspection.  
 \*3: Accuracy assurance environments in the case where no temperature compensation is performed.

Those in the case where temperature compensation is performed are as follows.  
 - Accuracy-assured temperature range: 20±2°C  
 - Temperature variation: 0.5°C/H  
 - Temperature gradient: 1°C/m  
 \*4: Thermal expansion coefficient: (0±0.02)X10-6/K

\*5: Accuracy 1.3+3L/1000 for 20 ± 2°C, Accuracy 1.3+3.50L/1000 from 18 to 23°C  
 \*6: An air source is required to maintain the original air pressure between 0.5 and 0.9MPa.  
 \*7: Indicates the flow rate under normal conditions.

### Self-Suction Air Pad

If a normal air pad is used for the Y axis, it is necessary to increase the mass of the work stage to obtain appropriate rigidity. ULTRA QV (Quick Vision) employs a special air pad called a self-suction type that floats the air pad using compressed air and also generates an absorption power with a vacuum zone provided under negative pressure at the center of the pad. This achieves greater Y-axis rigidity and stage weight reduction concurrently, thus enabling stable stage drive.

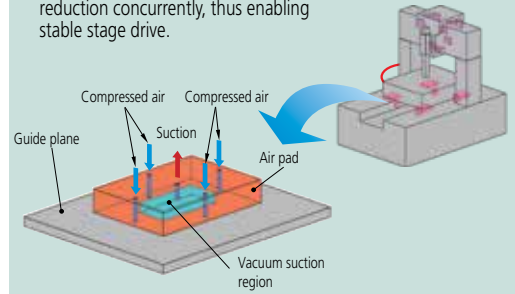

### Ball Screw Floating Mechanism

ULTRA QV employs high-reliability ball screws in the floating mechanism. This floating mechanism will minimize the error due to axial fluctuation that adversely affects kinetic performance, such as straightness, and improves the driving speed.

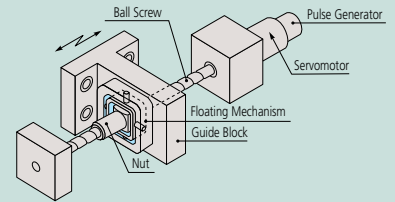

Ultra-high accuracy crystallized glass scale with virtually zero thermal expansion

The ULTRA Quick Vision is equipped with a crystallized glass scale having a resolution of 0.01µm and linear expansion coefficient of ±0.02x10<sup>-6</sup>/K. Virtually zero thermal expansion means the ULTRA Quick Vision can minimize accuracy fluctuation resulting from thermal changes.

### Tracking Auto Focus (TAF)

The TAF feature focuses continuously, adjusting to changes in the height of the object being measured. Automatic tracking of surface waves and warpage (in the Z axis) improves measurement throughput. The feature also cuts out the hassle of focusing during manual measurement and reduces the burden for the operator.

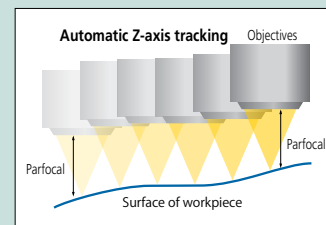

# UMAP Vision System TYPE2

## SERIES 364 — Micro-form Measuring System

### FEATURES

#### • Ultrasonic micro probe, UMAP

The ultrasonic micro probe (UMAP) has the ability to sense the amplitude variability in a micro area, and the optional contact points (15 to 300 $\mu$ m diameter) provide high-accuracy measurements to meet a variety of specifications.

#### • High-accuracy contact and non-contact measurement capabilities in one system

This unit includes the UMAP and the non-contact type vision head. Until now, it was difficult to measure minute areas, but it is now possible to do both contact and non-contact measurement on a single platform.



HYPER UMAP Vision System 302 TYPE2



ULTRA UMAP Vision System 404 TYPE2

### Application examples

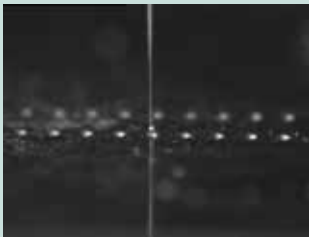

Contour measurement of a  $\phi 0.125$  hole



Measuring form of micro gear teeth

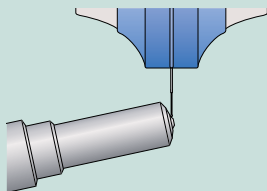

Measurement of a fuel injection nozzle hole's shape

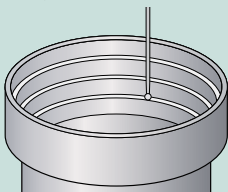

Measurement of a lens barrel's shape



Micro probe, UMAP

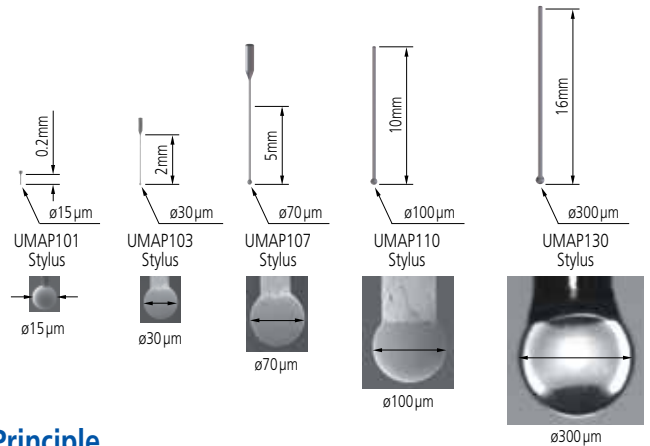

### Detection of Surface Principle

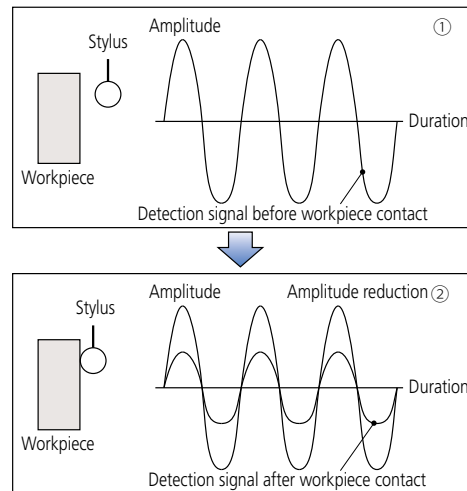

- ① In this drawing, the stylus is vibrating with a micro amplitude. When it does not come into contact with the workpiece, the vibration state is maintained.
- ② As the stylus comes into contact with the workpiece, the vibration amplitude decreases as the contact increases. When the decreasing amplitude falls below a certain level, a touch-trigger signal is generated.

### SPECIFICATIONS

		TYPE2	
		Hyper UMAP302	ULTRA UMAP404
Measuring range (common to vision and UMAP)	X-axis x Y-axis	7.28 x 7.87" (185x200mm)	11.22 x 15.75" (285x400mm)
	Z-axis	6.89" (175mm): UMAP101/103 7.07" (180mm): UMAP107/110 7.28" (185mm): UMAP130	
Measuring accuracy (Vision)	$E_{1X}, E_{1Y}$	(0.8+2L/1000) $\mu$ m	(0.25+L/1000) $\mu$ m
	$E_{1Z}$	(1.5+2L/1000) $\mu$ m	
Repeatability	UMAP 101/103/107	$\sigma = 0.1 \mu$ m	$\sigma = 0.08 \mu$ m
	UMAP 110/130	$\sigma = 0.15 \mu$ m	$\sigma = 0.12 \mu$ m

# QV ACCEL

## SERIES 363 — Large-format CNC Vision Measuring System

### FEATURES

#### Moving-bridge type structure

Designed with primary focus on measurement efficiency, the machine drives the X and Y axes at 400mm/s (QV ACCEL808, ACCEL1010).

The moving-bridge type structure eliminates the need for a moving stage. This facilitates a more simplified design of the workpiece fixture, resulting in a significant reduction in the man-hours required for fixture fabrication and inspection.



### SPECIFICATIONS

Model No.		QV ACCEL 808 PRO	QV ACCEL 1010 PRO	QV ACCEL 1212 PRO	QV ACCEL 1517 PRO
Range	X-axis	32" / 800mm	40" / 1000mm	50" / 1250mm	60" / 1500mm
	Y-axis	32" / 800mm	40" / 1000mm	50" / 1250mm	70" / 1750mm
	Z-axis	6" / 150mm	6" / 150mm	4" / 100mm	4" / 100mm
Resolution		0.1µm			
Resolution of Z Scale using TAF		0.3µm			
High-sensitivity CCD camera		B&W			
Accuracy*	E1xy	(1.5+3L/1000)µm		(2.2+3L/1000)µm	
	E1z	(1.5+4L/1000)µm		(2.5+5L/1000)µm	
	E2xy	(2.5+4L/1000)µm		(3.5+4L/1000)µm	
Max. Drive Speed	X/Y-axis	400mm/s		300mm/s	
	Z-axis	150mm/s		150mm/s	
Illumination (PRL: Programmable Ring Light)	Surface	LED, white			
	Contour	LED, white			
	PRL	LED, white (4 divisions)			
Magnification Change System		Programmable Power Turret (1X, 2x, 6x)			
Stage Glass Size		34.8" x 37.7" 883 x 958mm	46.7" x 46.7" 1186 x 1186mm	56.7" x 56.7" 1440 x 1440mm	67.5" x 77.5" 1714 x 1968mm
Dimensions (W x D x H)		58 x 67.5 x 62" 1475x1716x1578mm	75.3 x 82 x 63" 1912x2086x1603mm	85.3 x 92 x 61" 2166x2340 x1554mm	96 x 113 x 61" 2440 x 2868 x 1554mm
Max Stage Loading		22 lbs / 10kg	66.1 lbs / 30kg	66.1 lbs / 30kg	66.1 lbs / 30kg
Mass		5666 lbs / 2570kg	6504 lbs / 2950kg	7937 lbs / 3600kg	9921 lbs / 4500kg

\* The measuring accuracy is defined at the following conditions, Programmable power turret: 1X, Objective lens: 2.5X (HR or SL), L = Dimension between two arbitrary points (mm)

#### Image Multi-AutoFocus

The optimal focus can be selected for each surface texture and measured feature, providing high reproducibility and reliable edge detection.

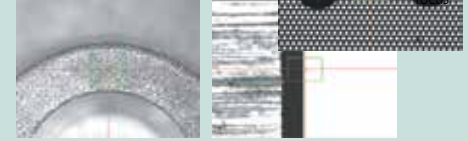

Surface focus

Edge focus

#### Programmable Ring Light (PRL)

Fine control of obliquity and direction provides illumination optimal for measurement. Obliquity can be arbitrarily set in the range from 30° to 80°. This type of illumination is effective for enhancing the edge of inclined surfaces or very small steps. Illumination can be controlled independently in every direction, back and forth, right and left. Measurement with edge enhancement is possible by forming a shadow with lighting from only one direction.

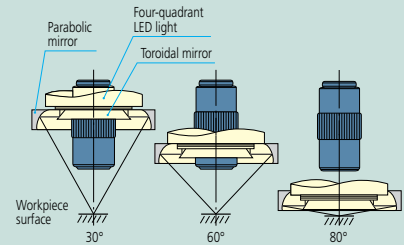

#### Tracking Auto Focus (TAF)

The TAF feature focuses continuously, adjusting to changes in the height of the object being measured. Automatic tracking of surface waves and warpage (in the Z axis) improves measurement throughput. The feature also removes the hassle of focusing during manual measurement.

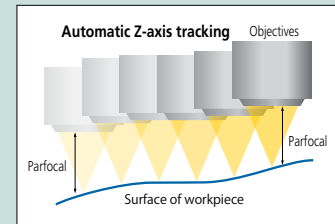

#### Tracking Auto Focus (TAF)

AF principle	Objective Coaxial Autofocusing (Knife-edge method)				
Suitable Objectives	QV-HR1x	QV-SL1x	QV-HR2.5x	QV-SL2.5x	QV-5x
Tracking Range*2	6.3mm (±3.15mm)	6.3mm (±3.15mm)	1mm (±0.5 mm)	1mm (±0.5 mm)	0.25mm (±0.125mm)
Spot Diameter*3	5.2µm	8.0µm	2.1µm	3.1µm	1.5µm
Laser Source	Semiconductor laser (peak wavelength: 690nm)				
Laser Power	0.9mW				
Laser Safety	Class 2 (JIS C6802:2011, EN/IEC 60825-1:2007)				

\*2 Varies according to workpiece surface texture and reflectance.

\*3 Design values.

# Quick Vision with Touch-Trigger Probe

## QV3DCAD-Online

QV3DCAD-Online uses 3D CAD models to easily create QVPAK part programs. QV measurements can be performed by specifying an element in the CAD data. This improves program creation efficiency more than using a joystick to perform teaching.

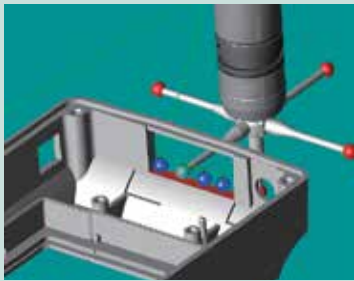
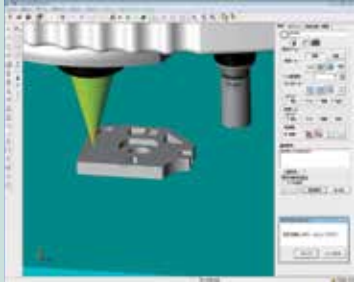

The interference check function can be used to prevent problems caused by the probe or objective lens colliding with the workpiece.

## Non-contact and contact measurement with one machine

QV touch probe allows both vision measurement and touch-probe measurement.

## 3D workpiece measurement

Measures three-dimensional workpieces such as molded products, resin-molded products, machined products and more.

## Module change rack available

Easily change between vision and touch-probe measurement with a module change rack.

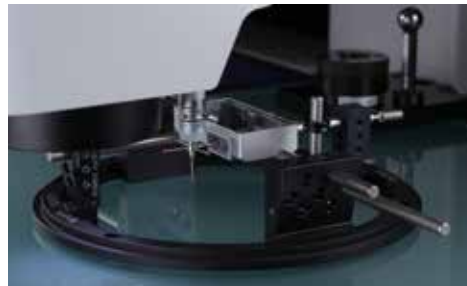
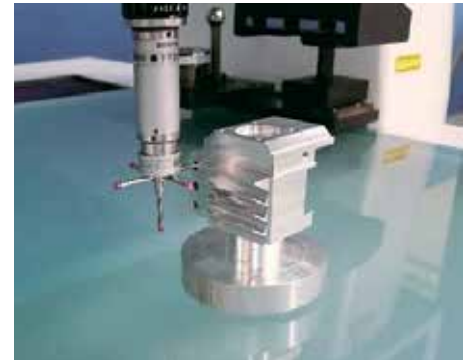
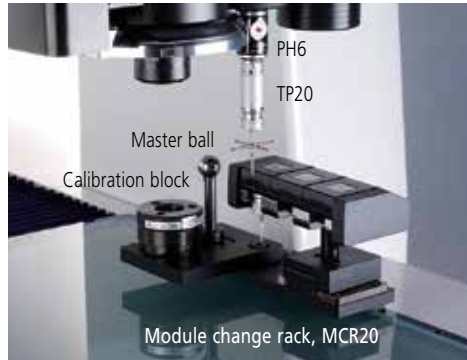

QV Active with optional Opti-fix clamping system

## Supported CAD Formats

- SAT
- IGES\*
- STEP\*
- Parasolid\*
- SolidWorks\*
- Unigraphics\*
- CATIA\*

\* optional

## Specifications with Touch-Probe Option

		QV TP Active 202	QV TP Active 404	QV TP Apex302 Hyper QV TP302	QV TP Apex404 Hyper QV TP404	QV TP Apex606 Hyper QV TP606
Measuring Range*1 (X×Y×Z)	Vision	250×200×150mm	400×400×200mm	300×200×200mm	400×400×250mm	600×650×250mm
	Touch Probe	131×200×150mm†	284×400×200mm	234×200×200mm	334×400×250mm	534×650×250mm
Measuring accuracy*2 (Touch Probe)	$E_{1X}, E_{1Y}, E_{1Z}$	(2.4+3L/1000)μm	(2.4 + 3L/1000)μm	QV TP Apex:(1.8+3L/1000)μm Hyper QV TP:(1.7+3L/1000)μm		

		QV TP ACCEL 808	QV TP ACCEL 1010	QV TP ACCEL 1212	QV TP ACCEL 1517
Measuring Range*1 (X×Y×Z)	Vision	800×800×150mm	1000×1000×150mm	1250×1250×100mm	1500×1750×100mm
	Touch Probe	734×800×150mm	934×1000×150mm	1184×1250×100mm	1434×1750×100mm
Measuring Accuracy*2 (Touch probe)	$E_{1X}, E_{1Y}, E_{1Z}$	(1.8+3L/1000)μm	(3+4L/1000)μm	(6+7L/1000)μm	

\*1: When a module change rack, a master ball and a calibration ring are mounted, the measurement ranges are smaller than those in the table. Other specifications are the same as those of QV ELF, QV Apex, Hyper QV, and QV ACCEL. Please contact our sales office for more details.

\*2: Inspected by Mitutoyo standard. L = length between two arbitrary points (mm)

† : With calibration ring removed.

# Accessories for Quick Vision

## Tracking Auto Focus (TAF)

The TAF feature focuses continuously, adjusting to changes in the height of the object being measured. Automatic tracking of surface waves and warpage (in the Z axis) improves measurement throughput. The feature eliminates the hassle of focusing during manual measurement.

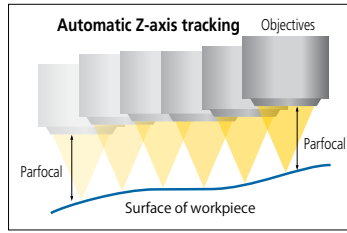

### Tracking Auto Focus (TAF)

AF principle	Objective Coaxial Autofocusing (Knife-edge Method)				
Suitable Objectives	QV-HR1x	QV-SL1x	QV-HR2.5x	QV-SL2.5x	QV-5x
Tracking Range*2	6.3mm (±3.15mm)	6.3mm (±3.15mm)	1mm (±0.5 mm)	1mm (±0.5 mm)	0.25mm (±0.125mm)
Spot Diameter*3	5.2µm	8.0µm	2.1µm	3.1µm	1.5µm
Laser Source	Semiconductor laser (peak wavelength: 690nm)				
Laser Power	0.9mW				
Laser Safety	Class 2 (JIS C6802:2011, EN/IEC 60825-1:2007)				

\*2 Varies according to workpiece surface texture and reflectance.  
\*3 Design values.

## PFF (Points from Focus)

Mitutoyo-developed optical data collection method that stitches images together with high-resolution Z axis data.

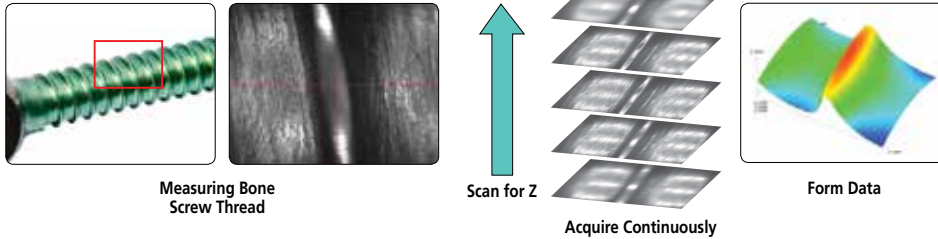

## Calibration Glass Chart

### No. 02AKN020 †

A calibration chart is used to compensate for the pixel size of the CCD chip, autofocus accuracy and the optical axis offset at each magnification of the variable magnification unit (PPT).



## Compensation Chart

### No. 02AKU400\*

A compensation chart is used to decrease optical distortion and errors caused by difference of the pattern and texture on the workpiece surface.



## QV-Index Head\*

Automatic multi-plane measurement is possible with the optional index table.

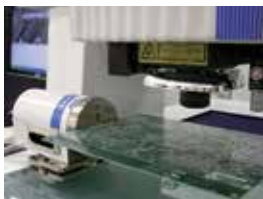

Max. workpiece diameter	5.51" / 140mm
Max. workpiece mass	4.41 lbs / 2kg
Min. rotation angle	0.1°
Positioning accuracy	±0.5°
Max. rotation speed	10rpm

## Capable of Supporting ISO10360-7 Guaranteed Accuracy

Some models in the Quick Vision Series support the ISO10360-7 guaranteed accuracy specifications.

Contact Mitutoyo for details on applicable models.

### Guaranteed accuracies

- Length measurement error  $E_{L^*/MPE}$
- Probing error  $P_{F2D^*/MPE}$

Length measurement error E

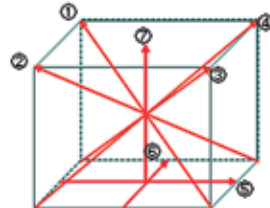

## Objectives



Objective mag.	Turret lens mag.	Monitor mag.	Field of View
0.5X	1X	16X	12.54 x 9.40
	2X	32X	6.27 x 4.70
	6X	96X	2.09 x 1.56
1X	1X	32X	6.27 x 4.70
	2X	64X	3.13 x 2.35
	6X	192X	1.04 x 0.78
2.5X	1X	80X	2.50 x 1.88
	2X	160X	1.25 x 0.94
	6X	480X	0.41 x 0.31
5X	1X	160X	1.25 x 0.94
	2X	320X	0.62 x 0.47
	6X	960X	0.20 x 0.15
10X	1X	320X	0.62 x 0.47
	2X	640X	0.31 x 0.23
	6X	1920X	0.10 x 0.07
25X	1X	800X	0.25 x 0.18
	2X	1600X	0.12 x 0.09
	6X	4800X	0.04 x 0.03

## Objective †

Objective	Order No.	Working Distance
QV-SL0.5X	<b>02AKT199</b>	30.5mm
QV-HR1X	<b>02AKT250</b>	40.6mm
QV-SL1X	<b>02ALA150</b>	52.5mm
QV-HR2.5X	<b>02AKT300</b>	40.6mm
QV-SL2.5X	<b>02ALA170</b>	60mm
QV-5XHR	<b>02AWD010</b>	20mm
QV-10XHR	<b>02AKT650</b>	20mm
QV-25X	<b>02ALG020</b>	13mm

The monitor magnification and field of view values are for the PRO machine.  
QV-10X, QV-25X: Depending on a workpiece of illumination may be insufficient at a turret lens magnification of 2X and 6X.  
QV-25X: The PRL illumination is restricted in its usable position.

## Multi-Function Control Box

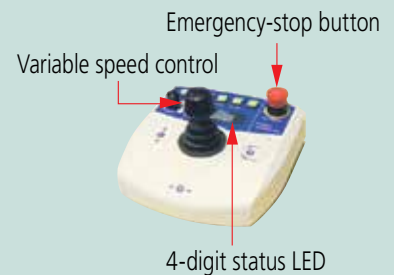

# OPTI-FIX Kits

## Modular Clamping System for Vision Measuring Systems

The modular opti-fix clamping system has been developed specifically for optical coordinate measuring systems.

Opti-fix guarantees safe part fixturing during measurement. This functional configuration also makes multiple part measurements considerably easier.

In order to reduce errant reflections of lighting systems and ambient light effects to a minimum, all important construction elements are anodized in flat-black or matte finish.

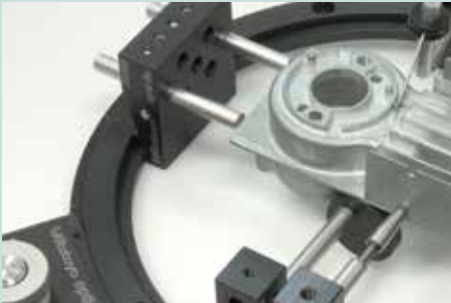

For mounting workpieces on the glass stage, different fixturing methods are available.

In the case of measuring methods using reflected, as well as transmitted light, for measurement of cubic, rotationally symmetrical and flat workpieces, the use of Opti-fix is a practical solution.

Furthermore, the spring clips and centering pins are integrated into the system to allow for tactile measuring. Opti-fix offers a large number of configurations for part fixturing, from clamping tweezers for miniature parts to a precision vice for large parts.

Fastening brackets, vacuum plates or magnetic holders for mounting the clamping system on the measuring machine, can be ordered separately.

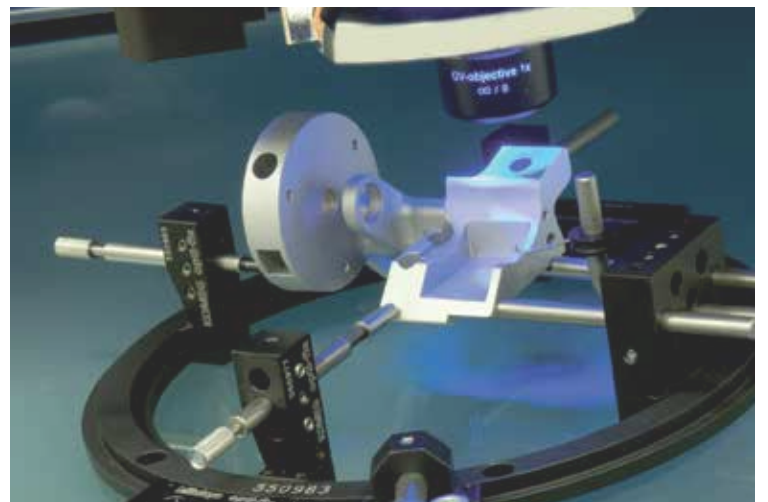
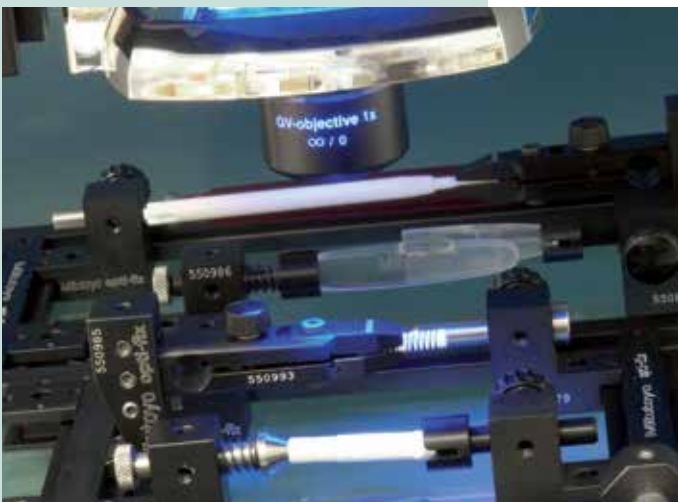
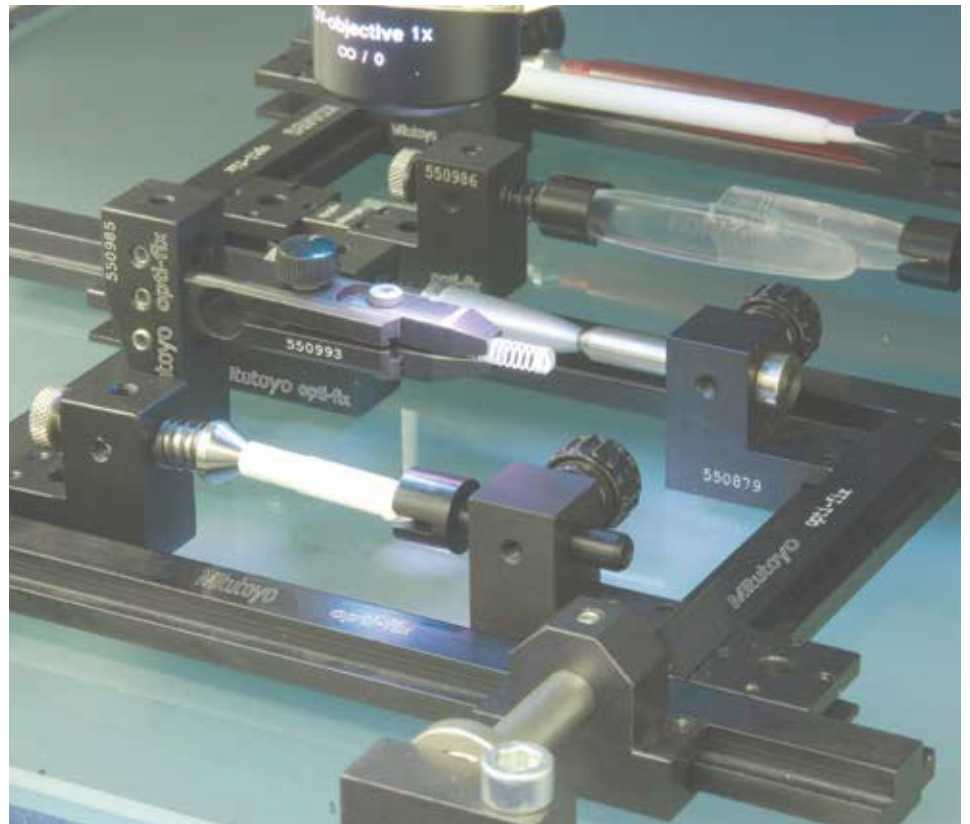

# OPTI-FIX Kits

## Opti-Set Start



K551056

For construction of a simple rail system with a length of 250 mm and for fixturing parts with simple part geometry. 16 parts.

## Opti-Set Basic



K551057

For construction of a basic frame with the dimensions of 200 mm x 100 mm and for fixturing parts with simple part geometry. 26 parts.

## Opti-Set Rotation



K551058

For construction of a basic frame with the dimensions of 250 mm x 200 mm and for fixturing parts that are rotationally symmetric with and without center holes. 23 parts.





# OPTI-FIX Kits

## Opti-Set Advanced



**K551059**

For construction of a basic frame with the dimensions of 400 mm x 250 mm and for fixturing parts with slightly more complex part geometry. 51 parts.

## Opti-Set Professional



**K551060**

For construction of a basic frame with the dimensions of 400 mm x 250 mm and for fixturing parts with complex part geometry. The fixturing of parts with a rotational part geometry is also available. 115 parts.

## Opti-Set Round

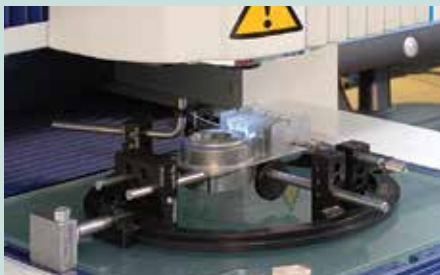

**K550298**

With locating and clamping elements, included adaptor plates for adaptation to the basic frame of the rail system. 18 parts.

# Quick Guide to Precision Measuring Instruments



## Vision Measuring Machines

### ■ Vision Measurement

Vision measuring machines provide the following processing capabilities.

#### ■ Edge detection

Detecting/measuring edges in the XY plane



#### ■ Auto focusing

Focusing and Z measurement



#### ■ Pattern recognition

Alignment, positioning, and checking the presence of a feature

### ■ Image Storage

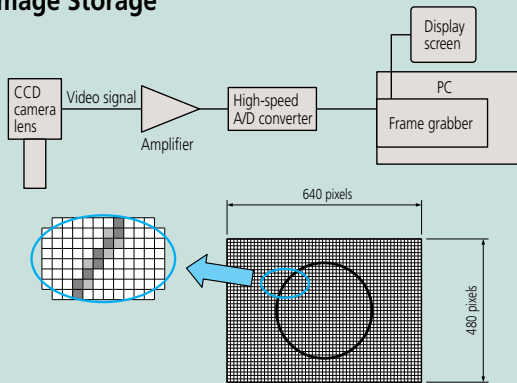

An image is comprised of a regular array of pixels, similar to the process that produces a printed image picture on fine plotting paper with each square solid-filled.

### ■ Gray Scale

A PC stores an image after internally converting it to numeric values. A numeric value is assigned to each pixel of an image. Image quality varies depending on how many levels of gray scale are defined by the numeric values. The PC provides two types of gray scale: two-level and multi-level. The pixels in an image are usually displayed as the 256-level gray scale.

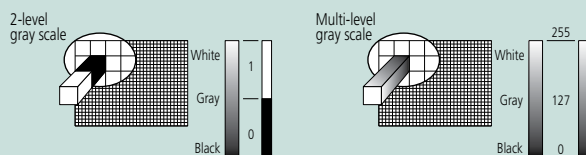

Pixels in an image brighter than a given level are displayed as white and all other pixels are displayed as black.

Each pixel is displayed as one of 256 levels between black and white. This allows high-fidelity images to be displayed.

### ■ Difference in Image Quality

Difference between 2-level and 256-level gray-scale images



Sample image displayed in 2-level gray scale

Sample image displayed in 256-level gray scale

### ■ Variation in Image Depending on Threshold Level



These three pictures are the same image displayed as 2-level gray scale at different slice levels (threshold levels). In a 2-level gray-scale image, different images are provided as shown above due to a difference in slice level. Therefore, the 2-level gray scale is not used for high-precision vision measurement since numeric values will change depending on the threshold level that is set.

### ■ Dimensional Measurement

An image consists of pixels. If the number of pixels in a section to be measured is counted and multiplied by the size of a pixel, then the section can be converted to a numeric value in length. For example, assume that the total number of pixels in the lateral size of a square workpiece is 300 pixels as shown in the figure below. If a pixel size is  $10\mu\text{m}$  under a specific imaging magnification, the total length of the workpiece is given by  $10\mu\text{m} \times 300 \text{ pixels} = 3000\mu\text{m} = 3\text{mm}$ .

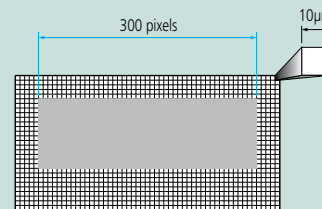

### ■ Edge Detection

How to detect a workpiece edge in an image is described using the following monochrome picture as an example. Edge detection is performed within a given domain. A symbol that visually defines this domain is referred to as a tool. Multiple tools are provided to suit various workpiece geometries or measurement data.

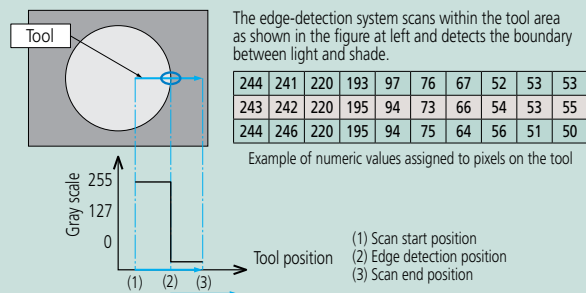

## High-resolution Measurement

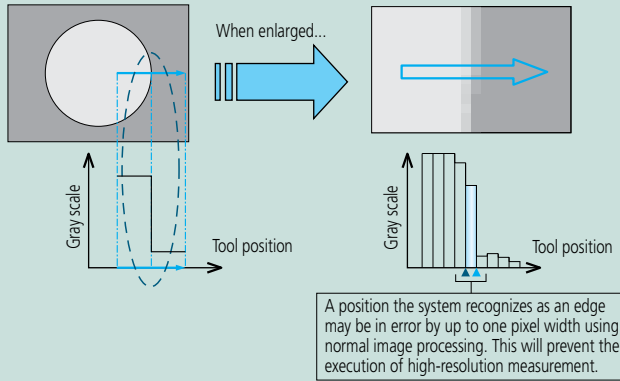

To increase the accuracy in edge detection, sub-pixel image processing is used.

An edge is detected by determining an interpolation curve from adjacent pixel data as shown below.

As a result, it allows measurement with a resolution higher than 1 pixel.

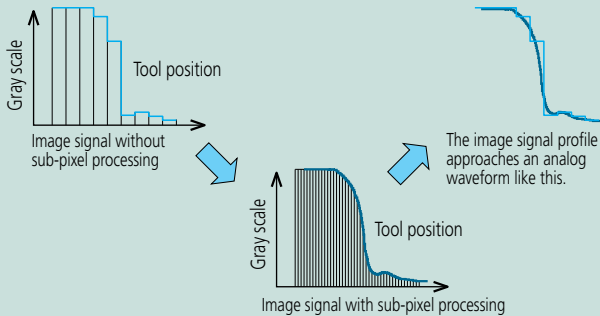

## Measurement along Multiple Portions of an Image

Large features that cannot be contained on one screen have to be measured by precisely controlling the position of the CCD sensor and stage so as to locate each reference point within individual images. By this means, the system can measure even a large circle, as shown below, by detecting the edge while moving the stage across various parts of the periphery.

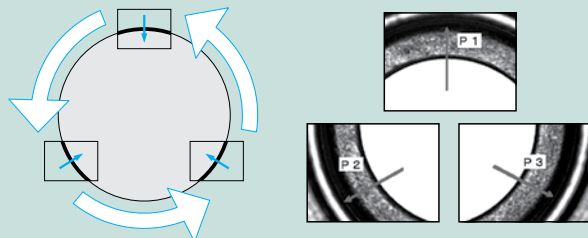

## Composite Coordinates of a Point

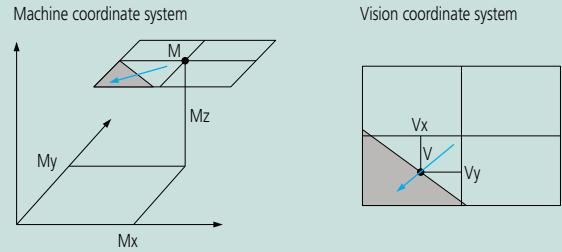

Measuring machine stage position  
 $M = (M_x, M_y, M_z)$

Detected edge position (from the center of vision)  
 $V = (V_x, V_y)$

Actual coordinates are given by  $X = (M_x + V_x)$ ,  $Y = (M_y + V_y)$ , and  $Z = M_z$ , respectively.

Since measurement is performed while individual measured positions are stored, the system can measure dimensions that cannot be included in one screen.

## Principle of Auto Focusing

The system can perform XY-plane measurement, but cannot perform height measurement using only the CCD camera image. The system is commonly provided with the Auto Focus (AF) mechanism for height measurement. The following explains the AF mechanism that uses a common image, although some systems may use an AF laser.

The AF system analyzes an image while moving the CCD in the Z axis. In the analysis of image contrast, an image in sharp focus will show a peak contrast and one out of focus will show a low contrast. Therefore, the height at which the image contrast peaks is the just-in-focus height.

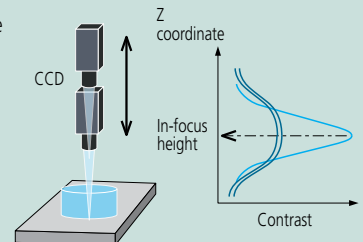

## Variation in Contrast Depending on the Focus Condition

Edge contrast is low due to out-of-focus edges.

Edge contrast is high due to sharp, in-focus edges.

