



Digimatic Scale Units



Linear Scales



2D Image Correlation Encoder



AT1100

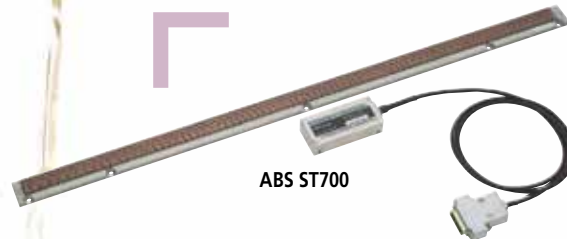

ABS ST700



MICSYS-SA1



ST-F11
Fiber Scale

INDEX

Digimatic Scale Units

SD ABSOLUTE Digimatic Scale Units	H-2,3
ABSOLUTE Digimatic Scale Units	H-4,5
Quill Kit with Absolute Encoder	H-6
KA-200 Counter	H-7
KLD200 Counter	H-7

Linear Scales

Linear Scale Counter	H-8
Digital Readout/ DRO packages 2-Axis/3-Axis Travels	H-9
Linear Scales System Diagram	H-10,11
Linear Scales ABS AT1100	H-12
Linear Scales ABS AT300	H-13
Linear Scales ABS AT715	H-14
Linear Scales ABS AT500	H-15
Linear Scales ABS ST700	H-16
Linear Scales ABS ST1300	H-17
MICSYS	H-18
Linear Scales AT103	H-19
Linear Scales AT113	H-20
Linear Scales AT112-F	H-21
Linear Scales AT116	H-22
Linear Scales AT402E	H-23
Linear Scales AT203	H-24
Linear Scales AT216-T / AT217-TL	H-25
AT211-A (Multipoint mounting), AT211-B (Double-end mounting)	H-26
Linear Scales ST422	H-27
Linear Scales ST46-EZA	H-28
Linear Scales ST36	H-29
Fiber Scale ST-F11	H-30,31
Pulse Signal Interface Unit PSU-200	H-32
Signal Conversion Adapter PSU-400E	H-33
Quick Guide to Precision Measuring Instruments - Linear Scales	H-34,35



ABS AT500-S



ABS AT500-H

SD ABSOLUTE Digimatic Scale Units

SERIES 572

ABSOLUTE™



IP66

Horizontal single-function type (Water-proof type)
572-602 SD-20G



Horizontal single-function type
572-202-20 SD-20DX



Horizontal multi-function type
572-461 SD-15E



Vertical single-function type
572-303-10 SDV-30D



Vertical multi-function type
572-561 SDV-15E

- SD series facilitates mounting on jigs, tools and small machine tools to enable accurate positioning.
- Built-in absolute scale including the ABS point requires no zero-set every time the power is turned on. In addition, reliability has improved thanks to elimination of overspeed errors.
- Horizontal or vertical display according to the scale mounting direction.
- The dust resistance and the environmental resistance of the display has improved. The **SD-G** series offers dust/water protection level IP66.
- Long battery life for easier maintenance.
- **EC** counters are available as external display units.
- Equipped with an output port to transfer measurement data. This allows implementation in control systems and gaging systems.

Applications

Machine table position

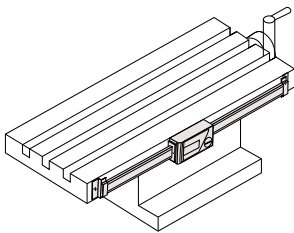

Drilling machine stroke position

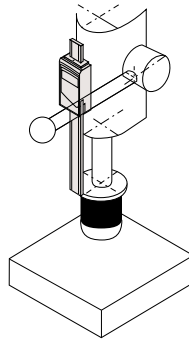

Focus setting on optical instruments

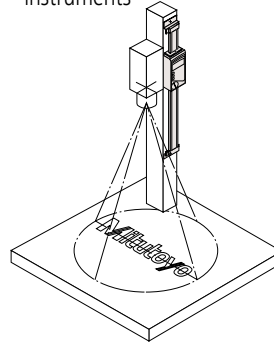

Special applications

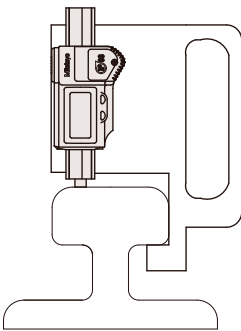

As a measurement jig for outdoor use (SD-G)

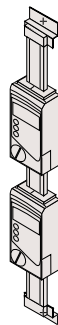

Detector head mechanism

Functions

- **ABS** (Absolute) measurement function
 - **INC** (Incremental) measurement function
 - Zero-setting function
 - Presetting function (2 preset values can be set. Not available for **SD-G, SD-D, SDV-D**)
 - Double reading function (Available only for **SD-F** or **SDV-F**)
 - Direction switch function
Not available for **SD-G, SD-D, SDV-D, SD-F, SDV-F**
 - Hold function*
 - Measurement value composition error alarm
 - Low-battery alarm
 - Output function
- * To activate the hold function when using **SD-D** or **SDV-D**, an optional hold unit is required. Simultaneous activation with the output function is not available. **SD-G** are also available to special order.
- * These units use 1.5V silver oxide cells for the power supply. Therefore, when the units are directly fixed to the frame of a machine tool that requires a high voltage, malfunction such as display digit fluctuations and errors may occur. The countermeasure examples are described in the user manuals provided.

Please contact Mitutoyo for other special orders.

System Diagram

[Scale units]

Single-function type with high dust/water resistance



Single-function type



Multi-function type



Multi-function type (double reading)



[Display units]



Tolerance judgment output*1

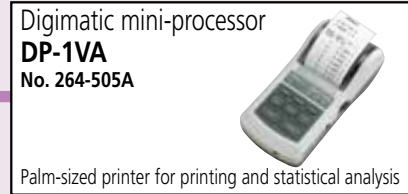

RS-232C/USB output

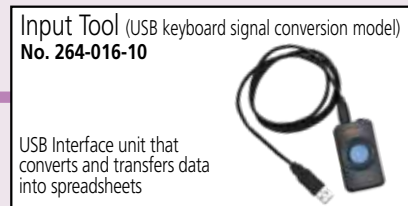

USB keyboard signal conversion

* Connection to an RS-232C conversion type (IT-007R) or a PS/2 keyboard signal conversion type (IT-005D) input tool is also available.

Connecting cable with the water-proof type output switch*2 40"/1m : No.05CZA624
80"/2m : No.05CZA625

Connecting cable with the output switch 1m : No.959149
2m : No.959150

Connecting cable with the output switch



① 40"/1m : No.905338
80"/2m : No.905409

② 40"/1m : No.905689
80"/2m : No.905690

③ 40"/1m : No.905691
80"/2m : No.905692

④ 40"/1m : No.905693
80"/2m : No.905694

Connecting cable 40"/1m : No.936937
80"/2m : No.965014

- * 1: Select the tolerance judgment output or digimatic output when setting the parameters.
- * 2: Connecting cable with the water-proof type output switch can be used only for **SD-G** or Water-proof Digital Caliper **CD-15/20/30PM** equipped with external output function.
- * 3: Connecting of **SD** series and **DP-1VR/MIG-UUSB/IT-012U** is also available without passing through the EC counter.
In this case, connect these units and **SD** series with the cables used for the connection with the **EC** counter.

ABSOLUTE Digimatic Scale Units

SERIES 572

SPECIFICATIONS

Type	Unit spec.	Order No.	Model	Range	Resolution	Accuracy	Repeatability	Battery life
Horizontal single-function type (Water-proof type)	Metric	572-600	SD-10G	0-100mm	0.01mm	0.03mm	.0005" / 0.01mm	Approx. 13000 hours
		572-601	SD-15G	0-150mm				
		572-602	SD-20G	0-200mm				
	Inch/Metric	572-613	SD-4"/10G	0-4"/0-100mm	0.0005"/0.01mm	0.03mm/.001"		
		572-614	SD-6"/15G	0-6"/0-150mm				
Horizontal single-function type	Metric	572-200-20	SD-10DX	0-100mm	0.01mm	0.03mm	Approx. 20000 hours	
		572-201-20	SD-15DX	0-150mm		0.04mm		
		572-202-20	SD-20DX	0-200mm				
		572-203-10	SD-30D	0-300mm				
	Inch/Metric	572-210-20	SD-4"DX	0-4"/0-100mm	0.0005"/0.01mm	0.03mm/.001"		
		572-211-20	SD-6"DX	0-6"/0-150mm		0.04mm/.002"		
		572-212-20	SD-8"DX	0-8"/0-200mm				
Horizontal multi-function type	Metric	572-213-10	SD-12"D	0-12"/0-300mm	0.01mm	0.03mm	Approx. 5000 hours	
		572-460	SD-10E	0-100mm		0.04mm		
		572-461	SD-15E	0-150mm				
		572-462	SD-20E	0-200mm				
		572-463	SD-30E	0-300mm				
		572-464	SD-45E	0-450mm				
		572-465	SD-60E	0-600mm				
	572-466	SD-80E	0-800mm	0.05mm				
	Inch/Metric	572-467	SD-100E	0-1000mm	0.0005"/0.01mm	0.06mm		
		572-470	SD-4"E	0-4"/0-100mm		0.07mm		
		572-471	SD-6"E	0-6"/0-150mm				
		572-472	SD-8"E	0-8"/0-200mm				
		572-473	SD-12"E	0-12"/0-300mm				
		572-474	SD-18"E	0-18"/0-450mm				
		572-475	SD-24"E	0-24"/0-600mm				
		572-476	SD-32"E	0-32"/0-800mm				
		572-477	SD-40"E	0-40"/0-1000mm				
572-480-10		SD-10F	0-100mm	0.0005" / 0.01mm			Approx. 5000 hours	
Metric	572-481-10	SD-15F	0-150mm		0.01mm			0.03mm
	572-482-10	SD-20F	0-200mm					
	572-483-10	SD-30F	0-300mm					
	572-484-10	SD-45F	0-450mm					
	572-485-10	SD-60F	0-600mm					
	572-486-10	SD-80F	0-800mm					
	572-487-10	SD-100F	0-1000mm					
Inch/Metric	572-490-10	SD-4"F	0-4"/0-100mm		0.0005"/0.01mm	0.04mm		
	572-491-10	SD-6"F	0-6"/0-150mm					
	572-492-10	SD-8"F	0-8"/0-200mm					
	572-493-10	SD-12"F	0-12"/0-300mm					
	572-494-10	SD-18"F	0-18"/0-450mm					
	572-495-10	SD-24"F	0-24"/0-600mm					
	572-496-10	SD-32"F	0-32"/0-800mm					
	572-497-10	SD-40"F	0-40"/0-1000mm					
	572-300-10	SDV-10D	0-100mm			0.01mm		0.03mm
	Metric	572-301-10	SDV-15D	0-150mm				
572-302-10		SDV-20D	0-200mm					
572-303-10		SDV-30D	0-300mm					
Inch/Metric	572-310-10	SD-4"D	0-4"/0-100mm	0.0005"/0.01mm	0.04mm			
	572-311-10	SD-6"D	0-6"/0-150mm					
	572-312-10	SD-8"D	0-8"/0-200mm					
	572-313-10	SD-12"D	0-12"/0-300mm					
	572-560	SDV-10E	0-100mm		0.01mm	0.03mm	Approx. 5000 hours	
Metric	572-561	SDV-15E	0-150mm					
	572-562	SDV-20E	0-200mm					
	572-563	SDV-30E	0-300mm					
	572-564	SDV-45E	0-450mm					
	572-565	SDV-60E	0-600mm					
	572-566	SDV-80E	0-800mm					
572-567	SDV-100E	0-1000mm						
Inch/Metric	572-570	SDV-4"E	0-4"/0-100mm	0.0005"/0.01mm	.001"/0.03mm			
	572-571	SDV-6"E	0-6"/0-150mm					
	572-572	SDV-8"E	0-8"/0-200mm					
	572-573	SDV-12"E	0-12"/0-300mm					
	572-574	SDV-18"E	0-18"/0-450mm					
	572-575	SDV-24"E	0-24"/0-600mm					
	572-576	SDV-32"E	0-32"/0-800mm					
	572-577	SDV-40"E	0-40"/0-1000mm					
	572-580-10	SDV-10F	0-100mm		0.01mm	0.03mm	Approx. 5000 hours	
Metric	572-581-10	SDV-15F	0-150mm					
	572-582-10	SDV-20F	0-200mm					
	572-583-10	SDV-30F	0-300mm					
	572-584-10	SDV-45F	0-450mm					
	572-585-10	SDV-60F	0-600mm					
	572-586-10	SDV-80F	0-800mm					
	572-587-10	SDV-100F	0-1000mm					
Inch/Metric	572-590-10	SDV-4"F	0-4"/0-100mm	0.0005"/0.01mm				.001"/0.03mm
	572-591-10	SDV-6"F	0-6"/0-150mm					
	572-592-10	SDV-8"F	0-8"/0-200mm					
	572-593-10	SDV-12"F	0-12"/0-300mm					
	572-594-10	SDV-18"F	0-18"/0-450mm					
	572-595-10	SDV-24"F	0-24"/0-600mm					
	572-596-10	SDV-32"F	0-32"/0-800mm					
	572-597-10	SDV-40"F	0-40"/0-1000mm					

Note: Response speed is unlimited

DIMENSIONS

Unit: mm

Type

Horizontal type example



SD-G

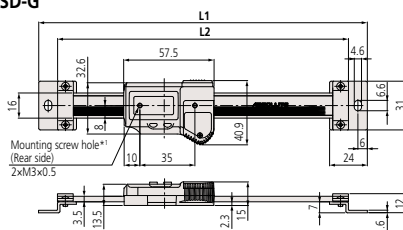

SD-D

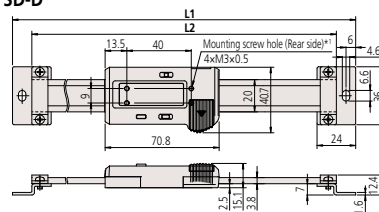

SD-E (to 300mm) / SD-F (to 300mm)

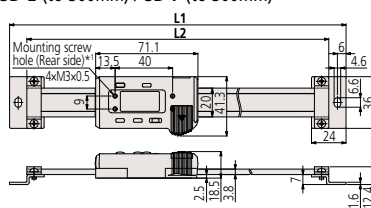

SDV-E (to 300mm) / SDV-F (to 300mm)

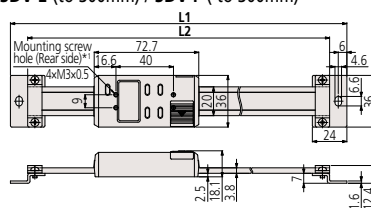

SD-DX

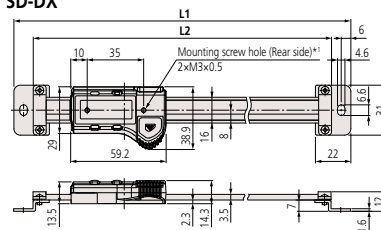

SDV-D

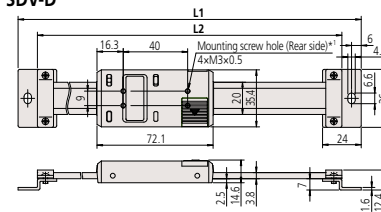

SD-E (450 to 1000mm) / SD-F (450 to 1000mm)

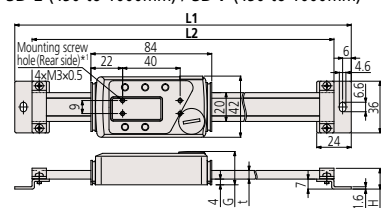

SDV-E (450 to 1000mm) / SDV-F (450 to 1000mm)

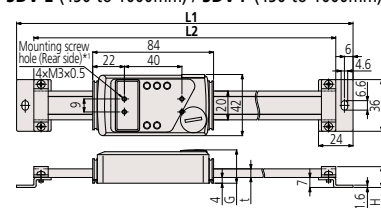

*1: Inch/Metric models have 5-40 UNC threaded rear holes. Refer to the dimension table for details of the depth including the screw on the rear of the display.

Vertical type example



SPECIFICATIONS

Model	Range (mm)	Dimensions(mm)					Depth including the screw on the rear of the display	Mass (g)	
		L1	L2	t	G	H			
SD-G	100	209	185	—	—	—	Less than 2mm	390	
	150	259	235	—	—	—		410	
	200	311	287	—	—	—		430	
SD-DX	100	209	185	—	—	—	Less than 2mm	230	
	150	259	235	—	—	—		250	
	200	311	287	—	—	—		270	
SD-30D	300	444	420	—	—	—	Less than 2mm	370	
SD-E SD-F	100	244	220	—	—	—		250	
	150	294	270	—	—	—		280	
	200	344	320	—	—	—	310		
	300	444	420	—	—	—	370		
	450	594	570	6	23.2	14.6	Less than 3mm	760	
600	774	750	—	—	—	900			
800	974	950	10	27.2	18.6	1710			
SDV-D	100	244	220	—	—	—	Less than 2mm	2040	
	100	244	220	—	—	—		250	
	150	294	270	—	—	—		280	
	200	344	320	—	—	—		310	
	300	444	420	—	—	—		370	
SDV-E SDV-F	100	244	220	—	—	—	Less than 2mm	250	
	150	294	270	—	—	—		280	
	200	344	320	—	—	—		310	
	300	444	420	—	—	—		370	
	450	594	570	6	23.2	14.6		Less than 3mm	760
	600	774	750	—	—	—			900
	800	974	950	10	27.2	18.6			1710
1000	1174	1150	—	—	—	2040			

Quill Kit with ABSOLUTE Encoder

Easy Installation Fits Most Vertical Knee Mills

FEATURES

- Easy to read LCD with resolution of .0005"/0.01mm. 0 -5" travel inch/mm
- Push button controls for inch/mm, zero-set and on/off.
- Powered by a single SR-44 battery which lasts about 1 year with normal use.
- SPC Output for data transmission to data processors or a remote display.

SPECIFICATIONS

Order No.	Description
053906B	Digimatic Quill Kit complete with brackets & scale for Bridgeport-type machines.

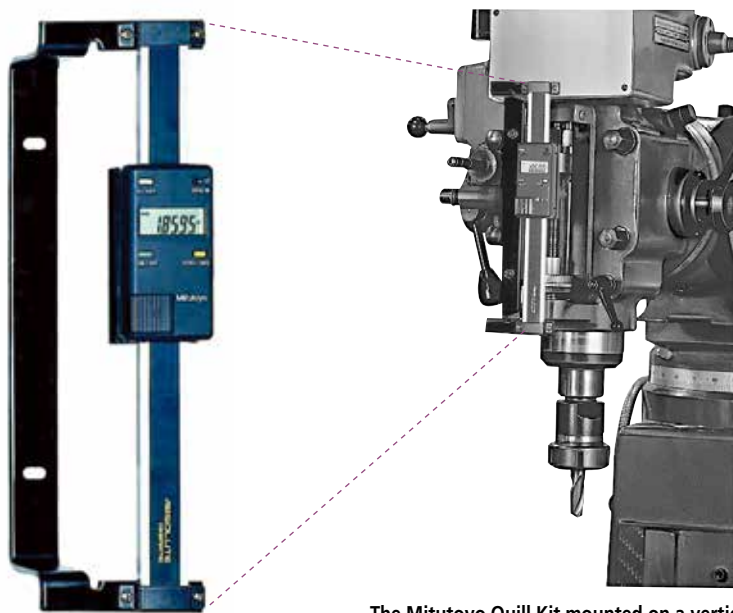

The Mitutoyo Quill Kit mounted on a vertical mill.

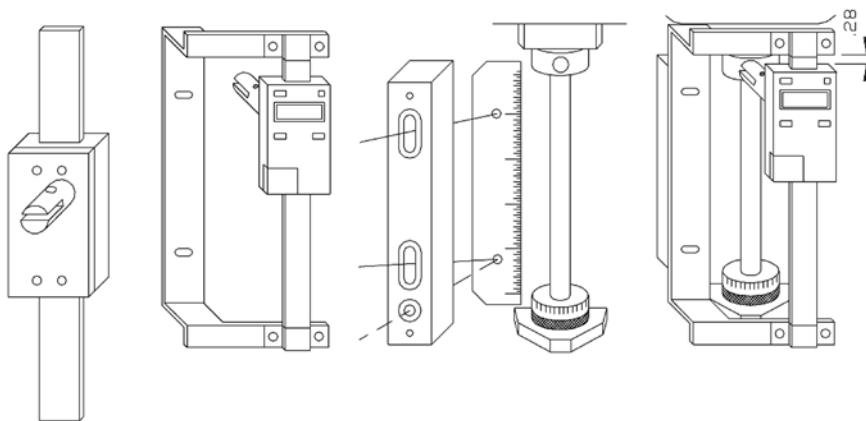

Optional Accessories

- 905338: SPC cable (40" / 1m standard)
- 905409: SPC cable (80" / 2m standard)
- 264-504-5A: DP-1VR data processor, 120V AC
- 02AZD810D: U-Wave-R (wireless receiver)
- 02AZD730D: U-Wave-T/IP67 type (wireless transmitter)
- 02AZD790F: U-Wave connecting cable F
- 02AZE200: U-Wave-T installation brackets kit

KA-200 Counter

SERIES 174 — Standard Type

- High performance, low cost 2 & 3 axis counter
- Absolute and incremental modes (10 presets each)
- Non-linear and linear error compensation
- Adjustable high-brightness, high-refresh rate LED displays
- Calculator function
- Outputs data into spreadsheets (optional USB card)



174-183A

DIMENSIONS

Unit: mm

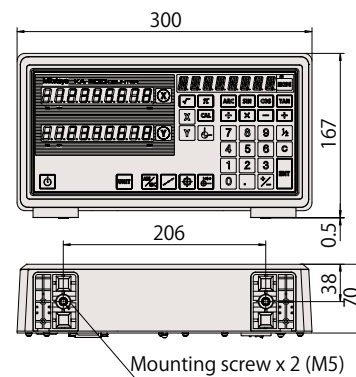

Optional Accessories

- 06AET993** Code out unit - USB output, RS232C output, Digimatic Input
- 06ACB393** Adapter for Linear gages with origin
- 06ACB913** Adapter for Linear gages without origin
- 06ACB391** Adapter for AT211 Linear Scales
- 06ACB392** Adapter for ST Series
- 09CAB231** Adapter for micrometer head
- 09AAA207** Adapter for previous model 6 pin linear scales
- 937179T** Foot switch to trigger USB output (06AET993 needed)
- 64AAB336** Foot switch to trigger RS-232C output (06AET993 needed)
- 06ACF941** Extension cable for remote load & zero (06AET993 needed)
- 965004** Foot switch to trigger RS-232C output (for 06ACF941 only)
- 937328** External load box (06AET993 & 06ACF941 needed)
- 936553** External zero box (06AET993 & 06ACF941 needed)
- 09EAA094** Counter cable RS232C for DP-1VR
- 64AAB519** RS232C output cable 6-ft. (25-9 pin)

SPECIFICATIONS

Order No.	174-183A	174-185A
Model	2-axis KA-212 Counter	3-axis KA-213 Counter
Resolution	With AT100 Series: 0.05 - 0.0001 mm, .02" - .000005" With AT715: 0.01 - 0.0005 mm, .02" - .000020"	
Scale input ports	2 or 3*	
Display type / digit	7-segment, 8-digit + sign + 8-character alphabet LED display, 14.2mm character height	
Output (optional)	RS-232C / USB	
Macro functions	Rectangular drilling and round milling newly added	
Main features	Feed speed display; taper machining function; tool data; multi-point compensation; scale check function; calculation function	
Dimensions	Size (WxDxH) 30x168x70mm	

*2nd and 3rd axis display can be disabled

Standard Accessories

- Power cable
- Ground lead
- Dust cover
- Alternate button labels for lathe mode
- Connector cap (Dsub-15)
- User's manual
- Warranty card

- Counter designed to signal when a linear scale displacement value and a preset limit value coincide.
- Two types of limit settings are available: 2-step (**KLD-212**) and 4-step (**KLD-214**).

KLD200 Counter

SERIES 174 — Special Purpose Type with Limit Signal Output



174-147A
KLD-214

SPECIFICATIONS

Order No.	174-146A	174-147A
Model	KLD-212	KLD-214
Number of axes to be displayed	1 axis	
Number of limit values to be set	2	4
Resolution	(Changeable according to the parameter) When AT100 series is connected: 0.05 to 0.0001mm When AT715 is connected: 0.01 to 0.001mm	
Output	RS-232C (provided as standard)	
Display	7-segment LCD / 7 digit*1	
Power supply voltage	120V AC, 60Hz	
Power consumption	25 VA	
Operating temperature/humidity range	0 to 45°C / 20 to 80%	
Dimensions	13.1"(W)x6.42"(D)x8.1"(H) / 332 (W)x163 (D)x204 (H) mm	
Mass	6.62 lb. / 3.0kg	6.84 lb. / 3.1kg

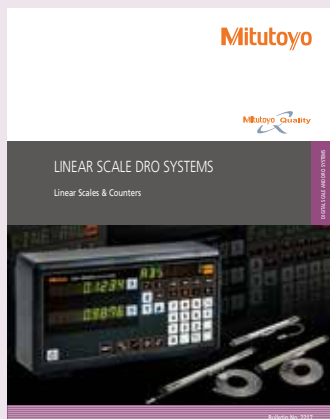

*1: Count range when the minimum reading is 0.001mm: 99999.999 to -9999.999
Count range when the minimum reading is 0.005mm: 99999.995 to -9999.995



Refer to Bulletin No. (2217) for more details.

Linear Scale Counter

FUNCTIONS

Function	Counter	KA-200 Counter	KLD-200 Counter
			
Zero-setting	ZERO	●	●
Preset	P.SET	●	●
Resolution setting	0.0008 / 0.001	●	●
Measurement direction setting	← / →	●	●
mm/inch conversion	mm / in	●	●
Diameter display	DIA	●	●
Scale reference point setting ¹	▼ Scr	●	●
1/2 calculation	1/2	●	●
Coordinate system switching	X / Y	●	—
Bolt-hole circle machining	⊕	● ²	—
Pitch machining	↔	●	—
Zero approach machining (INC mode)	⊕	●	—
Addition of 2-scale data	Z1+Z2	● ³	—
Linearity error compensation	↕	●	●
Pitch error compensation	↕	● ¹	—
Smoothing	1234	●	●
Memory backup	🔋	●	●
Expansion/contraction coefficient setting	↔	—	●
Lower digit blanking out	123 000	●	●
External zero-setting	ZERO SET INPUT	▲ ⁴	●
RS-232C interface unit	RS-232C OUTPUT	▲ ⁴	●
USB output	USB	▲ ⁵	—
Limit signal output	LIMIT OUTPUT	—	●
Error message	Error	●	●

● Standard function, ▲: Optional function, —: Not available
 -1: Only available when connecting with AT100 series.
 -2: Not available in single-axis use

-3: Only available for 3-axis model
 -4: Code out unit (06AET993) is required.
 -5: Text can be output by interface unit and foot switch

Adapter Cross Reference

(For adapting old linear scales to new counters, or new linear scales to old counters)

	Linear Scale Series No's.	Adapter No.	Counters
Old linear scales with 6 pin round connectors	FOR AT2-N, AT2, AT-11N, AT11, AT12N (529 Series)	09AAA207	All KA, KS, KC, UDR Series Counters with 15 pin connectors. (All 174 Series)
New linear scales w/15 pin D-Sub connectors	FOR AT102, AT103, AT111, AT112, AT113, AT115, AT116, AT181	09AAA181	For all .0001" resolution counters with seven pin round connectors
		09AAA181V*	APL Counter 164-660*, 164-661*, 164-662* MPK-2L 983-352
		09AAA198	For all .0005" resolution counters with six pin round connectors
		09AAA198V*	APL Counter 164-660*, 164-661*, 164-662*, 164-563*, 164-664*, 164-665* PL and PL Zero Output Counter 164-252A, 164-254A, 164-295A

* V = Vertical type

When only replacing one linear scale, you can use either horizontal or vertical type adapter.

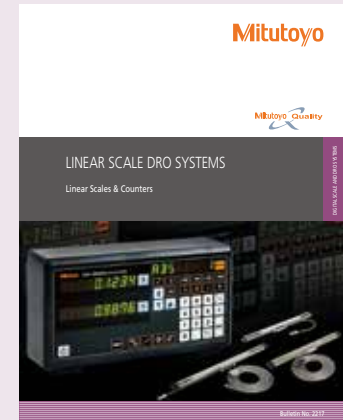

Refer to Bulletin No. (2217) for more details.



09AAA207



09AAA198

Digital Readout/DRO packages 2-Axis/3-Axis Travels

For Milling, Lathes & Surface Grinding Systems

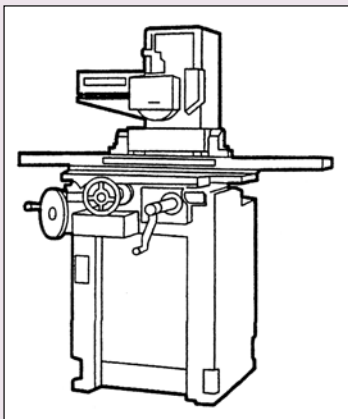
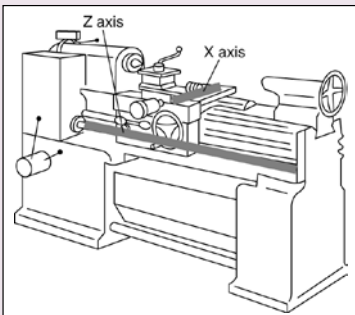
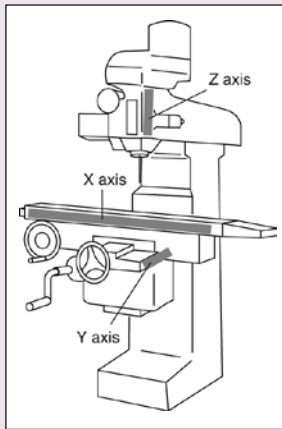

2-Axis, KA Counter Milling System

Package includes:

- KA-200 counter
- AT715 electromagnetic absolute linear scales
- Brackets for linear scales
- Display arm kit



X Axis Travel (AT715 Slim Electromagnetic)	Y Axis Travel (AT715 Slim Electromagnetic)			
	12" (539-805)	14" (539-806)	16" (539-807)	18" (539-808)
30" (539-814)	64PKA058A	64PKA060A	-	-
36" (539-816)	64PKA059A	-	64PKA062A	-
40" (539-817)	-	64PKA061A	64PKA063A	64PKA064A

3-Axis Milling Package (Z Axis: 6" Travel AT715)

Order No.	Description
64PKA065A	MILL pkg, 3-axis, ABS Scales, 12" x 30" x 6", w/3 axis KA Counter (174-185A)
64PKA066A	MILL pkg, 3-axis, ABS Scales, 12" x 36" x 6", w/3 axis KA Counter (174-185A)
64PKA067A	MILL pkg, 3-axis, ABS Scales, 16" x 36" x 6", w/3 axis KA Counter (174-185A)

2-Axis Lathe Package

Package includes:

- KA-200 counter
- AT116 and AT715 linear scale combinations (with cables)
- Mounting bracket kit
- Counter tray
- Additional extension cable (2m) included in 60" and 72" packages

Z-axis travel	X Axis Travel (AT116 Slim Glass Scale)					
	6"(539-272-30)	8"(539-273-30)	10"(539-274-30)	12"(539-275-30)	14"(539-276-30)	16"(539-277-30)
28" (539-813)	64PKA035A	-	-	-	-	-
30" (539-814)	64PKA036A	-	-	-	-	-
36" (539-816)	64PKA037A	-	-	-	-	-
40" (539-817)	64PKA038A	64PKA039A	64PKA042A	64PKA046A	64PKA052A	-
44" (539-818)	-	64PKA040A	64PKA043A	64PKA047A	64PKA053A	-
48" (539-819)	-	64PKA041A	64PKA044A	64PKA048A	64PKA054A	-
52" (539-820)	-	-	-	64PKA049A	64PKA055A	-
60" (539-822)	-	-	64PKA045A	64PKA050A	64PKA056A	64PKA057A
72" (539-825)	-	-	-	64PKA051A	-	-

2-Axis, KA Counter Grinder System

Package includes:

- KA-200 counter
- AT116 glass linear scales
- Mounting bracket kit
- Display arm kit

Vertical	Cross Side (AT116 Slim Glass Scale)			
	6" (539-272-30)	8" (539-273-30)	10" (539-274-30)	12" (539-275-30)
12" (539-275-30)	64PKA026A	64PKA028A	-	-
14" (539-276-30)	64PKA027A	64PKA029A	-	-
16" (539-277-30)	-	64PKA030A	-	-
18" (539-278-30)	-	-	64PKA031A	64PKA033A
20" (539-279-30)	-	-	-	64PKA034A
24" (539-281-30)	-	-	64PKA032A	-

Linear Scales

Linear Scale System Diagram

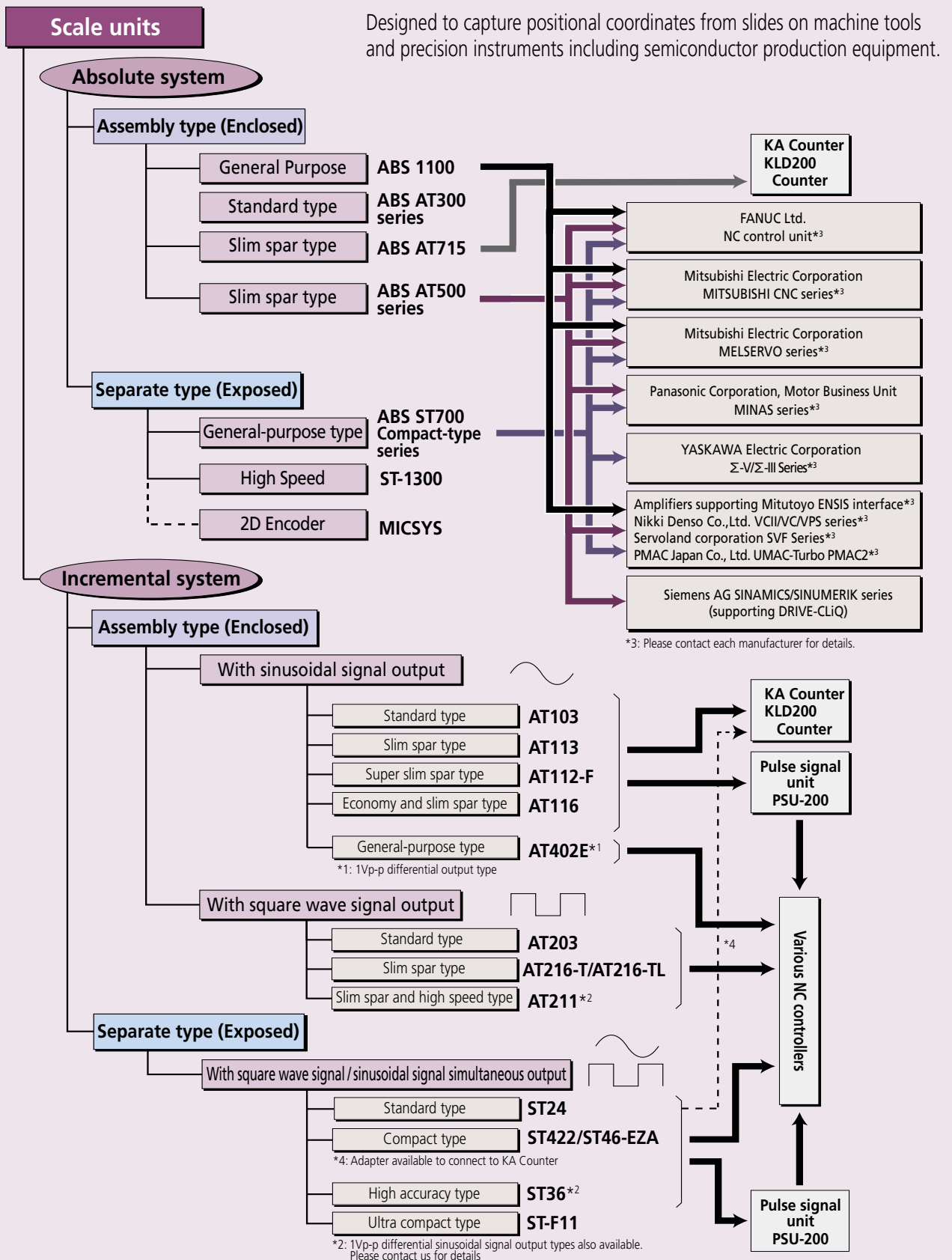

Name	Type	Page
AT1100	General-purpose Spar	H-12
AT300	Standard Spar	H-13
AT-715	Slim Spar (IP67)	H-14
AT500	Slim Spar	H-15
ABS ST700	General Purpose Compact type (Exposed)	H-16
ST1300	High Seep High Accuracy (Exposed)	H-17
MICSYS	2D Image Encoder (Exposed)	H-18
AT103	Standard	H-19
AT113	Slim Spar type	H-20
AT112-F	Super Slim part type	H-21
AT116	Economy and Slim Spar	H-22
AT402E	General-purpose	H-23
AT203	Standard type	H-24
AT216T/AT217-TL	Slim Spar	H-25
AT211	Slim spar type high speed	H-26
ST24	Standard Type (Exposed)	H-27
ST422/ST46-EZA	Compact type (Exposed)	H-28-29
ST36	High Accuracy type (Exposed)	H-30
ST-F11	Ultra Compact-Fiber scale (Exposed)	H-31-32

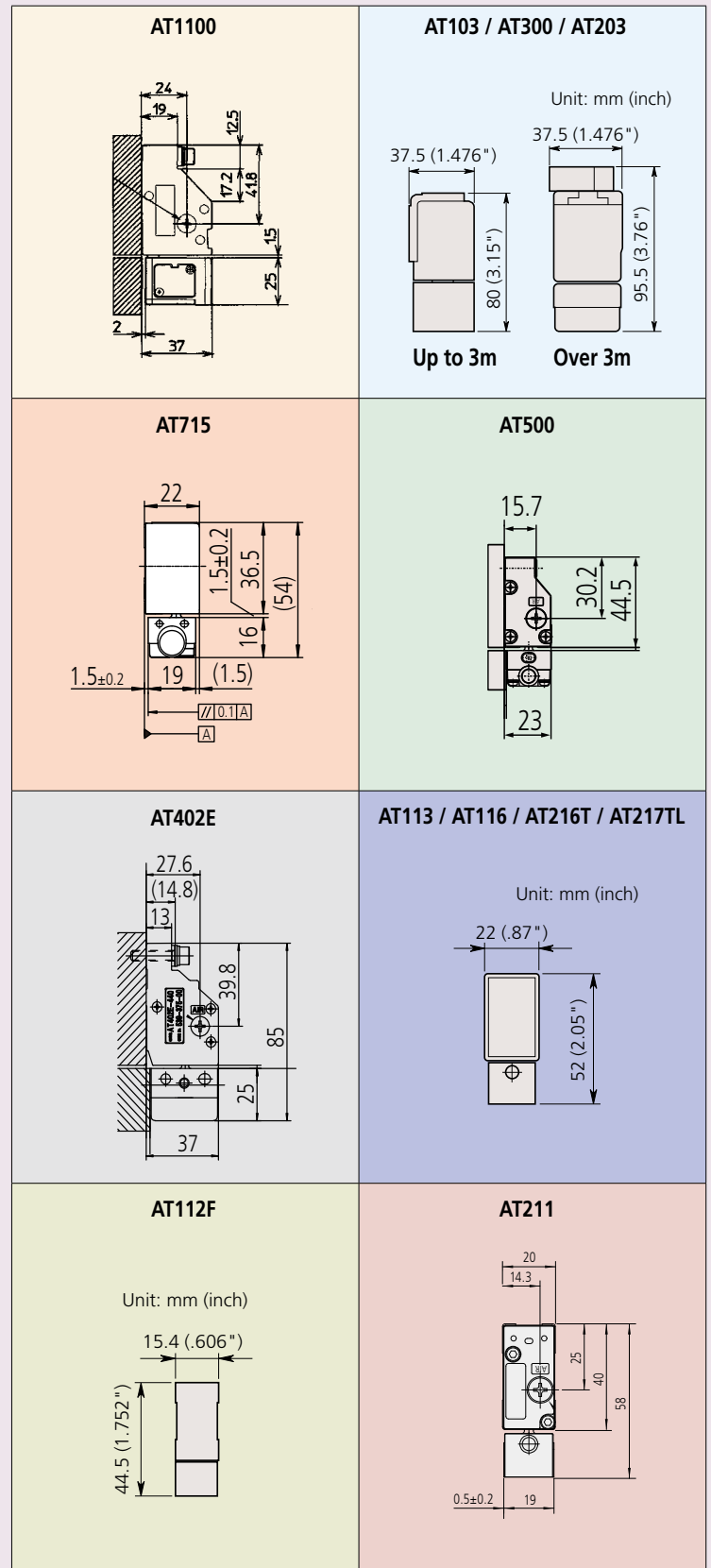

Linear Scales ABS AT1100

SERIES 539 — General Mount Type, robust dustproof / waterproof structure



ABSOLUTE™

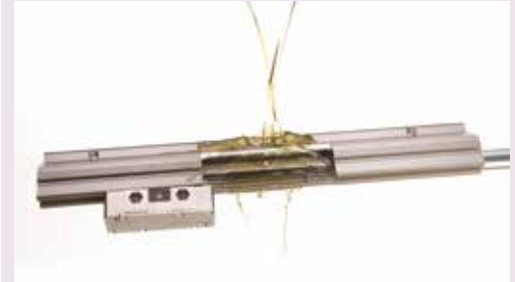

SPECIFICATIONS

Model	ABS AT1100
Detection method	Electromagnetic induction
Maximum effective range	3040mm
Resolution	0.05μm
Accuracy (at 20 °C)	(3+5L/1000)μm L= 140 to 2040mm (5+5L/1000)μm L= 2240 to 3040mm
Maximum response speed	3 m/s
Cross-section size	85x37 (mm)
Thermal expansion coefficient	≈ 8±1.5x10 ⁻⁶ / K
Vibration resistance (at 55 to 2000Hz)	20g
Impact resistance (at 11ms, 1/2sin)	35g L=140 to 2040mm 30g L=2240 to 3040mm
Compatible interfaces *1	FANUC Corporation's Serial α Interface (AT1153) Mitsubishi Electric Corporation's High-speed Serial Interface (AT1143)

*1: For details about connection of any applicable system, please be sure to contact each manufacturer for confirmation.

- Electromagnetic induction principle means scales are unaffected by most contamination.
- Absolute scales have eliminated the need for origin restoration and drastically reduced power consumption.
- Drawings are available on request.

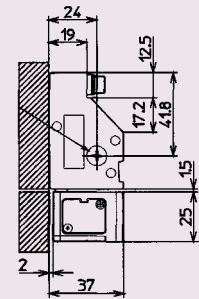

AT1100 Mounting Dimensions

FANUC		Mitsubishi		Siemens		Effective Range (mm)
Order No.	Model	Order No.	Model	Order No.	Model	
559-100-53	AT1153-140	559-100-43	AT1143-140	559-100-23	AT1123-140	140
559-101-53	AT1153-240	559-101-43	AT1143-240	559-101-23	AT1123-240	240
559-102-53	AT1153-340	559-102-43	AT1143-340	559-102-23	AT1123-340	340
559-103-53	AT1153-440	559-103-43	AT1143-440	559-103-23	AT1123-440	440
559-104-53	AT1153-540	559-104-43	AT1143-540	559-104-23	AT1123-540	540
559-105-53	AT1153-640	559-105-43	AT1143-640	559-105-23	AT1123-640	640
559-106-53	AT1153-740	559-106-43	AT1143-740	559-106-23	AT1123-740	740
559-107-53	AT1153-840	559-107-43	AT1143-840	559-107-23	AT1123-840	840
559-108-53	AT1153-940	559-108-43	AT1143-940	559-108-23	AT1123-940	940
559-109-53	AT1153-1040	559-109-43	AT1143-1040	559-109-23	AT1123-1040	1040
559-110-53	AT1153-1140	559-110-43	AT1143-1140	559-110-23	AT1123-1140	1140
559-111-53	AT1153-1240	559-111-43	AT1143-1240	559-111-23	AT1123-1240	1240
559-112-53	AT1153-1340	559-112-43	AT1143-1340	559-112-23	AT1123-1340	1340
559-113-53	AT1153-1440	559-113-43	AT1143-1440	559-113-23	AT1123-1440	1440
559-114-53	AT1153-1540	559-114-43	AT1143-1540	559-114-23	AT1123-1540	1540
559-115-53	AT1153-1640	559-115-43	AT1143-1640	559-115-23	AT1123-1640	1640
559-116-53	AT1153-1740	559-116-43	AT1143-1740	559-116-23	AT1123-1740	1740
559-117-53	AT1153-1840	559-117-43	AT1143-1840	559-117-23	AT1123-1840	1840
559-118-53	AT1153-2040	559-118-43	AT1143-2040	559-118-23	AT1123-2040	2040
559-119-53	AT1153-2240	559-119-43	AT1143-2240	559-119-23	AT1123-2240	2240
559-120-53	AT1153-2440	559-120-43	AT1143-2440	559-120-23	AT1123-2440	2440
559-121-53	AT1153-2640	559-121-43	AT1143-2640	559-121-23	AT1123-2640	2640
559-122-53	AT1153-2840	559-122-43	AT1143-2840	559-122-23	AT1123-2840	2840
559-123-53	AT1153-3040	559-123-43	AT1143-3040	559-123-23	AT1123-3040	3040



ABSOLUTE™

Linear Scales ABS AT300

SERIES 539 — Standard Type

- ABSOLUTE linear encoder incorporates both our unique electrostatic capacity and photoelectric technology.
- * Refer to page H-34 "Quick Guide to Precision Measuring Instruments" for details of the principle of the absolute linear scale.
- Drastically reduced power consumption since there are no backup batteries.
- Easy operation because no recalibration is required at startup or after a power failure.
- Suitable for position feedback in machinery requiring high-accuracy, high-speed control.
- Improved environmental resistance against mechanical vibration and noise.



SPECIFICATIONS

Model	ABS AT353	ABS AT343	ABS AT343A	ABS AT303	ABS AT303A
Applicable system	FANUC Ltd. NC Control unit	Mitsubishi Electric Corporation MITSUBISHI CNC series	Mitsubishi Electric Corporation MR-J3	Amplifiers supporting Mitutoyo ENSIS interface	
Resolution	0.05μm				
Maximum response speed	120m/min				
Effective range	4 to 120" / 100 to 3000mm				
Accuracy (20°C)*	(3+3L _o /1000)μm, (5+5L _o /1000)μm when the effective range is 1600mm or more				
Protection level	IP53				

* The indication accuracy does not include quantizing error. L_o: Effective range (mm)

* A wide variety of special orders are available.

Dimensions

Effective range L _o (mm)	Maximum travel length L _t (mm)	Overall length L _z (mm)	Mounting block pitch		No. of mounting blocks	
			L ₁ (mm)	L ₂ (mm)		
100	120	230	65	100	2	
150	170	280	65	150		
200	220	330	65	200		
250	270	380	65	250		
300	330	440	220	150		
350	380	490	245	175		
400	430	540	270	200	3	
450	480	590	295	225		
500	540	650	325	250		
600	650	760	380	300		
700	760	870	435	350		
750	810	920	460	375		
800	860	970	485	400	5	
900	960	1070	535	450		
1000	1060	1170	585	500		
1100	1160	1270	635	275		7
1200	1260	1370	685	300		
1300	1360	1470	735	325		
1400	1460	1570	785	350		
1500	1560	1670	835	375		
1600	1690	1800	900	400		
1700	1790	1900	950	425	9	
1800	1890	2000	1000	450		
2000	2100	2210	1105	335		
2200	2300	2410	1205	370		
2400	2500	2610	1305	400		
2500	2600	2710	1355	315		
2600	2700	2810	1405	325		
2800	2900	3010	1505	350		
3000	3050	3210	1605	375		

Mounting dimensions [ABS AT353/AT343(A)/AT303(A)]

• Effective range 100 mm to 250mm

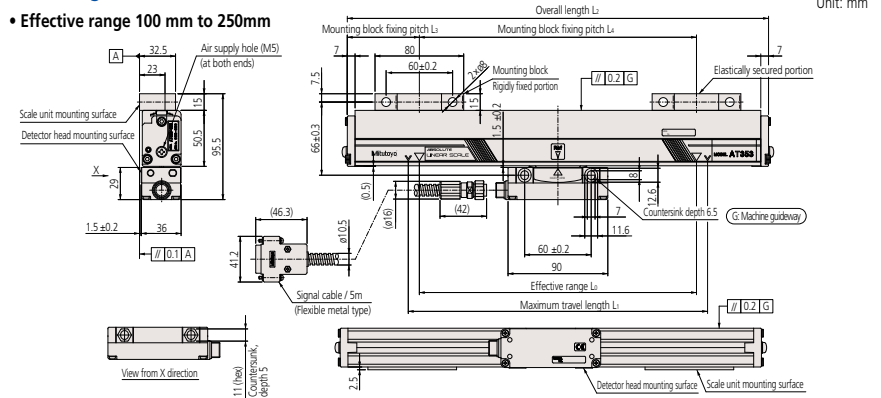

• ABS AT343A signal cable

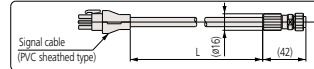

* The signal cable has set options.
(Part No.09BAA598A - C: 0.2m, 2m, 3m)

• Effective range 300mm to 3000mm

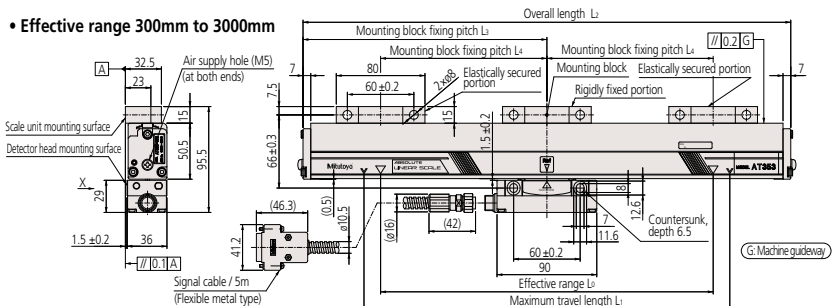

Linear Scales ABS AT715

SERIES 539 — Slim Spar Type



IP67

SPECIFICATIONS

Model	ABS AT715	
Detection method	Electromagnetic induction	
Resolution	.000020" - .001" (0.0005mm to 0.01mm) (on the KA/KLD200 counter)	
Effective range	100 to 3000mm	
Accuracy (20°C)	±5µm (Lo: 100 to 500mm), ±7µm (Lo: 600 to 1800mm), ±10µm (Lo: 2000 to 3000mm) Lo: Effective range (mm)	
Maximum response speed	50m/min	
Protection level	IP67	
Sliding force	5N or less	
Signal cable	Standard accessory Refer to the dimension table shown below for the length.	
Extension cable (optional)	Length	Order No.
	2m	09AAB674A
	5m	09AAB674B
7m	09AAB674C	
Connectable counter	KA Counter/ KLD200 Counter	

AT715		Effective range Lo inch/mm	Signal cable length (m)
Order No.	Model		
539-801	ABS AT715-100	4" /100mm	3.5
539-802	ABS AT715-150	6" /150mm	
539-803	ABS AT715-200	8" /200mm	
539-804	ABS AT715-250	10" /250mm	
539-805	ABS AT715-300	12" /300mm	
539-806	ABS AT715-350	14" /350mm	
539-807	ABS AT715-400	16" /400mm	
539-808	ABS AT715-450	18" /450mm	
539-809	ABS AT715-500	20" /500mm	
539-811	ABS AT715-600	24" /600mm	
539-813	ABS AT715-700	28" /700mm	
539-814	ABS AT715-750	30" /750mm	5
539-815	ABS AT715-800	32" /800mm	
539-816	ABS AT715-900	36" /900mm	
539-817	ABS AT715-1000	40" /1000mm	
539-818	ABS AT715-1100	44" /1100mm	
539-819	ABS AT715-1200	48" /1200mm	
539-820	ABS AT715-1300	52" /1300mm	
539-821	ABS AT715-1400	56" /1400mm	
539-822	ABS AT715-1500	60" /1500mm	
539-823	ABS AT715-1600	64" /1600mm	
539-824	ABS AT715-1700	68" /1700mm	
539-825	ABS AT715-1800	72" /1800mm	7*1
539-860	ABS AT715-2000	80" /2000mm	
539-861	ABS AT715-2200	88" /2200mm	
539-862	ABS AT715-2400	96" /2400mm	
539-863	ABS AT715-2500	100" /2500mm	
539-864	ABS AT715-2600	104" /2600mm	
539-865	ABS AT715-2800	112" /2800mm	
539-866	ABS AT715-3000	120" /3000mm	

*1: Combination of a 5m signal cable and a 2m extension cable

ABSOLUTE™



- Electromagnetic induction principle means scales are unaffected by contamination.
- Absolute scales have eliminated the need for origin restoration and drastically reduced power consumption.
- Suitable for milling machines, XY tables, jigs, etc.

Optional Accessories

- 09AAB674A Extension cable 2m
- 09AAB674B Extension cable 5m
- 09AAB674C Extension cable 7m
- 174-183A 2-Axis KA Counter
- 174-185A 3-Axis KA Counter



174-183A

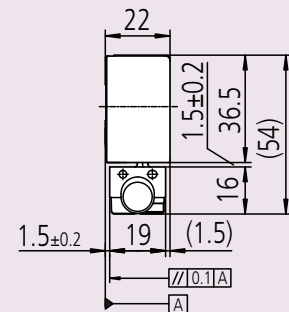



Linear Scales ABS AT500

SERIES 539 — Slim Spar Type

- Slim shape is suitable for space-saving designs.
- The high-rigidity **ABS AT500-S** series has vibration resistance, shock resistance and temperature control. The **ABS AT500-H** series offers excellent temperature control and high accuracy.
- Scale alarm display LED allows for easy maintenance.
- Supports the interfaces of various manufacturers, allowing a variety of system configurations.

SC Type

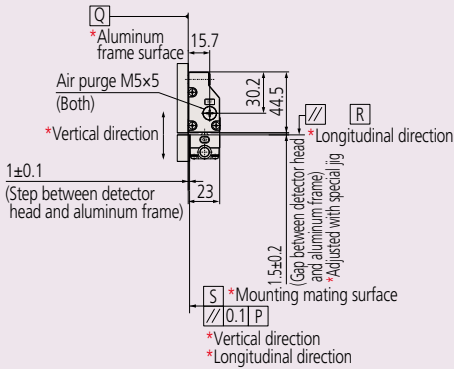

SPECIFICATIONS

	High-rigidity type	High-accuracy type	
Model	ABS AT500-SC	ABS AT500-HC	ABS AT500-HL/HR
Resolution	0.005μm*1/0.05μm		
Maximum response speed	150m/min (72m/min for the H series whose resolution is 0.005μm)		
Effective range	100 to 2200mm	100 to 1000mm	100 to 350mm
Accuracy (20°C)*2	(3+3L _a /1000)μm		(2+2L _a /1000)μm
Reference point of expansion influenced by the temperature fluctuation	Center of the effective measuring length		Edge of the effective measuring length HL: "+" side of the absolute value HR: "-" side of the absolute value
Protection level	IP53		

*1: The exact value is 0.0048828125μm since the 20μm signal is divided by 4096.

Meaning of Model No.

ABS AT5□□□ - □□□ - □□

Resolution/Applicable system

Effective range

Model	Resolution	Applicable system
ABS AT553	0.05μm	FANUC Ltd.
ABS AT555	0.005μm	NC Control unit
ABS AT543	0.05μm	Mitsubishi Electric Corporation MITSUBISHI CNC series
ABS AT545	0.005μm	Mitsubishi Electric Corporation MELSERVO series
ABS AT543A	0.05μm	Panasonic Corporation, Motor Business Unit MINAS series*1
ABS AT545A	0.005μm	
ABS AT573A	0.05μm	Amplifiers supporting Mitutoyo ENSIS interface*1 (Nikki Denso Co., Ltd., Servoland corporation, PMAC Japan Co., Ltd.)
ABS AT503	0.05μm	
ABS AT503A	0.05μm	
ABS AT505	0.005μm	
ABS AT505A	0.005μm	Siemens AG SINAMICS/SINUMERIK series (supporting DRIVE-CLiQ)
ABS AT524	0.01μm	
ABS AT527	0.001μm	

Reference point of expansion on the scale unit influenced by temperature fluctuation*
C: Center of the effective range
L: "+" side of the absolute value
R: "-" side of the absolute value
 * "L" or "R" is marked only for the high accuracy type.

Type of the scale unit
S: High rigidity type
H: High accuracy type
 Note: "Reference point of expansion"
 The scale unit expands or contracts influenced by the temperature fluctuation.
 The mechanical reference point of expansion is defined as the reference point.

*ABS AT5□□□
 Transmission method
 Nothing: Full duplex communication
A: Half-duplex communication

*1: Please contact each manufacturer for details.

Linear Scales ABS ST700

SERIES 579 — General-purpose Type

ABSOLUTE™

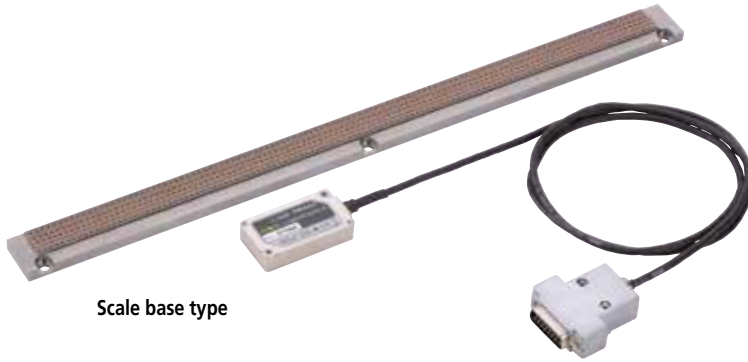

Scale base type

SPECIFICATIONS

Model	ABS ST700
Scale type	Scale base type
Resolution	0.1μm (0.05μm to special order)
Detection method	Electromagnetic induction ABS linear encoder
Max. effective range	6000mm
Accuracy (20°C)	5+(5L/1000)μm L: Effective range (mm)
Maximum response speed	5m/s
Linear expansion coefficient	(12.0±1.5)×10 ⁻⁶ /°C (When the material of the mounting components is steel or equivalent.)
Power supply voltage	5V±10% (at the detection head) (Ripple + spike noise component should be less than 100mV.)
Operating temperature/humidity range	0 to 50°C, RH 20 to 80%
Storage temperature/humidity range	-20 to 70°C, RH 20 to 80%

Meaning of Model No.

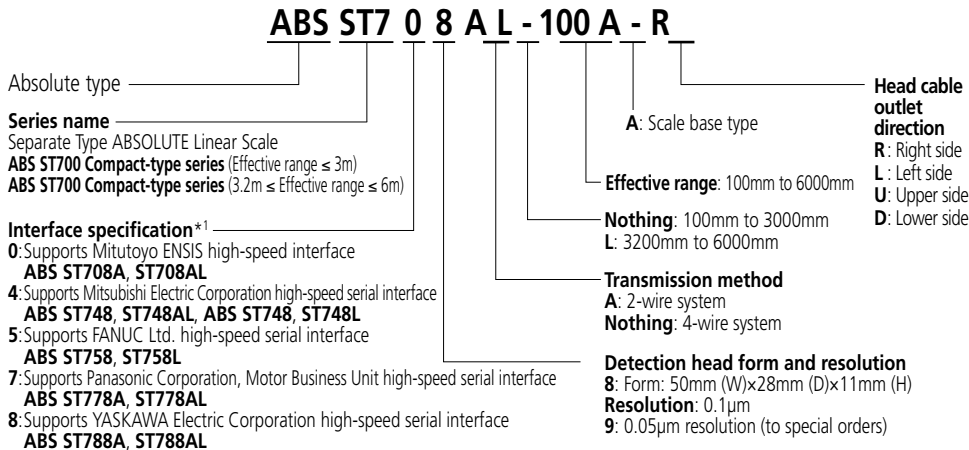

- Absolute measurement with exposed scales.
- Non-contact detection is optimal for high-speed and high-acceleration devices such as linear motors.
- Electromagnetic induction principle means scales are unaffected by water and oil contamination.
- The detector head is approximately 1/3 the previous model size: 50mm (W) × 28mm (D) × 11mm (H).
- Cable outlets can be in four directions, with mounting holes on the top and sides.
- Accuracy (5+5L/1000)μm, glass scale: (3+3L/1000)μm (previous models: (8+5L/1000)μm) L: Effective range (mm).
- Compatible with servo amplifiers from a range of companies (high-speed serial interfaces).
- Signal adjustment at installation is automatically performed with dedicated software.

Feedback cable

- Yaskawa Electric Corporation serial cable can be used as the feedback cable to connect to a Yaskawa Electric Corporation servo amplifier.
Cable model number : JZSP-CLP- (03, 05, 10, 15, 20)
- For the feedback cable to connect to a Mitsubishi Electric Corporation MR-J2S/MR-J3, contact Mitutoyo with the following code numbers.
For the MR-J2S 5m : No.06ACF116A
10m : No.06ACF116B
For the MR-J3 5m : No.06ACF117A
10m : No.06ACF117B

Available Interfaces*1

FANUC Ltd. FS-i Series, Power Mate i Series
Mitsubishi Electric Corporation MELSERVO MR-J4/MR-J3 Series
Mitsubishi Electric Corporation CNC Series, MDS-D/MDS-DH Series
YASKAWA Electric Corporation Σ-V,Σ-III Series
Panasonic Corporation, Motor Business Unit MINAS-A5, A5L, A5N, A5NL, MINAS-A4, A4P, A4N, A4NL Series
Mitutoyo ENSIS*2
Nikki Denso Co.,Ltd. VCI/VC/PS series
Servoland Corporation SVF Series
PMAC Japan Co. Ltd. UMAC-Turbo PMAC2

*1 Be sure to contact each manufacturer for details of the applicable systems (availability of connection).

*2 ENSIS is a registered trademark of Mitutoyo Corporation.

Linear Scale ABS ST1300

SERIES 579 — High-speed, High-resolution Absolute Tape Scale

- 12m maximum effective length, 8-m/s max. response speed and 1nm minimum resolution.
- Extensive interface compatibility. See specifications below.
- Outstanding robustness against contamination compared to earlier photoelectric types by using a new detection principle.
- Choice between double-sided tape and tension mounting methods.
- Signal validation program facilitates mounting adjustment and maintenance.
- Applicable Interfaces: FANUC; Mitsubishi Electric; Yaskawa Electric; Panasonic; Mitutoyo ENSIS standard interface

- Any scale size drawings are available on request.

Double-end tension version



Double-sided adhesive mounting version

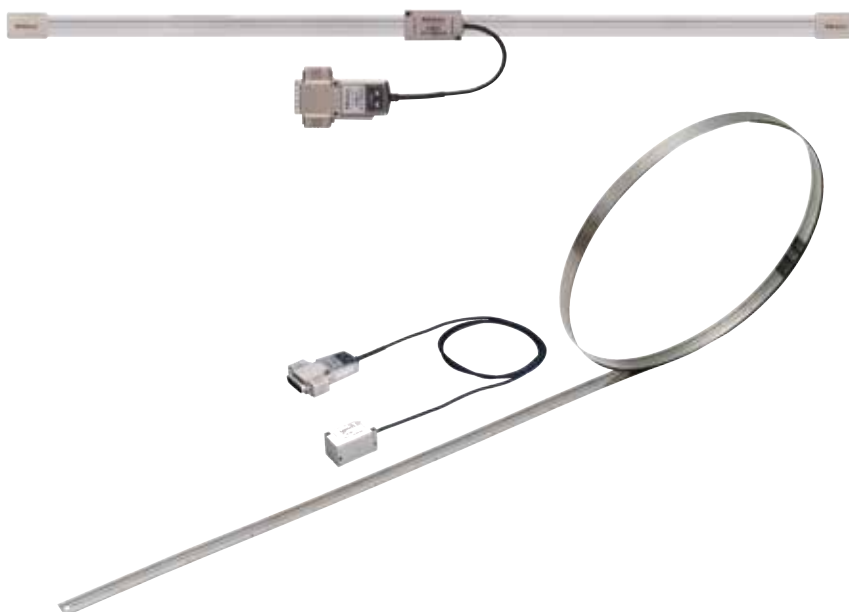

SPECIFICATIONS

Model	ABS ST1300
Range	max. 12 m
Accuracy	10 $\mu\text{m}/\text{m}$ ($\pm 5\mu\text{m}$)
Max. Response Speed	8 m/s (Varies according to the interface)
Min. Resolution	1 nm / 10 nm
Scale Specifications	Metal tape
Applicable Interfaces	FANUC; Mitsubishi Electric; Yaskawa Electric; Panasonic; Mitutoyo ENSIS standard Interface

MICSYS

SERIES 549 High-accuracy, Non-contact 2D Encoder



SPECIFICATIONS

Order No.	549-701A
Model	MICSYS-SA1
Detection method	Laser speckle image correlation
Effective range	$\pm 100\mu\text{m}$ (2D)
Resolution	1 nm
Accuracy (20°C)	± 100 nm
Data update period	20Hz

Applications

1. Evaluation of stages used in manufacturing equipment and inspection systems

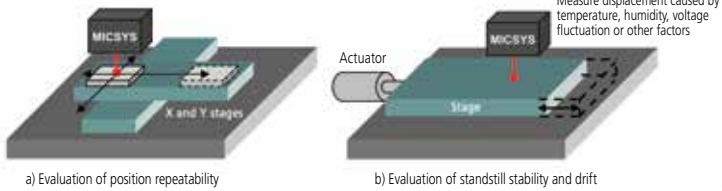

2. Highly accurate positioning of workpieces

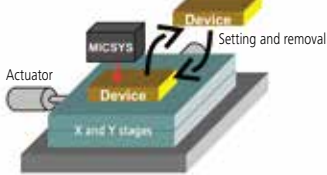

3. Measurement of minute displacement

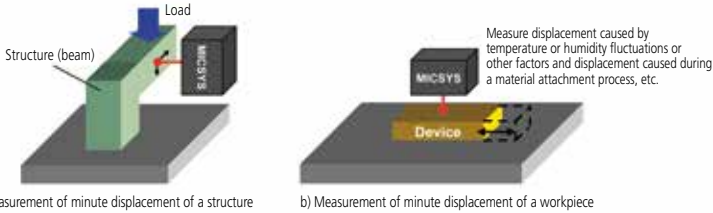

DIMENSIONS

Detector Mass : 300g

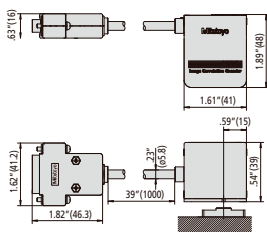

Standard target Mass : 10g

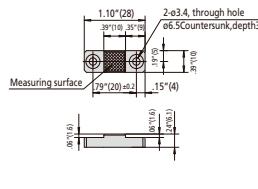

I/F unit Mass : 1700g

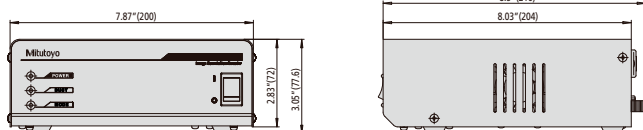

FEATURES

- Simultaneous, non-contact measurement of X-Y position.
- Nano-resolution measurement.
- Suitable for applications such as stage position repeatability, strain measurement, deflection measurement, etc.
- Applies the image correlation of a speckle pattern.
- No scales needed—can detect on any optically rough surface.
- Detector can be completely removed from surface and replaced to continue reading.
- Drawings are available on request.



Linear Scales AT103

SERIES 539 — Standard Type



FEATURES

- Enhanced vibration-resistance and durability.
- The innovative rubber lips keep out contaminants.
- An armored signal cable is used to connect the scale unit to the DRO counter for safe operation in harsh shop environments.
- The signal cable outlet can be positioned on either side of the detector head, allowing the signal cable to be connected from either direction.
- A wide variety of measuring ranges are available in this standard type scale unit.
- Connectable to the **KA** counter, **KLD** counter, or **PSU-200**.

Optional Accessories

- 09AAA033A:** Extension cable (80" / 2m)
- 09AAA033B:** Extension cable (200" / 5m)
- 09AAA033C:** Extension cable (280" / 7m)



- 174-183A** 2-Axis KA Counter
- 174-185A** 3-Axis KA Counter



174-183A

Unit: mm (inch)

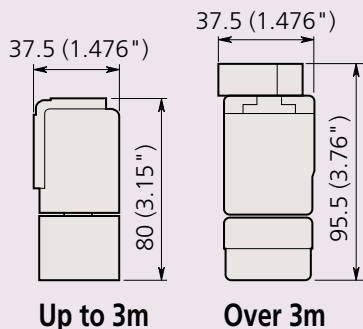

SPECIFICATIONS

Model	AT103
Effective range	4" to 240" / 100 to 6000mm (42 models)
Resolution	.001" to .000005" / 0.01 to 0.0001mm
Accuracy (20°C)	Effective range 100 to 3000: (5+5L ₀ /1000)μm Effective range 3250 to 6000: (5+8L ₀ /1000)μm
Output signal	Two 90° phase-shifted sinusoidal signals
Maximum response speed	120m/min (50m/min when the effective measuring length is 3250 to 6000mm)
Signal output pitch	20μm
Scale reference point	Output in 50mm pitch
Protection level	IP53
Operating temperature	0 to 45°C

* High-precision model **AT103F** (JIS Class 0, (3+3L₀/1000)μm) is also available to special order for the effective range of 100 to 2000mm.

* Ultrahigh-precision model **AT103S** (2+2L₀/1000)μm is also available to special order for the effective range of 100 to 500mm.

AT103				Effective range L ₀ inch / mm	Signal cable length (m)
Order No. (standard)	Model (standard)	Order No. (high accuracy)	Model (high accuracy)		
539-111-30	AT103-100	539-111-40	AT103-100F	4" /100mm	3
539-112-30	AT103-150	539-112-40	AT103-150F	6" /150mm	
539-113-30	AT103-200	539-113-40	AT103-200F	8" /200mm	
539-114-30	AT103-250	539-114-40	AT103-250F	10" /250mm	
539-115-30	AT103-300	539-115-40	AT103-300F	12" /300mm	
539-116-30	AT103-350	539-116-40	AT103-350F	14" /350mm	
539-117-30	AT103-400	539-117-40	AT103-400F	16" /400mm	
539-118-30	AT103-450	539-118-40	AT103-450F	18" /450mm	
539-119-30	AT103-500	539-119-40	AT103-500F	20" /500mm	
539-121-30	AT103-600	539-121-40	AT103-600F	24" /600mm	
539-123-30	AT103-700	539-123-40	AT103-700F	28" /700mm	
539-124-30	AT103-750	539-124-40	AT103-750F	30" /750mm	
539-125-30	AT103-800	539-125-40	AT103-800F	32" /800mm	
539-126-30	AT103-900	539-126-40	AT103-900F	36" /900mm	
539-127-30	AT103-1000	539-127-40	AT103-1000F	40" /1000mm	
539-128-30	AT103-1100	539-128-40	AT103-1100F	44" /1100mm	
539-129-30	AT103-1200	539-129-40	AT103-1200F	48" /1200mm	
539-130-30	AT103-1300	539-130-40	AT103-1300F	52" /1300mm	
539-131-30	AT103-1400	539-131-40	AT103-1400F	56" /1400mm	
539-132-30	AT103-1500	539-132-40	AT103-1500F	60" /1500mm	
539-133-30	AT103-1600	539-133-40	AT103-1600F	64" /1600mm	
539-134-30	AT103-1700	539-134-40	AT103-1700F	68" /1700mm	
539-135-30	AT103-1800	539-135-40	AT103-1800F	72" /1800mm	
539-136-30	AT103-2000	539-136-40	AT103-2000F	80" /2000mm	
539-137-30	AT103-2200	—	AT103-2200F	88" /2200mm	
539-138-30	AT103-2400	—	AT103-2400F	96" /2400mm	
539-139-30	AT103-2500	—	AT103-2500F	100" /2500mm	
539-140-30	AT103-2600	—	AT103-2600F	104" /2600mm	
539-141-30	AT103-2800	—	AT103-2800F	112" /2800mm	
539-142-30	AT103-3000	—	AT103-3000F	120" /3000mm	
539-143-30	AT103-3250	—	AT103-3250F	130" /3250mm	
539-144-30	AT103-3500	—	AT103-3500F	140" /3500mm	
539-145-30	AT103-3750	—	AT103-3750F	150" /3750mm	
539-146-30	AT103-4000	—	AT103-4000F	160" /4000mm	
539-147-30	AT103-4250	—	AT103-4250F	170" /4250mm	
539-148-30	AT103-4500	—	AT103-4500F	180" /4500mm	
539-149-30	AT103-4750	—	AT103-4750F	190" /4750mm	
539-150-30	AT103-5000	—	AT103-5000F	200" /5000mm	
539-151-30	AT103-5250	—	AT103-5250F	210" /5250mm	
539-152-30	AT103-5500	—	AT103-5500F	220" /5500mm	
539-153-30	AT103-5750	—	AT103-5750F	230" /5750mm	
539-154-30	AT103-6000	—	AT103-6000F	240" /6000mm	

Linear Scales AT113

SERIES 539 — Slim Spar Type

- Slim spar type with unit sectional dimensions of 22×35mm.
- Connectable to the **KA** counter, **KLD** counter or **PSU-200**.
- Dimensionally compatible with **AT116** linear scale units.



SPECIFICATIONS

Model	AT113
Effective range	4" to 60" / 100 to 1500mm (20 models)
Resolution	.001" to .000005" / 0.01 to 0.0001mm
Accuracy (20°C)	Standard: (5+5L ₀ /1000)μm, High accuracy: (3+3L ₀ /1000)
Output signal	Two 90° phase-shifted sinusoidal signals
Maximum response speed	120m/min
Signal output pitch	20μm
Scale reference point	Output in 50mm pitch
Protection level	IP53
Operating temperature	0 to 45°C

* High-precision model **AT113F** (JIS Class 0, 3+3L₀/1000)μm is also available to special order.

* Ultrahigh-precision model **AT113S** (2+2L₀/1000)μm is also available to special order for the effective range 100 to 500mm.

AT113				Effective range L ₀ inch / mm	Signal cable length(m)	
Order No. (standard)	Model	Order No. (High accuracy)	Model			
539-201-30	AT113-100	539-201-40	AT113-100F	4" /100mm	3	
539-202-30	AT113-150	539-202-40	AT113-150F	6" /150mm		
539-203-30	AT113-200	539-203-40	AT113-200F	8" /200mm		
539-204-30	AT113-250	539-204-40	AT113-250F	10" /250mm		
539-205-30	AT113-300	539-205-40	AT113-300F	12" /300mm		
539-206-30	AT113-350	539-206-40	AT113-350F	14" /350mm		
539-207-30	AT113-400	539-207-40	AT113-400F	16" /400mm		
539-208-30	AT113-450	539-208-40	AT113-450F	18" /450mm		
539-209-30	AT113-500	539-209-40	AT113-500F	20" /500mm		
539-211-30	AT113-600	539-211-40	AT113-600F	24" /600mm		
539-213-30	AT113-700	539-213-40	AT113-700F	28" /700mm		
539-214-30	AT113-750	539-214-40	AT113-750F	30" /750mm		
539-215-30	AT113-800	539-215-40	AT113-800F	32" /800mm		
539-216-30	AT113-900	539-216-40	AT113-900F	36" /900mm		
539-217-30	AT113-1000	539-217-40	AT113-1000F	40" /1000mm		5
539-218-30	AT113-1100	539-218-40	AT113-1100F	44" /1100mm		
539-219-30	AT113-1200	539-219-40	AT113-1200F	48" /1200mm		
539-220-30	AT113-1300	539-220-40	AT113-1300F	52" /1300mm		
539-221-30	AT113-1400	539-221-40	AT113-1400F	56" /1400mm		
539-222-30	AT113-1500	539-222-40	AT113-1500F	60" /1500mm		



Optional Accessories

09AAA033A: Extension cable (80" / 2m)

09AAA033B: Extension cable (200" / 5m)

09AAA033C: Extension cable (280" / 7m)



174-183A 2-Axis KA Counter

174-185A 3-Axis KA Counter



174-183A

Unit: mm (inch)

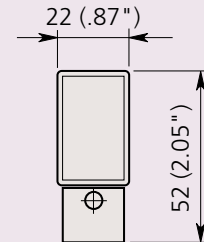



Linear Scales AT112-F

SERIES 539 — Super Slim Spar Type

- Super slim spar type with unit sectional dimensions of 15.4x30mm.
- Connectable to the **KA** counter, **KLD** counter or **PSU-200**.

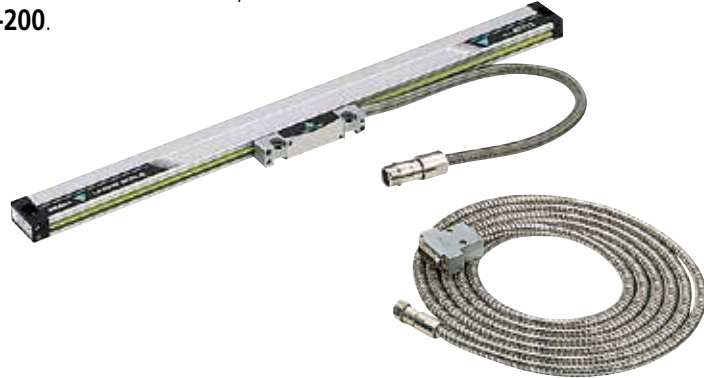

Optional Accessories

- 09AAA033A:** Extension cable (80" / 2m)
- 09AAA033B:** Extension cable (200" / 5m)
- 09AAA033C:** Extension cable (280" / 7m)



- 174-183A** 2-Axis KA Counter
- 174-185A** 3-Axis KA Counter



174-183A

Unit: mm (inch)

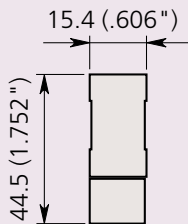

SPECIFICATIONS

Model	AT112-F (High Accuracy)
Effective range	1.5" to 40" / 50 to 1020mm (19 models)
Resolution	.001 to .000005" / 0.01mm to 0.0001mm
Accuracy (20°C)	(3+3L ₀ /1000)μm
Output signal	Two 90° phase-shifted sinusoidal signals
Maximum response speed	50m/min
Signal output pitch	20μm
Scale reference point	Output in 50mm pitch*1
Protection level	IP53
Operating temperature	0 to 45°C

* Ultra-high precision model **AT112S** (2+2L₀/1000)μm is also available to special order for the effective range 50 to 320mm.

*1: Models whose effective range is 50mm or 70mm: Center point

Models whose effective range is 120mm or more: 50mm pitch starting at a point 35mm from the "▼" mark on the left seen from the front.

AT112-F		Effective range L ₀ inch / mm	Signal cable length (m)
Order No.	Model		
539-251-10	AT112-50F	1.5" / 50mm	3
539-252-10	AT112-70F	2.5" / 70mm	
539-253-10	AT112-120F	4.5" / 120mm	
539-254-10	AT112-170F	6.5" / 170mm	
539-255-10	AT112-220F	8.5" / 220mm	
539-256-10	AT112-270F	10.5" / 270mm	
539-257-10	AT112-320F	12.5" / 320mm	
539-258-10	AT112-370F	14.5" / 370mm	
539-259-10	AT112-420F	16.5" / 420mm	
539-260-10	AT112-470F	18.5" / 470mm	
539-261-10	AT112-520F	20" / 520mm	
539-262-10	AT112-570F	22" / 570mm	
539-263-10	AT112-620F	24" / 620mm	
539-264-10	AT112-670F	26" / 670mm	
539-265-10	AT112-720F	28" / 720mm	
539-266-10	AT112-770F	30" / 770mm	
539-267-10	AT112-820F	32" / 820mm	
539-268-10	AT112-920F	36" / 920mm	
539-269-10	AT112-1020F	40" / 1020mm	

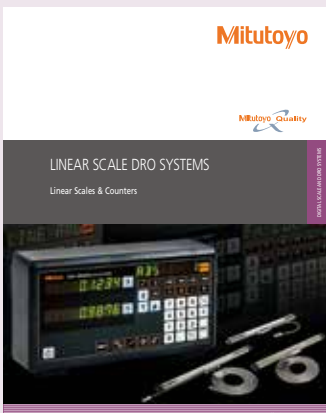

Refer to Bulletin No. (2217) for more details.

Linear Scales AT116

SERIES 539 — Economy and Slim Spar Type

FEATURES

- Suitable for milling machines, XY tables, jigs, etc.
- Dimensionally compatible with **AT113** linear scale units.
- Connectable to the **KA** counter, **KLD** counter or **PSU-200**.



SPECIFICATIONS

Model	AT116
Effective range	4" to 60" / 100 to 1500mm (20 models)
Resolution	0.01 to 0.0001mm (.001" to .00005")
Accuracy (20°C)	(5+5L α /1000) μ m
Output signal	Two 90° phase-shifted sinusoidal signals
Maximum response speed	50m/min
Signal output pitch	20 μ m
Scale reference point	Output in 50mm pitch
Protection level	IP53
Operating temperature	0 to 45°C

AT116		Effective range L α inch / mm	Signal cable length (m)
Order No.	Model		
539-271-30	AT116-100	4" /100mm	3.5
539-272-30	AT116-150	6" /150mm	
539-273-30	AT116-200	8" /200mm	
539-274-30	AT116-250	10" /250mm	
539-275-30	AT116-300	12" /300mm	
539-276-30	AT116-350	14" /350mm	
539-277-30	AT116-400	16" /400mm	
539-278-30	AT116-450	18" /450mm	
539-279-30	AT116-500	20" /500mm	
539-281-30	AT116-600	24" /600mm	
539-283-30	AT116-700	28" /700mm	
539-284-30	AT116-750	30" /750mm	
539-285-30	AT116-800	32" /800mm	
539-286-30	AT116-900	36" /900mm	
539-287-30	AT116-1000	40" /1000mm	5
539-288-30	AT116-1100	44" /1100mm	
539-289-30	AT116-1200	48" /1200mm	
539-290-30	AT116-1300	52" /1300mm	
539-291-30	AT116-1400	56" /1400mm	
539-292-30	AT116-1500	60" /1500mm	



Optional Accessories

- 09AAB674A:** Extension cable (2m / 80")
- 09AAB674B:** Extension cable (5m / 200")
- 09AAB674C:** Extension cable (7m / 280")



- 174-183A** 2-Axis KA Counter
- 174-185A** 3-Axis KA Counter



174-183A

Unit: mm (inch)

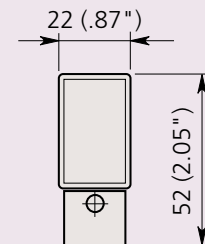



Linear Scales AT402E

SERIES 539 — General-purpose Type

- Ideal for machine tools for heavy cutting, as well as linear motors.
- Multi-point elastic fixing for excellent vibration resistance (200m/s²), shock resistance (400m/s²) and temperature characteristics.
- The Absolute Interval Code allows for a simplified, low-cost ABS system.
- High accuracy of ±2μm (up to 540mm)



SPECIFICATIONS

Model	AT402E
Effective range	5.6" to 121.6" / 140 to 3040mm (24 models)
Accuracy (20°C)	Effective range: 140 to 540mm: ±2μm Effective range: 640 to 940mm: ±3μm Effective range: 1040 to 3040mm: ±3μm/m
Output signal	Signal: 1Vp-p differential sinusoidal signal Differential reference point pulse: Absolute Interval Code compatible
Maximum response speed	120m/min (With sinusoidal signal amplitude of -3dB)
Signal output pitch	20μm
Protection level	IP53
Operating temperature	0 to 45°C
Cable configuration	Type A: 3m flying lead cable Type B: 3m cable with European CNC connectors Type C: 3m cable with FANUC connectors

Cable A: Lead wires type

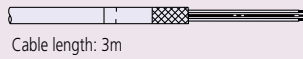

Cable length: 3m

Cable B: Connectable to Euro controller

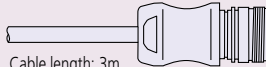

Cable length: 3m

Cable C: Connectable to FANUC serial board C

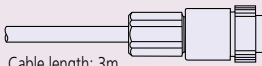

Cable length: 3m

AT402E		Effective range Lo inch / mm
Order No.	Model	
539-371-□□	AT402E-140	5.6" / 140mm
539-373-□□	AT402E-240	9.6" / 240mm
539-374-□□	AT402E-340	13.6" / 340mm
539-375-□□	AT402E-440	17.6" / 440mm
539-376-□□	AT402E-540	21.6" / 540mm
539-377-□□	AT402E-640	25.6" / 640mm
539-378-□□	AT402E-740	29.6" / 740mm
539-379-□□	AT402E-840	33.6" / 840mm
539-380-□□	AT402E-940	37.6" / 940mm
539-381-□□	AT402E-1040	41.6" / 1040mm
539-382-□□	AT402E-1140	45.6" / 1140mm
539-383-□□	AT402E-1240	49.6" / 1240mm

AT402E		Effective range Lo inch / mm
Order No.	Model	
539-384-□□	AT402E-1340	53.6" / 1340mm
539-385-□□	AT402E-1440	57.6" / 1440mm
539-386-□□	AT402E-1540	61.6" / 1540mm
539-387-□□	AT402E-1640	65.6" / 1640mm
539-388-□□	AT402E-1740	69.6" / 1740mm
539-389-□□	AT402E-1840	73.6" / 1840mm
539-390-□□	AT402E-2040	81.6" / 2040mm
539-391-□□	AT402E-2240	89.6" / 2240mm
539-392-□□	AT402E-2440	97.6" / 2440mm
539-393-□□	AT402E-2640	105.6" / 2640mm
539-394-□□	AT402E-2840	113.6" / 2840mm
539-395-□□	AT402E-3040	121.6" / 3040mm

Signal cable length: 3m

* The indication of "□□" in the code numbers will be **01** for Type A, **02** for Type B, **03** for Type C, and **00** for no cable

DIMENSIONS

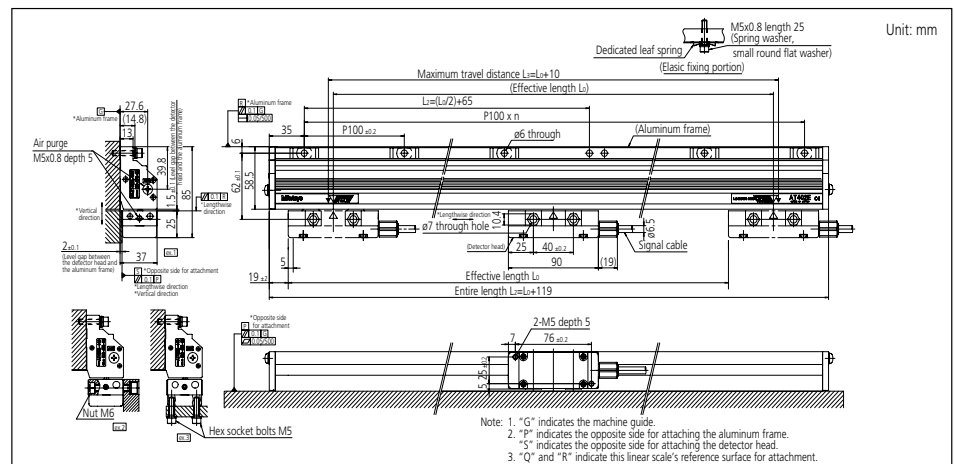

Linear Scales AT203

SERIES 539 — Standard Type



SPECIFICATIONS

Model	AT203
Effective range	4" to 240" / 100 to 6000mm (42 models)
Accuracy (20°C)	Effective range: 100 to 1500mm (3+3L ₀ /1000)μm Effective range: 1600 to 3000mm (5+5L ₀ /1000)μm Effective range: 3250 to 6000mm (5+8L ₀ /1000)μm
Output signal	Two 90° phase-shifted square wave signals
Maximum response speed	120m/min (50m/min when the effective range is 3250 to 6000mm)
Resolution	0.1/0.5/1μm (Switchable by the DIP switches)
Scale reference point	Output in 50mm pitch
Protection level	IP53
Operating temperature	0°C to 45°C

AT203		Effective range L ₀ inch / mm	Signal cable length (m)
Order No.	Model		
539-411-30	AT203-100	4" /100mm	
539-412-30	AT203-150	6" /150mm	
539-413-30	AT203-200	8" /200mm	
539-414-30	AT203-250	10" /250mm	
539-415-30	AT203-300	12" /300mm	
539-416-30	AT203-350	14" /350mm	
539-417-30	AT203-400	16" /400mm	
539-418-30	AT203-450	18" /450mm	
539-419-30	AT203-500	20" /500mm	
539-421-30	AT203-600	24" /600mm	
539-423-30	AT203-700	28" /700mm	
539-424-30	AT203-750	30" /750mm	
539-425-30	AT203-800	32" /800mm	
539-426-30	AT203-900	36" /900mm	
539-427-30	AT203-1000	40" /1000mm	
539-428-30	AT203-1100	44" /1100mm	
539-429-30	AT203-1200	48" /1200mm	
539-430-30	AT203-1300	52" /1300mm	
539-431-30	AT203-1400	56" /1400mm	
539-432-30	AT203-1500	60" /1500mm	
539-433-30	AT203-1600	64" /1600mm	
539-434-30	AT203-1700	68" /1700mm	
539-435-30	AT203-1800	72" /1800mm	
539-436-30	AT203-2000	80" /2000mm	
539-437-30	AT203-2200	88" /2200mm	
539-438-30	AT203-2400	96" /2400mm	
539-439-30	AT203-2500	100" /2500mm	
539-440-30	AT203-2600	104" /2600mm	
539-441-30	AT203-2800	112" /2800mm	
539-442-30	AT203-3000	120" /3000mm	
539-443-30	AT203-3250	130" /3250mm	
539-444-30	AT203-3500	140" /3500mm	
539-445-30	AT203-3750	150" /3750mm	
539-446-30	AT203-4000	160" /4000mm	
539-447-30	AT203-4250	170" /4250mm	
539-448-30	AT203-4500	180" /4500mm	
539-449-30	AT203-4750	190" /4750mm	
539-450-30	AT203-5000	200" /5000mm	
539-451-30	AT203-5250	210" /5250mm	
539-452-30	AT203-5500	220" /5500mm	
539-453-30	AT203-5750	230" /5750mm	
539-454-30	AT203-6000	240" /6000mm	

- The travel length of the linear scale is output with 2-phase square wave signals, which can be used as a feedback signal for NC machine tools.
- The pulse signal unit (PSU) is no longer needed, and the **AT203** can be directly connected to an NC machine tool.

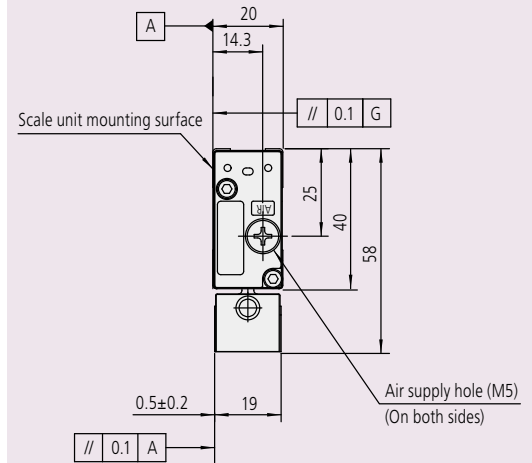

- Any scale size drawings are available on request.



Linear Scales AT216-T / AT217-TL

SERIES 529 — Slim, Sealed Type



- Slim, sealed type incremental linear scales suitable for feedback systems in NC machine tools.
- Direct connection with NC machine tools is possible.
- Square wave RS-422A, 1µm/0.5µm & 5µm resolution.
- Armored cable included (unless otherwise specified)

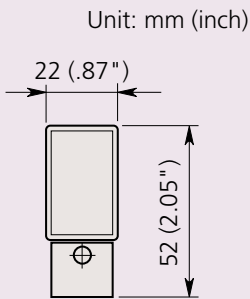

5µm resolution

AT216-T		Effective range L ₀ inch / mm	Signal cable length (m)
Order No.	Model		
529-431-3	AT216-100T	4" /100mm	5
529-432-3	AT216-150T	6" /150mm	
529-433-3	AT216-200T	8" /200mm	
529-434-3	AT216-250T	10" /250mm	
529-435-3	AT216-300T	12" /300mm	
529-436-3	AT216-350T	14" /350mm	
529-437-3	AT216-400T	16" /400mm	
529-438-3	AT216-450T	18" /450mm	
529-439-3	AT216-500T	20" /500mm	
529-441-3	AT216-600T	24" /600mm	
529-443-3	AT216-700T	28" /700mm	
529-444-3	AT216-750T	30" /750mm	
529-445-3	AT216-800T	32" /800mm	
529-446-3	AT216-900T	36" /900mm	
529-447-3	AT216-1000T	40" /1000mm	
529-448-3	AT216-1100T	44" /1100mm	
529-449-3	AT216-1200T	48" /1200mm	
529-450-3	AT216-1300T	52" /1300mm	
529-451-3	AT216-1400T	56" /1400mm	
529-452-3	AT216-1500T	60" /1500mm	

- Any scale size drawings are available on request.

1µm/0.5µm resolution

AT217-TL		Effective range L ₀ inch / mm	Signal cable length (m)
Order No.	Model		
529-461-5 (-7)	AT217-100TL	4" /100mm	5
529-462-5 (-7)	AT217-150TL	6" /150mm	
529-463-5 (-7)	AT217-200TL	8" /200mm	
529-464-5 (-7)	AT217-250TL	10" /250mm	
529-465-5 (-7)	AT217-300TL	12" /300mm	
529-466-5 (-7)	AT217-350TL	14" /350mm	
529-467-5 (-7)	AT217-400TL	16" /400mm	
529-468-5 (-7)	AT217-450TL	18" /450mm	
529-469-5 (-7)	AT217-500TL	20" /500mm	
529-471-5 (-7)	AT217-600TL	24" /600mm	
529-473-5 (-7)	AT217-700TL	28" /700mm	
529-474-5 (-7)	AT217-750TL	30" /750mm	
529-475-5 (-7)	AT217-800TL	32" /800mm	
529-476-5 (-7)	AT217-900TL	36" /900mm	
529-477-5 (-7)	AT217-1000TL	40" /1000mm	
529-478-5 (-7)	AT217-1100TL	44" /1100mm	
529-479-5 (-7)	AT217-1200TL	48" /1200mm	
529-480-5 (-7)	AT217-1300TL	52" /1300mm	
529-481-5 (-7)	AT217-1400TL	56" /1400mm	
529-482-5 (-7)	AT217-1500TL	60" /1500mm	

(-7) : option for unarmored cable

Linear Scales AT211

AT211-A (Multipoint mounting), AT211-B (Double-end mounting)
SERIES 539 — Slim Spar and High-speed Type



FEATURES

- High-resolution, high-accuracy sealed type linear scales. Ideal for feedback control in positioning a semiconductor manufacturing system, CNC machine tool, etc.
- Two types of models are available: the AT211-A, the multiple-point installation type designed for improved resistance against vibration and shock; and the AT211-B, which attaches to a machine at both ends. The AT211-B is compatible with the AT113/AT116 slim type in size.
- This is a slim, sealed, 2-phase, square-wave scale that can be directly connected to a control unit.
- Scale alarm display LED allows for easy maintenance.
- A wide range of specifications to best suit your application.
- Suitable for the control of semiconductor manufacturing systems and NC machine tools.



Common specification

Model	AT211
Effective range*	4 to 60" / 100 to 1500mm (20 models)
Accuracy (20°C)*	(3+3L _o /1000)μm L _o : effective range (mm) (2+2L _o /1000)μm (L _o ≤500mm)
Output signal	Two 90° phase-shifted square wave signals
Maximum response speed*	5.4 to 120m/min (varies depending on the resolution or minimum edge interval)
Resolution*	0.1/ 0.2/ 0.5/ 1.0/ 2.5/ 5.0μm
Scale reference point*	50mm/Center point/Left-edge point/Right-edge point
Protection level	IP53
Operating temperature	0 to 45°C

* Desired specification is selectable.

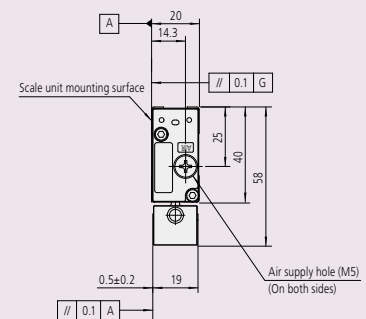

Meaning of Model No.

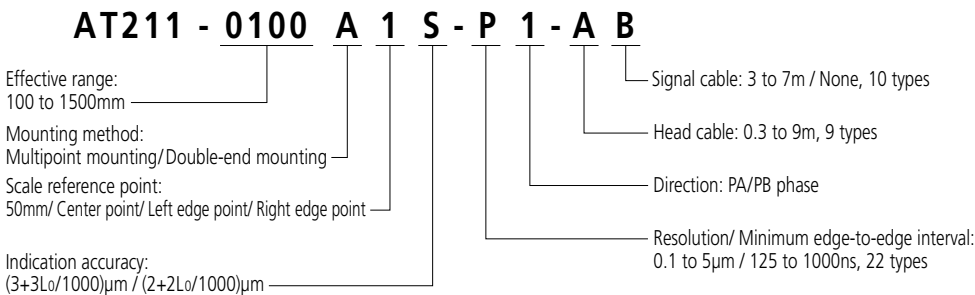

- Any scale size drawings are available on request.

Linear Scales ST46-EZA

SERIES 579 — Compact Type

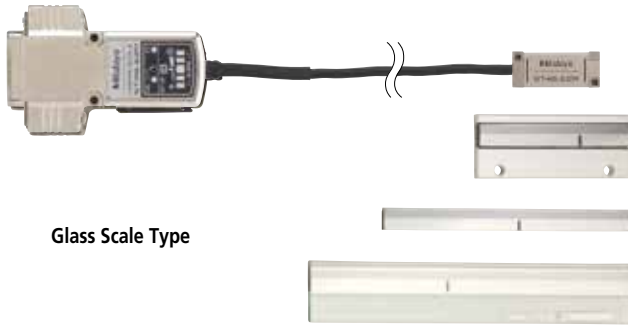

Glass Scale Type



Metal Tape Scale Type

•Double-end fixing tensioned design

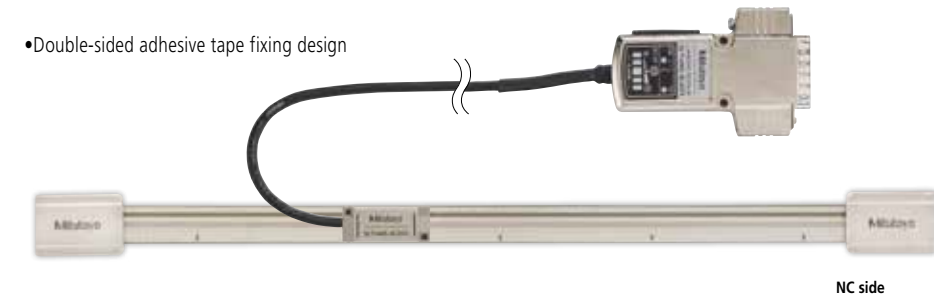

•Double-sided adhesive tape fixing design

NC side

SPECIFICATIONS

Model	ST46-EZA	
Detection method	Reflective photoelectric linear encoder	
Scale type	Glass	Metal tape
Main scale grating pitch	20μm	
Output signal	Type B: 2-phase square wave signals, reference point pulse, external reset input. Type C: 2-phase square wave signals, reference point pulse, 2-phase sinusoidal signals.	
Effective range	10 to 3000mm	
Resolution	0.05μm to 5 μm	
Accuracy (20°C)	Effective range 10 to 300mm: ±1μm Effective range 350 to 500mm: ±2μm Effective range 600 to 1000mm: ±3μm Effective range 1100 to 3000mm: ±3μm/m	Effective range 10 to 1000mm: ±5μm Effective range 1100 to 3000mm: ±5μm/m (The above accuracy applies to individual scales. For double-end fixing designs, perform point-to-point correction after ensuring the metal tape is tensioned correctly.)
Maximum response speed	2.6m/s (With sinusoidal signal amplitude of -3dB)	
Scale reference point	50mm pitch, 10 to 80mm: Center point	
Power supply voltage	5VDC±5%	
Operating temperature/humidity range	0 to 40°C, RH 20 to 80% (no condensation)	
Storage temperature/humidity range	-20 to 60°C, RH 20 to 80% (no condensation)	

- Includes an automatic adjusting function for the signal (EZA function) at the push of a button.
- Detector head mounting and signal adjustment possible without oscilloscope or PC.
- A setup indicator for checking signal strength is included.
- I/F circuit integrated in connector shell reduces volume to 60% compared to conventional interface.
- Self-diagnosis function with USB connectivity facilitates signal strength checking and parameter setup.
- Glass and metal tape scales are available.
- The thickness of the detector head is only 7.5 mm. The metal tape scale type has a mounting surface area of 12.5 by 9.325 mm, allowing use in applications where a space-saving design is important.
- Drawings are available on request

Adjustment SW / CAL display / Reference point display

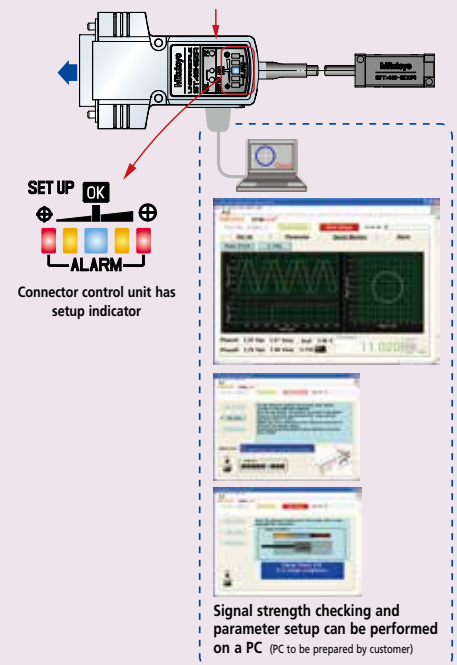

Signal strength checking and parameter setup can be performed on a PC (PC to be prepared by customer)



Linear Scales ST36

SERIES 579 — High-accuracy Type



- Outputs two-phase sinusoidal wave signal, two-phase pulse signal, and 1Vp-p at 4μm pitch.
- High-accuracy type, 0.5μm class (effective range up to 300mm)
- Has a thinner detector head (thickness 11.5mm).
- The maximum effective measurement range of 3000mm allows use on large machines.
- Four types available for each signal output specification.
- LED function for indicating signal errors.
- Along with the output specifications of 2-phase sinusoidal wave and 2-phase square wave, the output specification of 1Vp-p wave is available.

SPECIFICATIONS

Model	ST36
Detection method	Reflective photoelectric linear encoder
Output signal	ST36A: 2-phase sinusoidal signals ST36B: 2-phase square wave signals, alarm reset input ST36C: 2-phase square wave signals, 2-phase sinusoidal signals ST36D: 1Vp-p differential sinusoidal signals
Main scale grating pitch	8μm
Signal output pitch	4μm
Effective range	10 to 3000mm
Resolution	0.01, 0.02, 0.05, 0.1μm
Accuracy (20°C)*1	±0.5μm, ±1μm, ±2μm/m
Maximum response speed*2	1200mm/s
Scale reference point	Center point (10 to 80mm) 50mm pitch (100 to 3000mm)
Power supply voltage	DC5V ±5%
Operating temperature/humidity range	0 to 40°C/ 20 to 80% (no condensation)
Storage temperature/ humidity range	-20 to 60°C/ 20 to 80% (no condensation)
Head cable length	1m (high-flex connecting cable)

*1: Effective range	Accuracy
300mm or less	±0.5μm
500mm or less	±1μm
1000mm or less	±2μm
3000mm or less	±2μm/m

*2: Maximum response speed when the sinusoidal signals are output

- Any scale size drawings are available on request.

Mounting dimensions

• 10 to 80mm (Adhesive fixing type)

• 100 to 3000mm

Unit: mm

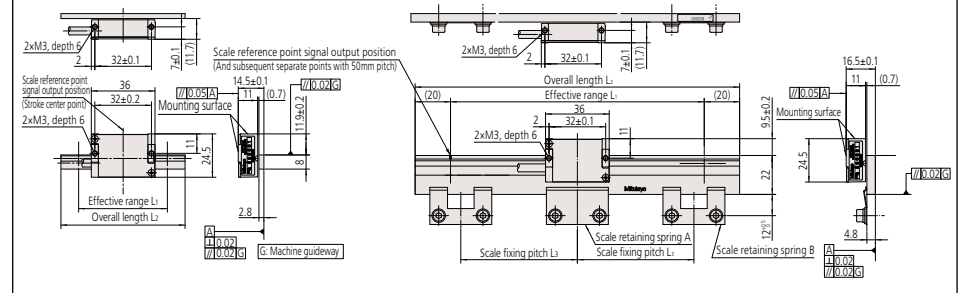

Dimensions of scale units

Order No.*	Code*	Effective range L1 (mm)	Overall length L2 (mm)	Scale fixing pitch L3 (mm)	Retaining spring A	Retaining spring B	Order No.*	Code*	Effective range L1 (mm)	Overall length L2 (mm)	Scale fixing pitch L3 (mm)	Retaining spring A	Retaining spring B
579-501-0	ST36◇10	10	30	—	—	—	579-518-0	ST36◇900	900	940	90	1 pc.	10 pcs.
579-502-0	ST36◇25	25	45	—	—	—	579-519-0	ST36◇1000	1000	1040	100	1 pc.	10 pcs.
579-503-0	ST36◇50	50	70	—	—	—	579-520-0	ST36◇1100	1100	1140	90	1 pc.	12 pcs.
579-504-0	ST36◇75	75	90	—	—	—	579-521-0	ST36◇1200	1200	1240	100	1 pc.	12 pcs.
579-505-0	ST36◇80	80	100	—	—	—	579-522-0	ST36◇1300	1300	1340	130	1 pc.	10 pcs.
579-506-0	ST36◇100	100	140	50	1 pc.	2 pcs.	579-523-0	ST36◇1400	1400	1440	100	1 pc.	14 pcs.
579-507-0	ST36◇150	150	190	75	1 pc.	2 pcs.	579-524-0	ST36◇1500	1500	1540	125	1 pc.	12 pcs.
579-508-0	ST36◇200	200	240	100	1 pc.	2 pcs.	579-525-0	ST36◇1600	1600	1640	100	1 pc.	16 pcs.
579-509-0	ST36◇250	250	290	60	1 pc.	4 pcs.	579-526-0	ST36◇1700	1700	1740	120	1 pc.	14 pcs.
579-510-0	ST36◇300	300	340	75	1 pc.	4 pcs.	579-527-0	ST36◇1800	1800	1840	100	1 pc.	18 pcs.
579-511-0	ST36◇350	350	390	85	1 pc.	4 pcs.	579-528-0	ST36◇2000	2000	2040	100	1 pc.	20 pcs.
579-512-0	ST36◇400	400	440	100	1 pc.	4 pcs.	579-529-0	ST36◇2200	2200	2240	100	1 pc.	22 pcs.
579-513-0	ST36◇450	450	490	75	1 pc.	6 pcs.	579-530-0	ST36◇2400	2400	2440	100	1 pc.	24 pcs.
579-514-0	ST36◇500	500	540	80	1 pc.	6 pcs.	579-531-0	ST36◇2500	2500	2540	95	1 pc.	26 pcs.
579-515-0	ST36◇600	600	640	100	1 pc.	6 pcs.	579-532-0	ST36◇2600	2600	2640	100	1 pc.	26 pcs.
579-516-0	ST36◇700	700	740	85	1 pc.	8 pcs.	579-533-0	ST36◇2800	2800	2840	100	1 pc.	28 pcs.
579-517-0	ST36◇800	800	840	100	1 pc.	8 pcs.	579-534-0	ST36◇3000	3000	3040	100	1 pc.	30 pcs.

* The above code numbers are for recommended items marked with ● / ○ symbols. If recommended specifications meet your requirements, use these code numbers to order.

* The □ and ◇ symbols in the tables above have the following meanings:
 ◇→A (2-phase sinusoidal signals): □→1
 ◇→B (2-phase square wave signals + reset input): □→2
 ◇→C (2-phase sinusoidal signals + 2-phase square wave signals): □→3
 ◇→D (1Vp-p differential): □→4

Fiber Scale ST-F11

SERIES 579 — Ultra Compact Linear Scale

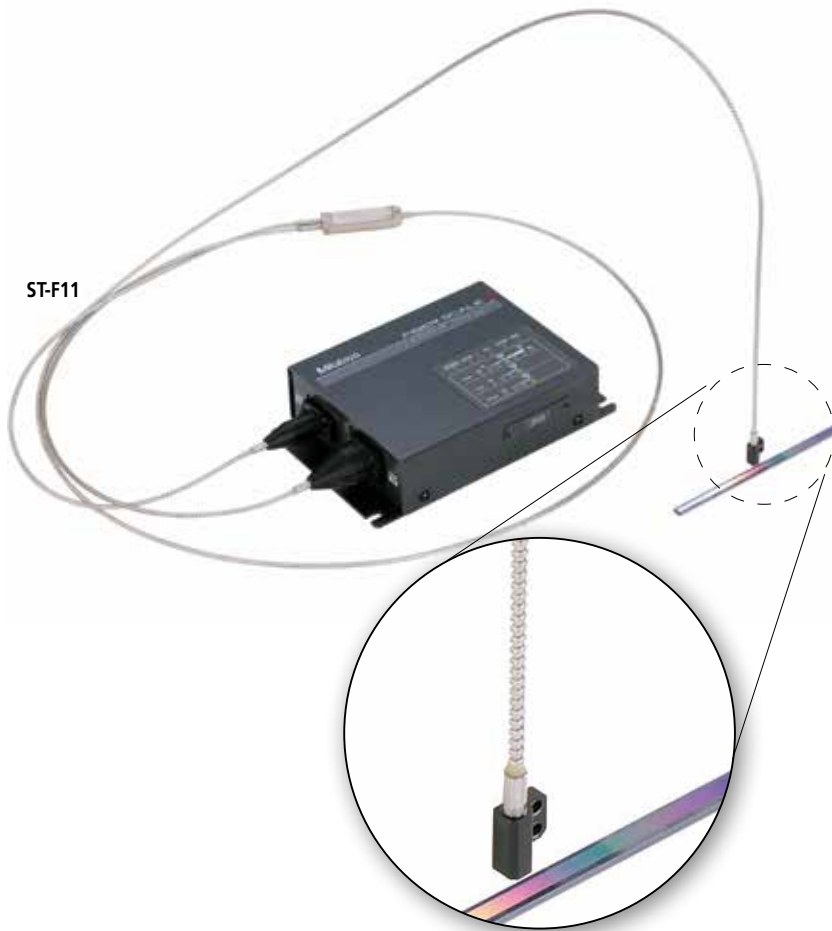

FEATURES

- Ultra-compact detector head: 5mm width (S-Type)
- High resolution: 100 nm (0.1 μ m), 50 nm (0.05 μ m), 10 nm (0.01 μ m)
- Isolated heat source. No heat source at the detector head.
- Immune to EMI.
- Easy installation. LEDs on the processor indicate which direction to adjust the detector head when mounting.

Processor LED Indicators



SPECIFICATIONS

Model	ST- F11B	ST- F11C
Detection method	Diffraction interference , reflection-type linear encoder	
Grating pitch for the main scale	4 μ m	
Signal output pitch	2 μ m	
Output signal	2-phase-shifted square wave (+ reset input)	2-phase-shifted square wave 2-phase-shifted sine wave
Resolution	10 nm / 50 nm / 100 nm (switchable)	
Effective length	4" / 100 mm	
Accuracy at 20°C	$\pm 1 \mu$ m, $\pm 2 \mu$ m (custom-holder type)	
Maximum response speed	800 mm/s (For the sine wave)	
Read head size (Selectable)	Perpendicular (S-Type) 5x9.6x12 Parallel (L-Type) 6x17x10	
Main scale material (Selectable)	Quartz glass (expansion coefficient: 0.5×10^{-6}) (LTE) Low thermal expansion glass (expansion coefficient: $0 \pm 0.02 \times 10^{-6}$)	
Fiber length (Selectable)	2, 3, 5, 10 m (20, 30m: custom-order)	
Maximum consumption current / operating voltage	350 mA / DC5V \pm 5%	
Operating temperature and humidity	0~40°C 20~80%RH (no condensation)	
Storage temperature and humidity	-20~60°C 20~80%RH (no condensation)	
Functions	Alarm output, read-head attitude confirmation, signal-confirmation function	

- Any scale size drawings are available on request.

Fiber Scale ST-F11

SERIES 579 — Ultra Compact Linear Scale

Dimensions of Processor

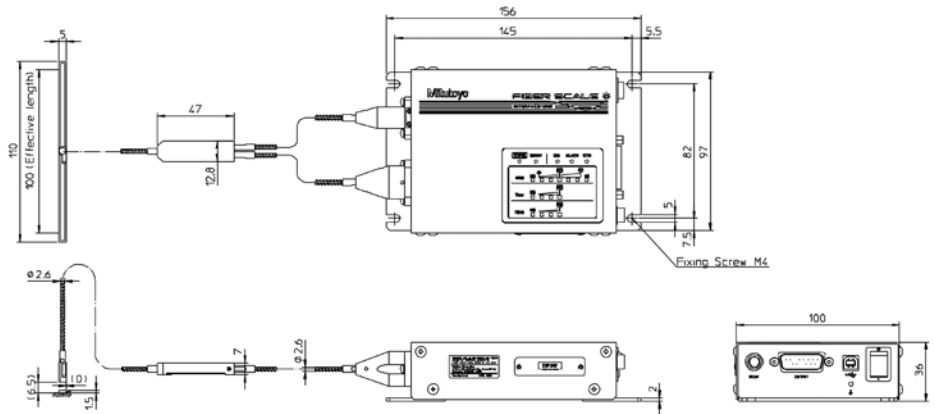

Dimensions of Detector Heads

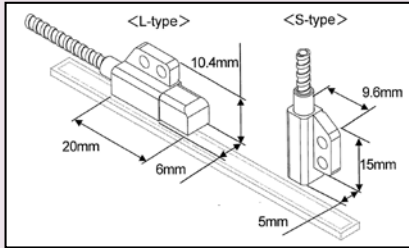

SPECIFICATIONS

Order Number	Model Number	Output Signal	Scale Material	Detector Orientation to Scale	Fiber Length
579-701-11	ST-F11B-100A-S02	2 Phase Square	Quartz Glass	Parallel	2m
579-702-11	ST-F11B-100A-S03	2 Phase Square	Quartz Glass	Parallel	3m
579-703-11	ST-F11B-100A-S05	2 Phase Square	Quartz Glass	Parallel	5m
579-704-11	ST-F11B-100A-S10	2 Phase Square	Quartz Glass	Parallel	10m
579-701-12	ST-F11B-100B-S02	2 Phase Square	LTE Glass	Parallel	2m
579-702-12	ST-F11B-100B-S03	2 Phase Square	LTE Glass	Parallel	3m
579-703-12	ST-F11B-100B-S05	2 Phase Square	LTE Glass	Parallel	5m
579-704-12	ST-F11B-100B-S10	2 Phase Square	LTE Glass	Parallel	10m
579-701-21	ST-F11C-100A-S02	2 Phase Square / 2 phase sine	Quartz Glass	Parallel	2m
579-702-21	ST-F11C-100A-S03	2 Phase Square / 2 phase sine	Quartz Glass	Parallel	3m
579-703-21	ST-F11C-100A-S05	2 Phase Square / 2 phase sine	Quartz Glass	Parallel	5m
579-704-21	ST-F11C-100A-S10	2 Phase Square / 2 phase sine	Quartz Glass	Parallel	10m
579-701-22	ST-F11C-100B-S02	2 Phase Square / 2 phase sine	LTE Glass	Parallel	2m
579-702-22	ST-F11C-100B-S03	2 Phase Square / 2 phase sine	LTE Glass	Parallel	3m
579-703-22	ST-F11C-100B-S05	2 Phase Square / 2 phase sine	LTE Glass	Parallel	5m
579-704-22	ST-F11C-100B-S10	2 Phase Square / 2 phase sine	LTE Glass	Parallel	10m
579-711-11	ST-F11B-100A-L02	2 Phase Square	Quartz Glass	Perpendicular	2m
579-712-11	ST-F11B-100A-L03	2 Phase Square	Quartz Glass	Perpendicular	3m
579-713-11	ST-F11B-100A-L05	2 Phase Square	Quartz Glass	Perpendicular	5m
579-714-11	ST-F11B-100A-L10	2 Phase Square	Quartz Glass	Perpendicular	10m
579-711-12	ST-F11B-100B-L02	2 Phase Square	LTE Glass	Perpendicular	2m
579-712-12	ST-F11B-100B-L03	2 Phase Square	LTE Glass	Perpendicular	3m
579-713-12	ST-F11B-100B-L05	2 Phase Square	LTE Glass	Perpendicular	5m
579-714-12	ST-F11B-100B-L10	2 Phase Square	LTE Glass	Perpendicular	10m
579-711-21	ST-F11C-100A-L02	2 Phase Square / 2 phase sine	Quartz Glass	Perpendicular	2m
579-712-21	ST-F11C-100A-L03	2 Phase Square / 2 phase sine	Quartz Glass	Perpendicular	3m
579-713-21	ST-F11C-100A-L05	2 Phase Square / 2 phase sine	Quartz Glass	Perpendicular	5m
579-714-21	ST-F11C-100A-L10	2 Phase Square / 2 phase sine	Quartz Glass	Perpendicular	10m
579-711-22	ST-F11C-100B-L02	2 Phase Square / 2 phase sine	LTE Glass	Perpendicular	2m
579-712-22	ST-F11C-100B-L03	2 Phase Square / 2 phase sine	LTE Glass	Perpendicular	3m
579-713-22	ST-F11C-100B-L05	2 Phase Square / 2 phase sine	LTE Glass	Perpendicular	5m
579-714-22	ST-F11C-100B-L10	2 Phase Square / 2 phase sine	LTE Glass	Perpendicular	10m

Pulse Signal Interface Unit PSU-200

SERIES 539

- The **PSU-200** splits the sinusoidal signal output by Mitutoyo linear scales into a minimum of four and a maximum of 200 divisions, and converts the signal to a square-wave signal so that NC feedback systems, measurement control devices, etc., can be used with linear scales in order to achieve highly accurate positioning.



SPECIFICATIONS

Order No.	539-005
Model	PSU-200
Number of axes	1 axis
Input	Input connector: DA-15S-N (JAE) or equivalent Input signal: 2-phase sinusoidal and the reference voltage, reference point, scale alarm
Output	Output connector: MR-20RMA (HONDA TSUSHIN KOGYO CO., LTD.) Output signal: 2-phase square wave signals (PA, PB), reference point (PZ), alarm, alarm reset, photo-coupler
Number of splits	4, 8, 10, 20, 40, 80, 100, 200 (Selectable with the switch)
Function	Setting the number of slits, setting the minimum edge interval, and maximum response speed. Detection of broken wires or short circuits and abnormalities (alarm), detection of signal errors (alarm). Power supply voltage low-alarm (warning light only), switching between high-impedance mode and alarm-signal output mode. Reference position detection light, hysteresis width settings (directly linked to No. of divisions), external alarm reset input (photocoupler), switching directions
Power supply voltage	5VDC \pm 5%
Current consumption	200mA
Storage temperature range	-20°C to 70°C
Operating temperature range	0°C to 40°C
Dimensions	160(W) \times 100(D) \times 28(H)mm
Mass	Approx. 620g

System configuration

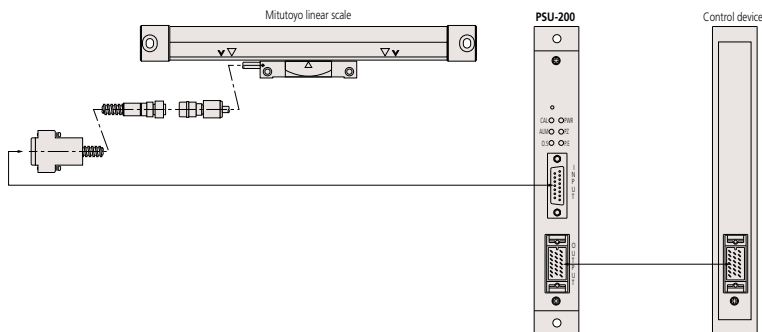

DIMENSIONS

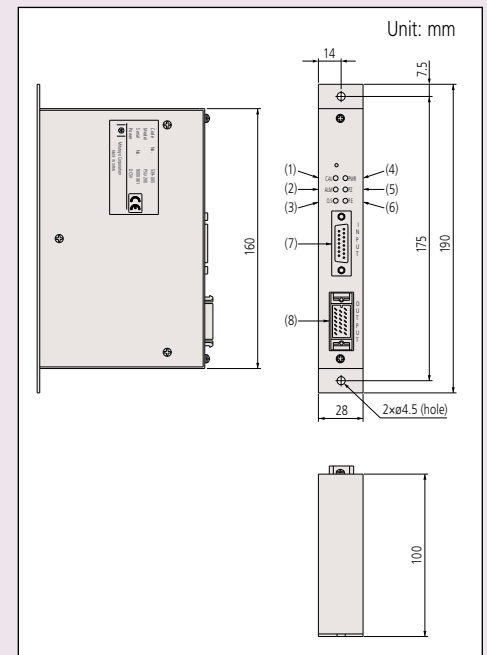

Signal Conversion Adapter PSU-400E

SERIES 539 — Interface Unit (Optional accessories)



FEATURES

- The PSU-400E series interface unit converts the 1Vp-p differential signal output by AT402E, so that NC feedback systems or measurement control devices can be used with linear scales in order to achieve highly accurate positioning.
- PSU-400EA interface unit converts the 1Vp-p differential signal output by AT402E to the 11 μ A differential signal.
- PSU-400EV interface unit splits the 1Vp-p differential signal output by AT402E into a minimum of 20 and a maximum of 4000 divisions, and converts the signal to a square wave.

SPECIFICATIONS

Order No. Items	539-008 PSU-400EA	539-009 PSU-400EV
Input signal	1Vpp differential Sinusoidal signal (AT402E)	
Output signal	11 μ A sine wave signal	TTL signal (RS422)
Output signal: Division number (Resolution)	—	TTL X5 (1 μ m), TTL X10 (0.5 μ m), TTL X20 (0.25 μ m), TTL X25 (0.2 μ m), TTL X50 (0.1 μ m), TTL X100 (0.05 μ m), TTL X250 (0.1 μ m), TTL X500 (0.01 μ m), TTL X1000 (0.005 μ m)
Minimum edge intervals	—	62.5, 125, 250, 500, 1000, 2000 [ns]
Maximum current consumption	60mA	130mA
Power supply	DC5V \pm 5%	
Storage temperature	-20 to 70°C 20 to 80%RH	
Operating temperature	0 to 50°C 20 to 80%RH	
External dimension	80(W) \times 40(D) \times 20(H)	
Status LED	Simple error display (without error output)	Error display (with error output)
Response speed	120m/min (100kHz)	It depends on number of interpolation and minimum edge intervals (Max: 100kHz)

TIP: Signal cable Type B is connectable.

DIMENSIONS

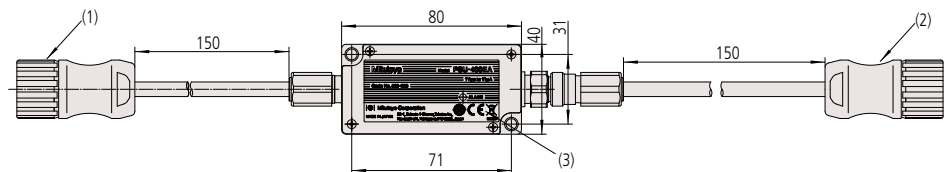

No.	Name	
(1)	INPUT connector	Connector for connecting with Linear Scale AT402E
(2)	OUTPUT connector	Connector for connecting with external device
(3)	ALM lamp	Lights red when alarming (Normally lights green)

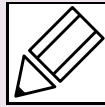

Tests for Evaluating Linear Scales

1. Testing within the service temperature range

Confirms that there is no performance abnormality of a unit within the service temperature range and that data output is according to the standard.

2. Temperature cycle (dynamic characteristics) test

Confirms that there is no performance abnormality of a unit during temperature cycling while operating and that data output is according to the standard.

3. Vibration test (Sweep test)

Confirms that there is no performance abnormality of a unit while subject to vibrations of a frequency ranging from 30Hz to 300Hz with a maximum acceleration of 29.42m/s^2 .

4. Vibration test (Acceleration test)

Confirms that there is no performance abnormality of a unit subject to vibrations at a specific, non-resonant frequency. (Approx. 98.07m/s^2)

5. Noise test

The noise test conforms to EMC Directive EN61326-1+A1:1998.

6. Package drop test

This test conforms to JIS Z 0200 (Heavy duty material drop test)

Glossary

■ Absolute system

A measurement mode in which every point measurement is made relative to a fixed origin point.

■ Incremental system

A measurement mode in which every point measurement is made relative to a certain stored reference point.

■ Origin offset

A function that enables the origin point of a coordinate system to be translated to another point offset from the fixed origin point. For this function to work, a system needs a permanently stored origin point.

■ Restoring the origin point

A function that stops each axis of a machine accurately in position specific to the machine while slowing it with the aid of integrated limit switches.

■ Sequence control

A type of control that sequentially performs control steps according to a prescribed order.

■ Numerical control

A way of controlling the movements of a machine by encoded commands created and implemented with the aid of a computer (CNC). A sequence of commands typically forms a 'part program' that instructs a machine to perform a complete operation on a workpiece.

■ Binary output

Refers to output of data in binary form (ones and zeros) that represent numbers as integer powers of 2.

■ RS-232C

An interface standard that uses an asynchronous method of serial transmission of data over an unbalanced transmission line for data exchange between transmitters located relatively close to each other. It is a means of communication mainly used for connecting a personal computer with peripherals.

■ Line driver output

This output features fast operating speeds of several tens to several hundreds of nanoseconds and a relatively long transmission distance of several hundreds of meters. A differential-voltmeter line driver (RS422A compatible) is used as an I/F to the NC controller in the linear scale system.

■ BCD

A notation of expressing the numerals 0 through 9 for each digit of a decimal number by means of four-bit binary sequence. Data transmission is one-way output by means of TTL or open collector.

■ RS-422

An interface standard that uses serial transmission of bits in differential form over a balanced transmission line. RS-422 is superior in its data transmission characteristics and in its capability of operating with only a single power supply of +5V.

■ Accuracy

The accuracy specification of a scale is given in terms of the maximum error to be expected between the indicated and true positions at any point, within the range of that scale, at a temperature of 20°C . Since there is no international standard defined for scale units, each manufacturer has a specific way of specifying accuracy. The accuracy specifications given in our catalog have been determined using laser interferometry.

■ Narrow range accuracy

Scale gratings on a scale unit normally adopt $20\mu\text{m}$ pitch though it varies according to the kind of scale. The narrow range accuracy refers to the accuracy determined by measuring one pitch of each grating at the limit of resolution ($1\mu\text{m}$ for example).

Principle of the Absolute Linear Scale (Example: ABS AT300, 500-S/H)

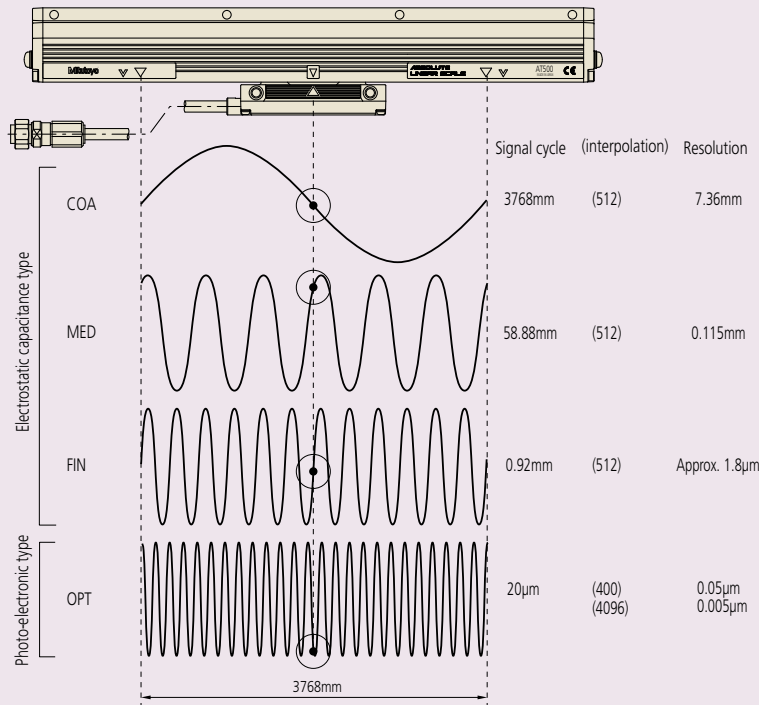

Upon supply of power to a linear scale, position readings from three capacitance-type sub-scales (COArse, MEDium and FINE) and one from a photoelectric sub-scale (OPTical) are taken. These sub-scales use such a combination of pitches, and are so positioned relative to each other, that the readings at any one position form a unique set and allow a microprocessor to calculate the position of the read head on the scale to a resolution of 0.05µm (0.005µm).

Specifying Linear Scale Accuracy

Positional Indication accuracy

The accuracy of a linear scale is determined by comparing the positional value indicated by the linear scale with the corresponding value from a laser length measuring machine at regular intervals using the accuracy inspection system as shown in the figure below. As the temperature of the inspection environment is 20°C, the accuracy of the scale applies only in an environment at this temperature. Other inspection temperatures may be used to comply with internal standards.

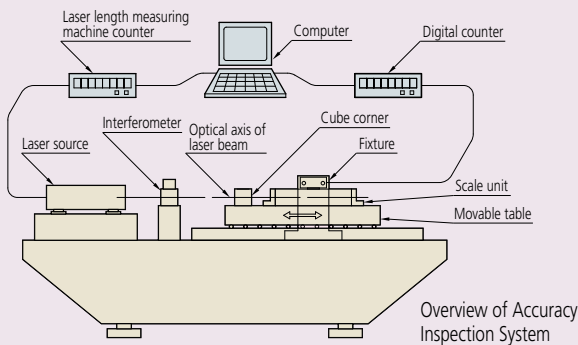

The accuracy of the scale at each point is defined in terms of an error value that is calculated using the following formula:

$$\text{Error} = \text{Value indicated by laser inspection system} - \text{Corresponding value indicated by the linear scale}$$

A graph in which the error at each point in the effective positioning range is plotted is called an accuracy diagram. There are two methods used to specify the accuracy of a scale, unbalanced or balanced, described below.

(1) Unbalanced accuracy specification - maximum minus minimum error

This method simply specifies the maximum error minus the minimum error from the accuracy graph, as shown below. It is of the form: $E = (\alpha + \beta L)\mu\text{m}$. L is the effective range (mm), and α and β are factors specified for each model.

For example, if a particular type of scale has an accuracy specification of $(3 + \frac{3L}{1000})\mu\text{m}$ and an effective range of 1000mm, E is 6µm.

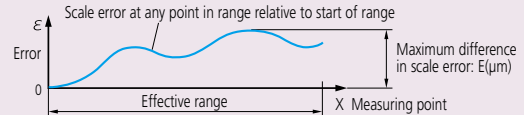

(2) Balanced accuracy specification - plus and minus about the mean error

This method specifies the maximum error relative to the mean error from the accuracy graph. It is of the form: $e = \pm \frac{E}{2} (\mu\text{m})$. This is mainly used in separate-type (retrofit) scale unit specifications.

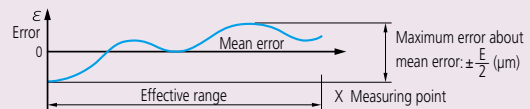

A linear scale detects displacement based on graduations of constant pitch. Two-phase sinusoidal signals with the same pitch as the graduations are obtained by detecting the graduations. Interpolating these signals in the electrical circuit makes it possible to read a value smaller than the graduations by generating pulse signals that correspond to the desired resolution. For example, if the graduation pitch is 20µm, interpolated values can generate a resolution of 1µm. The accuracy of this processing is not error-free and is called interpolation accuracy. The linear scale's overall positional accuracy specification depends both on the pitch error of the graduations and interpolation accuracy.

MITUTOYO CUSTOM SOLUTIONS

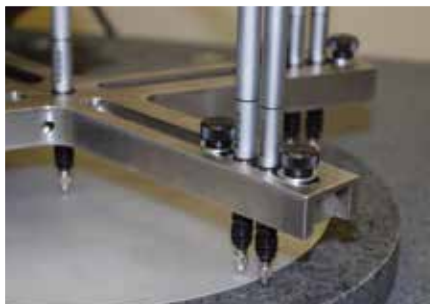
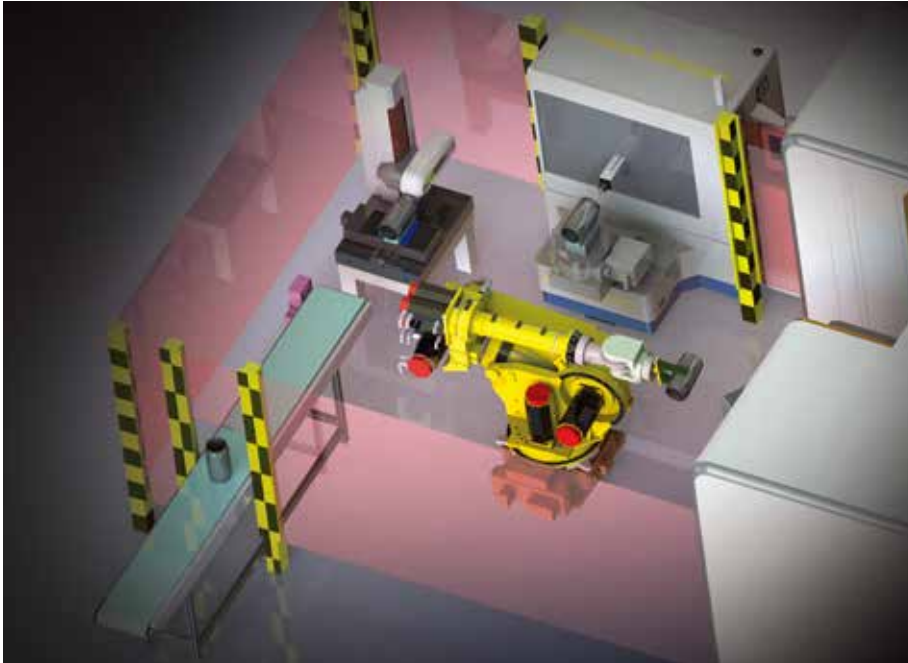

Mitutoyo Custom Solutions helps businesses in a wide range of industries achieve higher quality products, parts and machines with custom precision measurement tools and equipment.

Mitutoyo's highly skilled engineers specialize in designing and building custom measurement systems, applications and software to bring value-added solutions to resolve nearly every measurement need for customers with unique applications.

Custom Solutions & Services Include:

- Inline/near line part inspection and gaging
- Factory automation
- Data management
- Fixture design/build
- 3D CAD concepts/renderings
- Turnkey capital projects
- Product implementation
- Custom styli/accessories
- "Green button" technology

If you have any questions or would like more information regarding Mitutoyo Custom Solutions, contact: solutions@mitutoyo.com