

Mitutoyo

Mitutoyo Quality

CONTOUR MEASURING SYSTEMS CONTRACER CV-3200/4500 SERIES

High-accuracy contour measuring machine with
exciting new features

FORM MEASUREMENT



Bulletin No. 2177(3)

CONTRACER CV-4500 Series

Continuous top-bottom measurement function for easy measurement of upper and lower surfaces

Upper and lower surfaces can be measured continuously by using Mitutoyo's double-sided conical stylus.

This continuous measurement data can be used to facilitate analysis of features that were difficult to measure before, such as the effective diameter of an internal screw-thread.

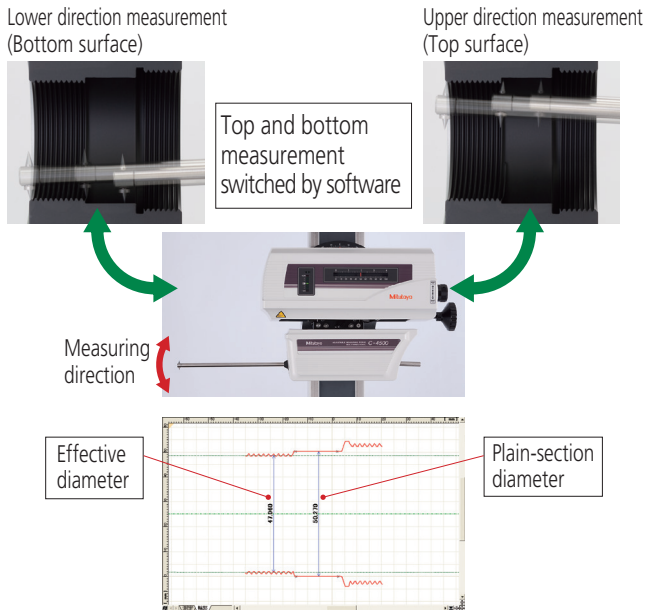

Continuous top-bottom measurement allows hassle-free one-step calibration

(Patent pending in Japan)

The one-step calibration kit supplied with the CV-4500 Series has been upgraded to enable easy calibration of the double-ended conical stylus featuring a contact on both the top and the bottom. Precise work such as calibrating the Z1-axis gain, symmetry, and stylus radius can now be carried out in a single operation.

- Calibration kit for CV-4500series

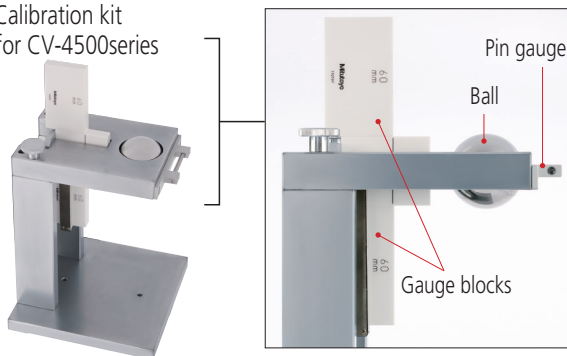

Variable measuring force function

The measuring force can be varied in 5 steps by using the software provided (**FORMTRACEPAK**), eliminating the need to adjust the measuring force by switching weights or through positional adjustment.

The CV-4500 Series can also maintain the specified measuring force even when tilted.

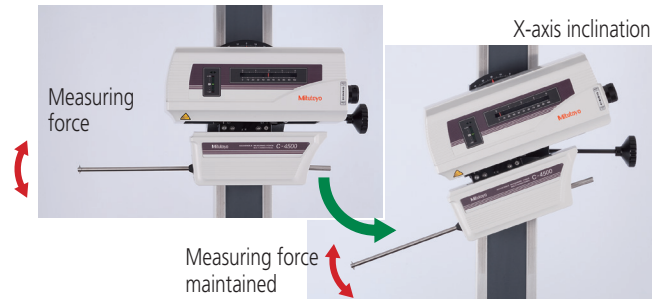

Best-in-class displacement accuracy

The CV-4500 Series features a built-in precision arc scale on the Z1 axis (detector) that allows the arc trajectory of the stylus tip to be read directly, minimizing the detector mechanism error and enabling precision, high-resolution measurement. On the X axis (driver) is a linear scale, allowing high-accuracy full-stroke measurement.

Accuracy

$$\begin{aligned} \text{Z1 axis (detector unit): } & \pm (0.8 + |2H| / 100) \mu\text{m} \\ & H = \text{Measurement height from the horizontal position (mm)} \\ \text{X axis (drive unit): } & \pm (0.8 + 0.01L) \mu\text{m}^*1 \\ & L = \text{drive length (mm)} \end{aligned}$$

Resolution

$$\begin{aligned} \text{Z1 axis (detector unit) : } & 0.02\mu\text{m} \\ \text{X axis (drive unit) : } & 0.05\mu\text{m} \end{aligned}$$

*1 These specifications apply to the CV-4500S4/H4/W4. For specifications of other products in the series, see Specifications on page 14.

Fast traverse improves measurement efficiency

$$\begin{aligned} \text{X axis (drive unit) : } & 80\text{mm/s (MAX)} \\ \text{Z2 axis (column) : } & 30\text{mm/s (MAX)} \end{aligned}$$

The total measurement time can be shortened by speeding up the traverse movements.

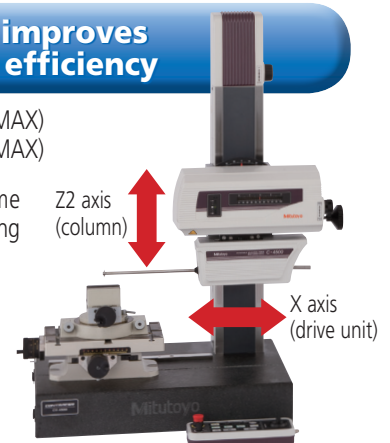

New top-bottom continuous measurement and variable measuring force enable efficient, highly accurate measurement of a wide range of objects.

Detector with new arm design

Mitutoyo's newly designed detector arm lowers workpiece interference while expanding the measurement range in the Z1 axis (detector).

- When using the SPH-71 one-sided cut stylus

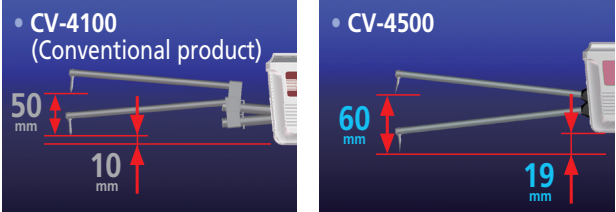

Detector measurement range expanded by 10 mm

One-touch arm attachment (Patent pending in Japan)

The arm mount uses a magnetic joint for quick and easy arm replacement. The mount also includes a safety mechanism.

- CV-4100 (Conventional product)

- CV-4500

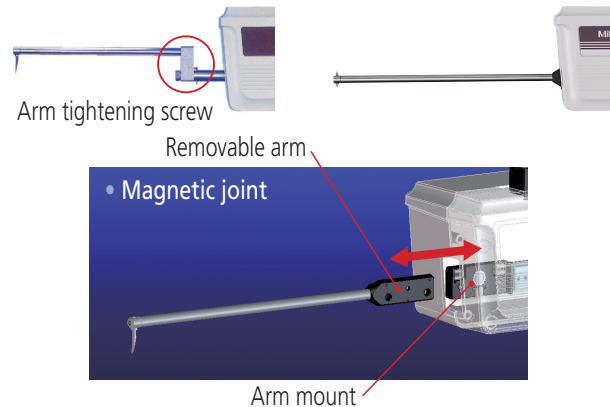

All detector and drive unit cables are housed inside the main unit to eliminate any risk of abrasion and guarantee trouble free, high-speed operation.

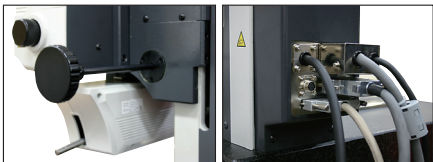

Auto stop feature assures safety even during high-speed movement

The detector includes a safety mechanism (auto stop upon collision) to assure measurement safety even during high-speed movement. If the arm is removed or shifts during measurement, the safety mechanism is triggered and stops the machine.

- Direction of collision that may cause the safety device to be triggered

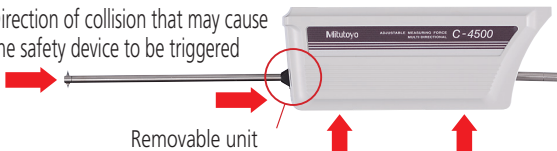

Excellent operability

Remote-control unit enables safe, easy & fast measurement

The remote-control unit lets you move quickly from positioning to measurement. The unit also features an emergency stop switch and speed control knob for added safety while the machine is moving at high speeds.



Remarkable Ease of Operation

Incorporation of an ABS scale in the Z2 axis eliminates the need for wearisome origin point re-setting conventionally required for every step of repeated measurements over stepped or multiple sections.

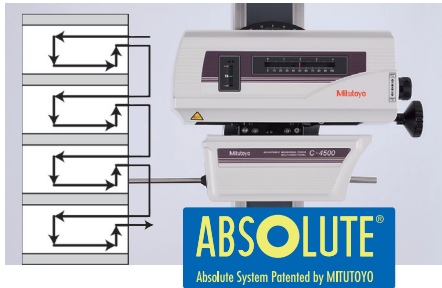

Simple positioning by fine feed mechanisms

Small holes and inclined planes can be efficiently measured using the inclined X-axis drive unit and fine-feed handles on the X and Z2 axes.

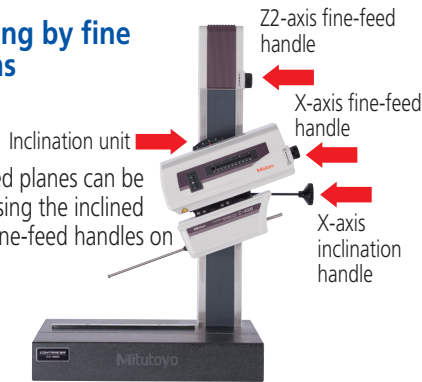

Simplified CNC Function

With the support for a wide range of optional peripherals designed for use with the CNC Form Measuring Unit enables simplified CNC measurement.

- Ø1-axis Rotary unit: Automatic circular-form measurement

- Ø2-axis Rotary unit: Automatic multiple-section continuous measurement

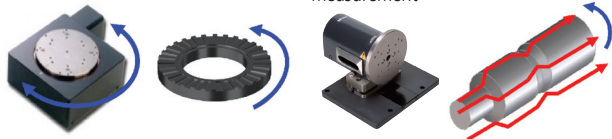

CONTRACER CV-3200 Series

Detector with new arm design

Mitutoyo's newly designed detector arm lowers workpiece interference while expanding the measurement range in the Z1 axis (detector).

- When using the SPH-71 one-sided cut stylus



Detector measurement range expanded by 10 mm

One-touch arm attachment (Patent pending in Japan)

The arm mount uses a magnetic joint for quick and easy arm replacement. The mount also includes a safety mechanism.

- CV-3100 (Conventional product) • CV-3200



Arm tightening screw

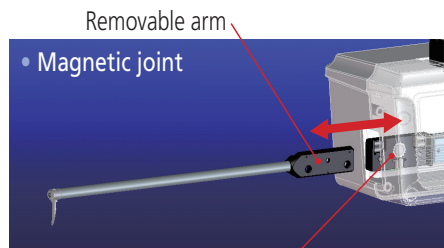

- Magnetic joint

Arm mount

All detector and drive unit cables are housed inside the main unit to eliminate any risk of abrasion and guarantee trouble free, high-speed operation.

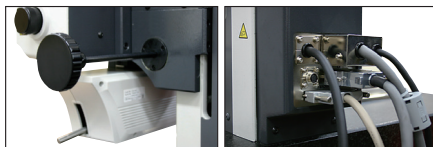

Auto stop feature assures safety even during high-speed movement

The detector includes a safety mechanism (auto stop upon collision) to assure measurement safety even during high-speed movement. If the arm is removed or shifts during measurement, the safety mechanism is triggered and stops the machine.

- Direction of collision that may cause the safety device to be triggered

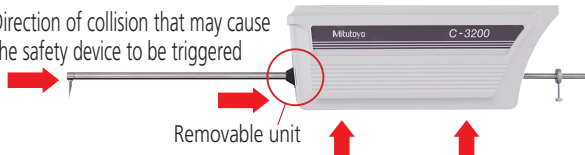

Removable unit



Hassle-free one-step calibration

The CV-3200 Series provides a dedicated calibration gage that lets you carry out precise work such as calibrating the Z1-axis gain, symmetry, and stylus radius in a single operation. Calibration of upward measurement is also possible by using Mitutoyo's optional calibration stage.

- Calibration kit for CV-3200 series

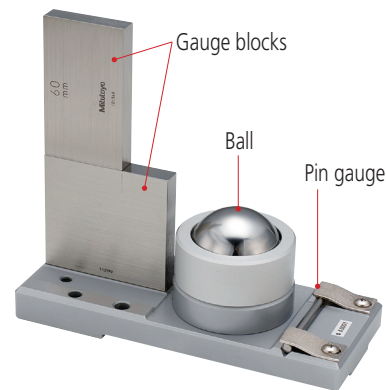

Gauge blocks

Ball

Pin gauge

Best-in-class displacement accuracy

The CV-3200 Series features a built-in precision arc scale on the Z1 axis (detector) that allows the arc trajectory of the stylus tip to be read directly, minimizing the detector mechanism error and enabling precision, high-resolution measurement. On the X axis (driver) is a linear scale, allowing high-accuracy full-stroke measurement.

Accuracy _____

Z1 axis (detector unit): $\pm (1.4 + |2H| / 100) \mu\text{m}$
H = Measurement height from the horizontal position (mm)

X axis (drive unit): $\pm (0.8 + 0.01L) \mu\text{m}^{*1}$
L = drive length (mm)

Resolution _____

Z1 axis (detector unit): 0.04 μm

X axis (drive unit): 0.05 μm

*1 These specifications apply to the CV-3200S4/H4/W4. For specifications of other products in the series, see Specifications on page 14.

Best-in-class accuracy, high-speed movement, and new detector arm design enable hassle-free, highly accurate measurement.

Excellent operability

Remote-control unit enables safe, easy & fast measurement

The remote-control unit lets you move quickly from positioning to measurement. The unit also features an emergency stop switch and speed control knob for added safety while the machine is moving at high speeds.



Remarkable Ease of Operation

Incorporation of an ABS scale in the Z2 axis eliminates the need for wearisome origin point re-setting conventionally required for every step of repeated measurements over stepped or multiple sections.

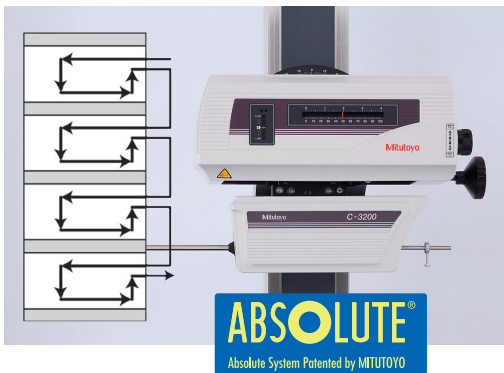

Simple positioning by fine feed mechanisms

Small holes and inclined planes can be efficiently measured using the inclined X-axis drive unit and fine-feed handles on the X and Z2 axes.

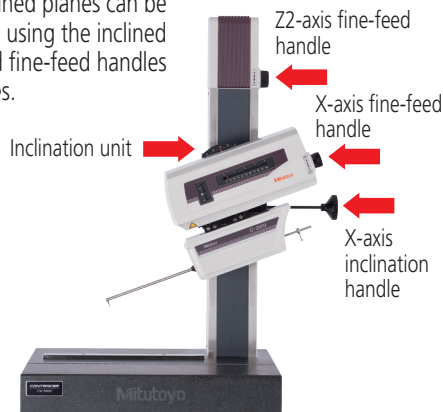

Fast movement improves measurement efficiency

X axis (drive unit) : 80mm/s (MAX)
Z2 axis (column) : 30mm/s (MAX)

The total measurement time can be shortened by speeding up the movement.

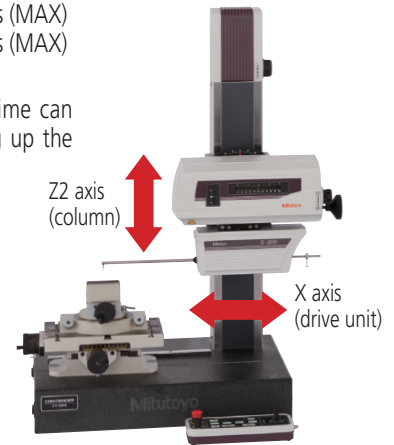

Simplified CNC Function

With the support for a wide range of optional peripherals designed for use with the CNC Form Measuring Unit enables simplified CNC measurement.

- $\Theta 1$ -axis Rotary unit: Automatic circular-form measurement



- $\Theta 2$ -axis Rotary unit: Automatic multiple-section continuous measurement

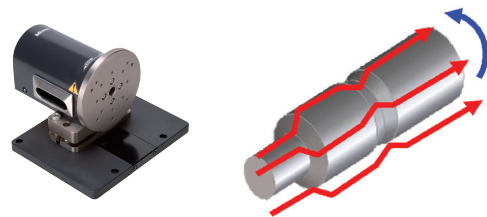

Contour Analysis Software: FORMTRACEPAK

FORMTRACEPAK functions offer total support for measurement system control, surface roughness analysis, contour analysis, contour tolerancing, and inspection report creation.

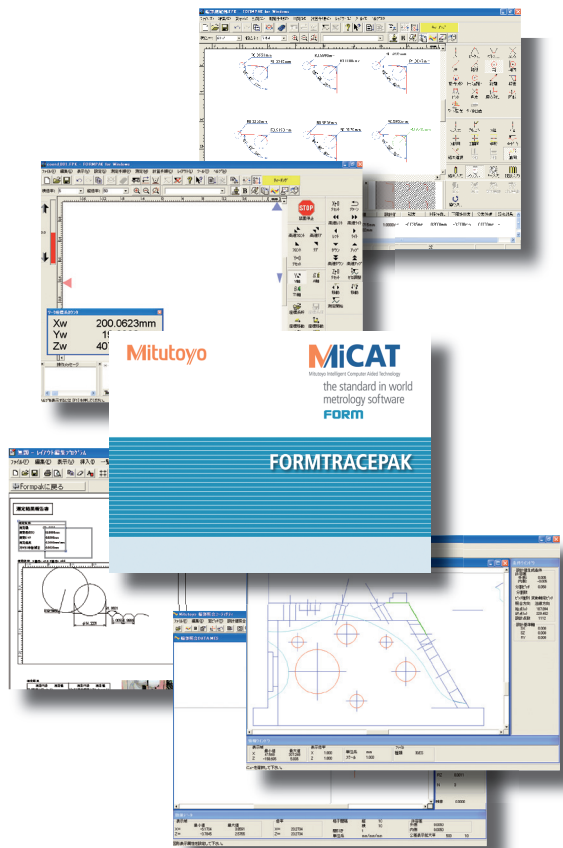

Measurement control

To make only a single measurement, you can create a part program in the single mode. To measure multiple workpieces of an identical shape, you can use the teaching mode.

FORMTRACEPAK supports the new top-bottom continuous measurement and variable measuring force functions of the CV-4500 Series (see page 2 for details), providing an even higher level of usability. Since you can embed the entire flow, from making measurement to printing a report, into a part program, you can efficiently make measurements, analyze data, and output a report. A function is also provided that enables you to insert comments accompanied with photographs at desired timings, enabling you to embed the roles described in a measurement procedure document that specifies important points such as work settings.

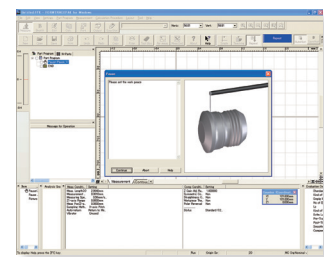

To make immediate measurements, you can use the pull-down menu to easily select and call up the desired operating procedure.

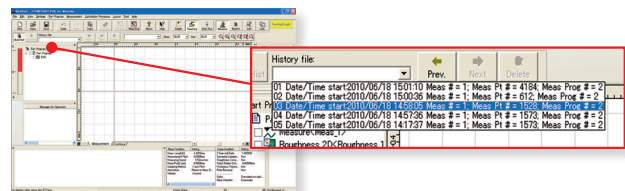

Multiple language support (15 languages)

You can switch the language* to be used in the measurement, analysis, and layout windows.

After measurements have been made, you can switch to another language and create a report in that language. This function can be used worldwide.

* Supported languages: Japanese, English, German, French, Italian, Spanish, Polish, Hungarian, Swedish, Czech, Simplified Chinese, Traditional Chinese, Korean, Turkish, Portuguese.

Online help function*

Online help that can be viewed any time is incorporated into the software. In addition to index and keyword searches, a status saving help button, which displays menus and Windows help with a click of the mouse, is provided.

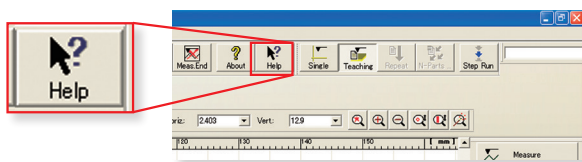

* Online help function supports only Japanese and English.

Button-editing function

You can hide buttons that are not used frequently. For example, you can choose to display only those buttons that are used frequently and increase the size of the displayed graphics window, thereby customizing the window to suit your needs.

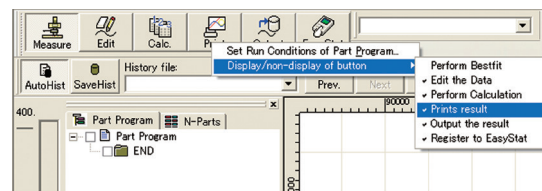

Simple statistical commands

You can perform statistical calculations of roughness parameters and contour analysis results without using a separate program such as Excel.

Contour Analysis

Contour analysis function

A wide variety of commands, which form the basic elements for analysis, are provided, including those for points (10 kinds), lines (6 kinds), and circles (6 kinds). A rich set of commands that combine these elements to calculate angles, pitches, and distances, a contour tolerancing function, and a design value generation function are also provided as standard features. These functions, combined with the function that allows you to customize the calculation command buttons by hiding less frequently used commands, let you tailor the window according to the user environment.

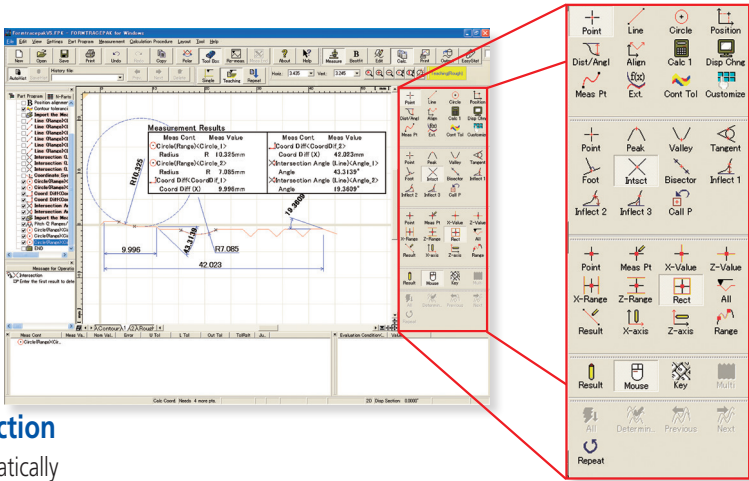

Circle and line automatic determination function

Using the circle/line auto-fitting command, you can automatically calculate all circles and lines contained in the data without having to click the command button each time.

Removal of abnormal points function

Irregular defects in the data are filtered out from the calculation. This function is effective when specifying the calculation range for locations at which the boundary between circle and line is difficult to determine.

Text output of the calculation result and graphics data

You can output the calculation result as text (in csv or txt format), output graphics data obtained from measurements as point-string data to a text file or CAD file (in the DXF or IGES format), or copy the data to the clipboard. Combined with commercial document or statistical processing software, this feature can be used to share data with computers that do not have dedicated analysis software installed or execute CAD-based reverse engineering.

Simple pitch calculation function

You can efficiently analyze the pitch between identical shapes, such as a screw pitch or the distance between circles (center-to-center pitch), by simply specifying the desired range using mouse operations.

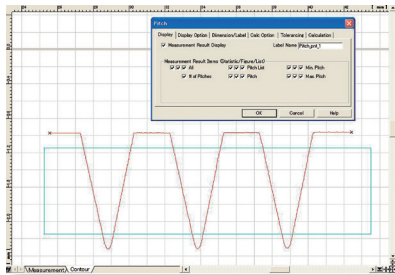

Example of range specification for screw thread pitch with rectangular tool.

Contour-tolerancing function as a standard feature

The best-fit processing function that moves the coordinate values of the design data and measurement data to the optimum positions is provided as a standard feature. Since the tolerancing results can be visually displayed as graphics, displayed as tolerance values and tolerance expansions in each coordinate, or output as a text file, they can be utilized as feedback data for machining systems.

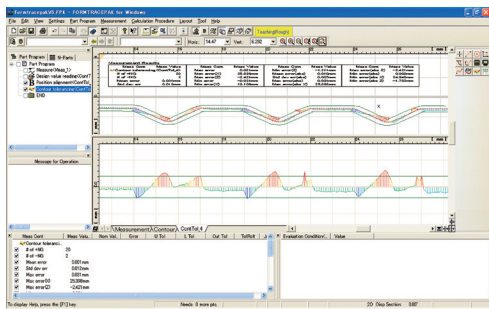

Example of contour-tolerancing result

UNIT:MM	MUNE-ROTZ	SIFT	TRANSIFT	ROZ	TWT	LTYP-FIURE	TLE	WTL	USE-FRE
	0.00	0.000, 0.000	0.000, 0.000	0.000, 0.000	1.000, -0.000	0.000, 1.000	0.000, 0.000	0.000, 0.000	
NAME:193									
NO	NOMINAL POINT(X,Y)	NORMAL VECTOR	ERRER	RESULT					
1	12.254, -1.085	-0.070 -0.997	-0.005	21/IN					
2	12.454, -1.084	-0.015 -1.000	-0.004	21/IN					
3	12.554, -1.085	-0.082 -0.997	-0.004	21/IN					
4	12.654, -1.086	-0.043 -0.999	-0.004	21/IN					
5	12.754, -1.086	0.022 -0.999	-0.004	21/IN					
6	12.854, -1.087	0.057 -0.998	-0.004	21/IN					
7	12.954, -1.088	0.020 -1.000	-0.004	21/IN					
8	13.054, -1.088	0.000 -0.999	-0.005	22/IN					
9	13.154, -1.089	-0.039 -0.999	-0.004	21/IN					

Example of contour tolerancing results output as numeric values

Contour Analysis Software: FORMTRACEPAK

MiCAT

Mitutoyo Intelligent Computer Aided Technology

the standard in world
metrology software

FORM

Contour Analysis

Design value generation function

You can generate design data from CAD data (DXF or IGES file) or text data. Furthermore, since you can also convert measurement data into design data, you can save parts data prior to use (testing) as design data and effectively utilize it for checking the wear following use (testing).

Data combination function

You can combine partial data collected separately from a work-piece (made necessary due to shape characteristics) into a single graphic for convenient analysis.

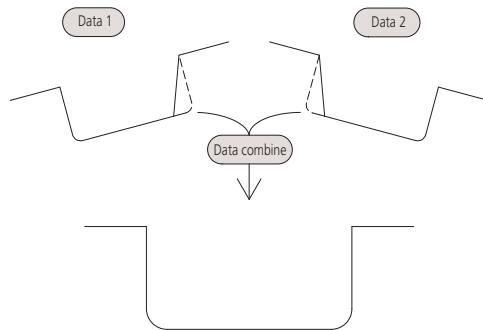

Calculation command repetition setting

When identical shapes have the same pitch, you can analyze all of the shapes in a batch by specifying a single analysis location and the pitch.

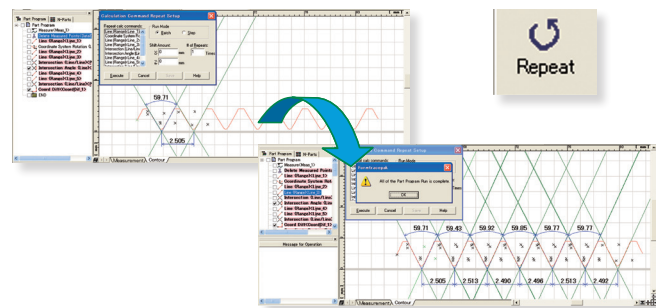

Best-fit processing function for measurement point strings

This function tries to fit the measurement points to the stored reference data on the same coordinate system. It can eliminate the effects of a shift that may occur when setting the workpiece during automatic analysis.

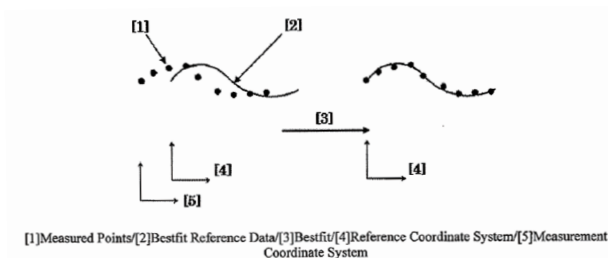

Data superimposition command

You can superimpose two sets of data by detecting their characteristic points. Use the mouse to drag and move the measurement point strings to the desired positions to be superimposed.

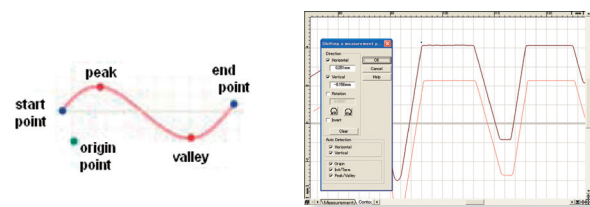

Integrated layout

You can use simple operations to lay out graphics obtained from measurements as well as measurement results for surface roughness, contour, and roundness on a single page. Furthermore, since the program now allows you to specify a saved file and paste it, you can easily paste results from multiple files.

Note: the optional ROUNDPAK roundness/cylindricity analysis program is required.
(Ver. 7 or higher)

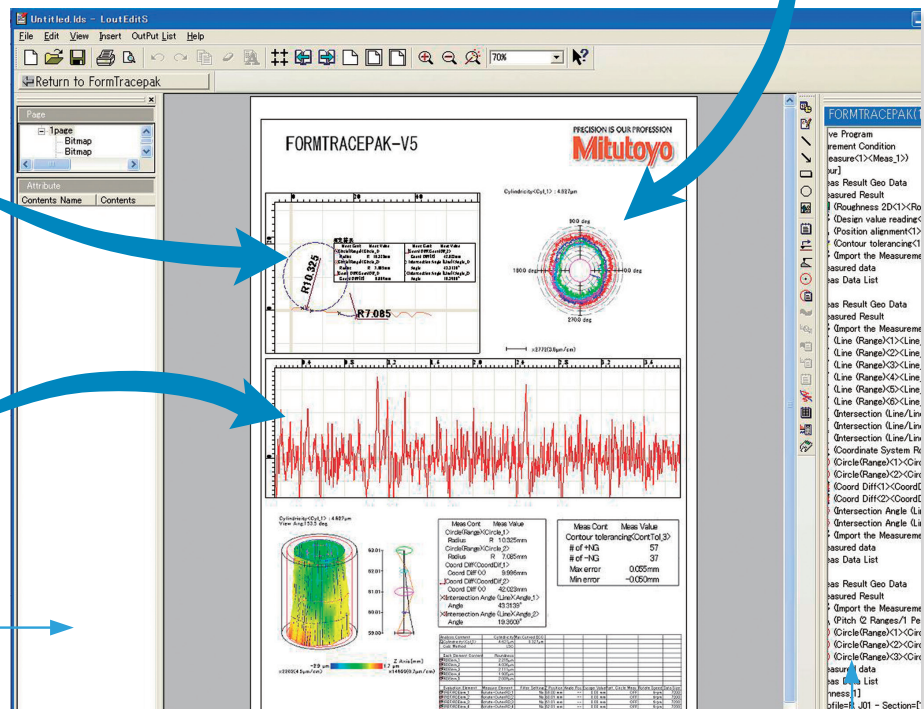
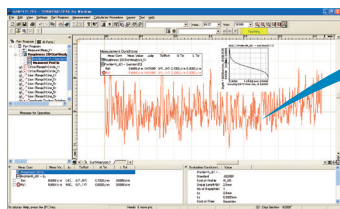
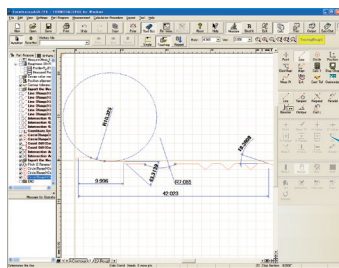
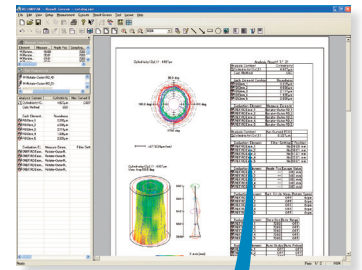

Element information bar

This bar displays the attribute values of the pasted items, allowing you to easily check the contents of the pasted measurement data files.

System layout printing

By simply selecting the items to be output, you can automatically lay out the page to be printed. Use this feature when you wish to simplify the printing task.

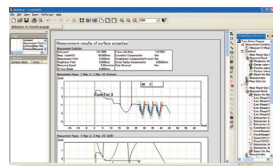
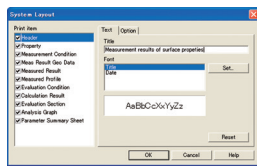

Report creation function

You can freely assemble measurement results/conditions/graphics as well as comments/circles/lines/arrows, and print them out in a measurement result report. Furthermore, since you can paste bitmap files, you can also add a workpiece image or company logo to the layout. You can also save the created layout and use it again later for similar measurements.

Element insertion bar

Using the mouse to drag and drop the analysis content displayed in the element insertion bar, you can paste it into the layout. From the contour analysis result, you can also select the analysis result for a circle or line alone and paste it in position.

Saving the result as a web page

Since you can save the result in html or mhtml format, which can be displayed using Internet Explorer or Microsoft Word, you can check the result even on a PC on which no layout-editing program is installed.

Optional Accessories for Automatic Measurement

Y-axis table: 178-097*

Enables efficient, automatic measurement of multiple aligned workpieces and multiple points on a single measurement surface.

* Y-axis table is only for positioning, not supported Y-direction measurement.

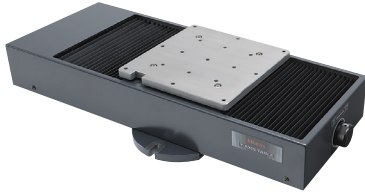

Travel range	200mm
Resolution	0.05μm
Positioning accuracy	±3μm
Drive speed	Max 80mm/s
Maximum load	50kg
Mass	28kg

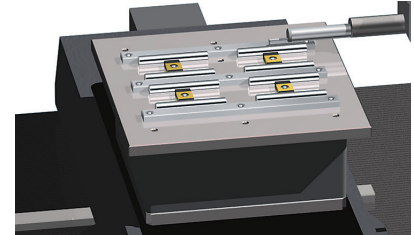

Rotary Table θ1-axis table: 12AAD975*

For efficient measurement in the axial/transverse directions. When measuring a cylindrical workpiece, automatic alignment can be performed in combination with the Y-axis table.

* θ1-axis mounting plate (12AAE630) is required when directly installing on the base of the CV-3200/4500 series.

θ1-axis rotary table is only for positioning and does not support rotational measurement.

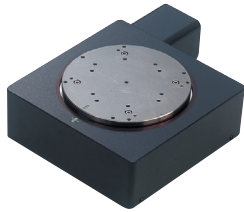

Displacement	360°
Resolution	0.004°
Maximum load	12kg
Rotational speed	Max 10°/s
Mass	7kg

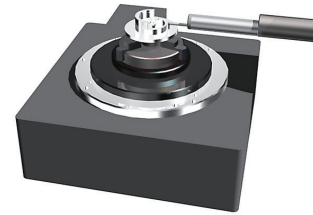

Rotary Table θ2-axis unit: 178-078*

You can measure multiple points on a cylindrical workpiece and automate front/rear-side measurement.

* θ2-axis mounting plate (12AAE718) is required when directly installing on the base of the CV-3200/4500 series.

θ2-axis rotary table is only for positioning and does not support rotational measurement.

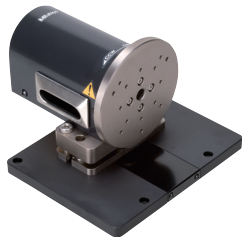

Displacement	360°
Resolution	0.0072°
Maximum load (loading moment)	4kg (343 N·cm or less)
Rotational speed	Max 18°/s
Mass	5kg

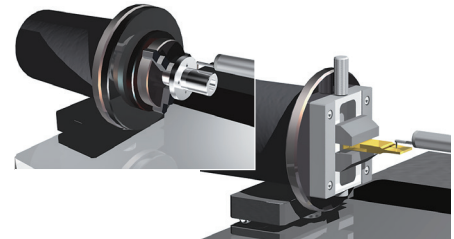

Centering chuck (ring operated): 211-032

This chuck is useful when measuring small workpieces. You can easily clamp them with its knurled ring.

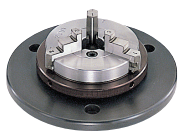

Retention range	Inner latch	OD: ø1 - ø36mm
	Inner latch	ID: ø16 - ø69mm
	Outer latch	OD: ø25 - ø79mm
Dimensions	ø118x41mm	
Mass	1.2kg	

Micro-chuck: 211-031

This chuck is suitable for clamping extra-small diameter workpieces (ø1 mm or less), which cannot be retained with the centering chuck.



Retention range	OD: ø0.1 - ø1.5mm
Dimensions	ø118 x48.5mm
Mass	0.6kg

Optional Accessories

3-axis Adjustment Table: 178-047

This table helps make the adjustments required when measuring cylindrical surfaces. The corrections for the pitch angle and the swivel angle are determined from a preliminary measurement and the Digimatic micrometers are adjusted accordingly. A flat-surfaced workpiece can also be leveled with this table. By using Mitutoyo's 3-axis adjustment table, the workpiece can be aligned and leveled easily, simply by following the FORMTRACEPAK guidance. No experience or special expertise is required.



(V-block not included)

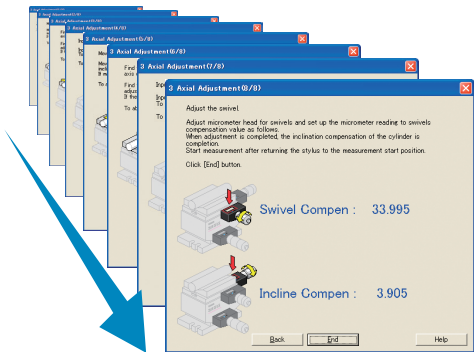

Guidance display when using 3-axis adjustment table

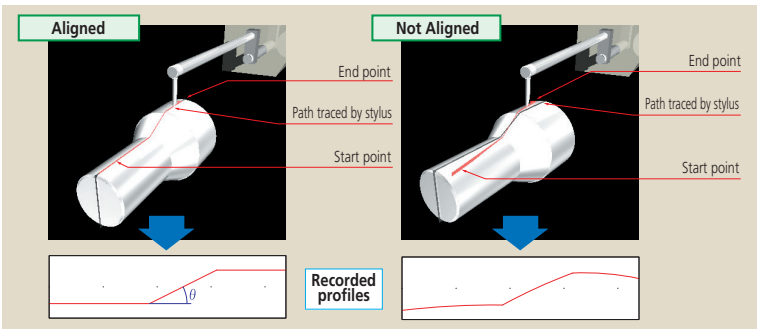
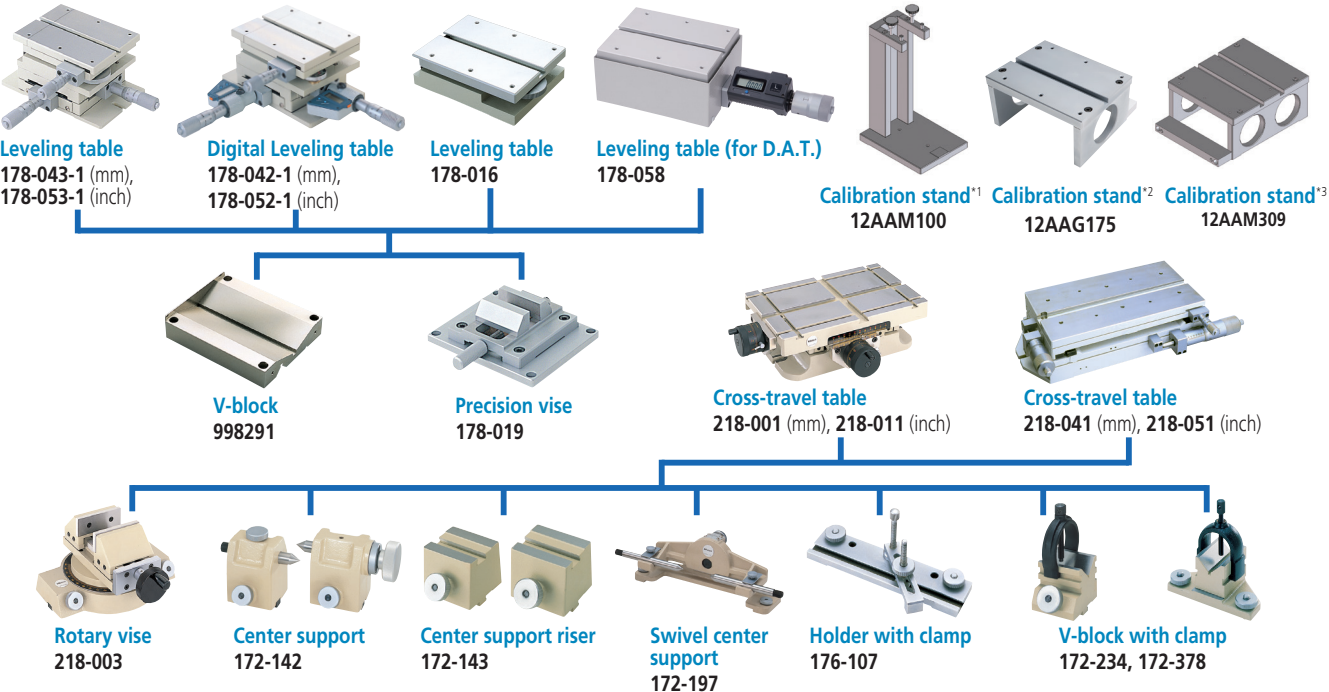

Table and fixture systems



*1 Required for calibrating upward measurement of CV-3200 series.
 *2 Required for batch calibration when using straight arm/small-hole stylus arm without using cross-travel table and Y-axis table.
 *3 Required for batch calibration when using straight arm/eccentric am/small-hole stylus arm without using cross-travel table and Y-axis table.

Optional Accessories

Vibration isolators

Desk types

Desk type*1
No.12AAK110

Monitor arm*2
No.12AAK120

Side table*3
No.12AAL019



Example combination: with side table but no monitor arm (tester and PC not included)

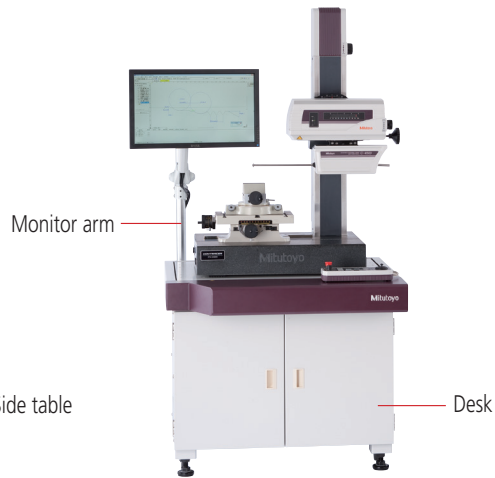

Example combination: with monitor arm but no side table*3 (tester and PC not included)

*1 For models with a product code that ends in **S4**, **S8**, **H4**, or **H8**. Please contact us directly if you require units for models with a product code that ends in **W4** or **W8** (large base models).

*2 Used together with vibration isolator (No.12AAK110).

*3 User to provide a printer rack.

Desktop types

Manually charged pneumatic type*4
No.178-023

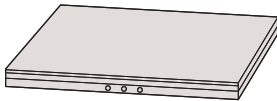

Automatically charged pneumatic type*4
No.178-025

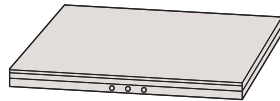

Stand for Desktop type
External size (WxDxH):
640x470x660mm
Mass: 25kg
No.178-024

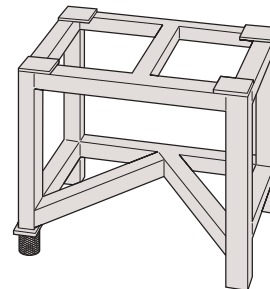

*4 For models with a product code that ends in **S4**, **S8**, **H4**, or **H8**. Please contact us directly if you require units for models with a product code that ends in **W4** or **W8** (large base models).

Arms

Description	Arm No.	Parts No.	Applicable stylus No.
Straight arm	AB-31*5	12AAM101	SPH-5*, 6*, 7*, 8*, 9*, SPHW*6-56,66,76
Eccentric arm	AB-37	12AAQ762	SPH-5*, 6*, 7*, 8*, 9*, SPHW*6-56,66,76
Small-hole arm	AB-33	12AAM103	SPH-41, 42, 43

*5 Standard accessory

*6 Stylus for CV-4500 series

*7 One-sided cut stylus SPH-71 (standard accessory) mounting

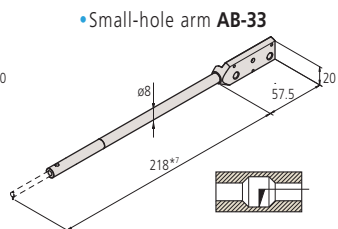
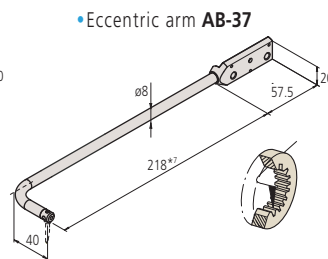
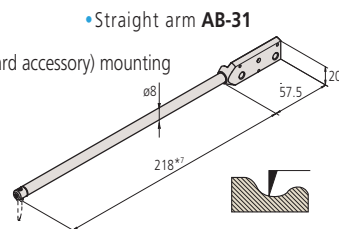

Styli

Stylus name	Stylus No.	Parts No.	Application arm No.	H (mm)
Double-sided conical stylus*1	SPHW-56	12AAM095*2	AB-31, AB-37	20
	SPHW-66	12AAM096	AB-31, AB-37	32
	SPHW-76	12AAM097	AB-31, AB-37	48
One-sided cut stylus	SPH-51	354882	AB-31, AB-37	6
	SPH-61	354883	AB-31, AB-37	12
	SPH-71	354884*2*3	AB-31, AB-37	20
	SPH-81	354885	AB-31, AB-37	30
	SPH-91	354886	AB-31, AB-37	42
Intersecting cut stylus	SPH-52	354887	AB-31, AB-37	6
	SPH-62	354888	AB-31, AB-37	12
	SPH-72	354889	AB-31, AB-37	20
	SPH-82	354890	AB-31, AB-37	30
	SPH-92	354891	AB-31, AB-37	42
Cone stylus Tip angle 30° Sapphire tipped	SPH-53	354892	AB-31, AB-37	6
	SPH-63	354893	AB-31, AB-37	12
	SPH-73	354894	AB-31, AB-37	20
	SPH-83	354895	AB-31, AB-37	30
	SPH-93	354896	AB-31, AB-37	42
Cone stylus Tip angle 30° Carbide-tipped	SPH-56	12AAA566	AB-31, AB-37	6
	SPH-66	12AAA567	AB-31, AB-37	12
	SPH-76	12AAA568	AB-31, AB-37	20
	SPH-86	12AAA569	AB-31, AB-37	30
	SPH-96	12AAA570	AB-31, AB-37	42
Cone stylus Tip angle 20° Carbide-tipped	SPH-57	12AAE865	AB-31, AB-37	6
	SPH-67	12AAE866	AB-31, AB-37	12
	SPH-77	12AAE867	AB-31, AB-37	20
Cone stylus Tip angle 20° Carbide-tipped	SPH-87	12AAE868	AB-31, AB-37	30
	SPH-97	12AAE869	AB-31, AB-37	42
Cone stylus Tip angle 50° Diamond tipped	SPH-79	355129	AB-31, AB-37	20
Knife edge stylus	SPH-54	354897	AB-31, AB-37	6
	SPH-64	354898	AB-31, AB-37	12
	SPH-74	354899	AB-31, AB-37	20
	SPH-84	354900	AB-31, AB-37	30
	SPH-94	354901	AB-31, AB-37	42
Ball stylus	SPH-55	354902	AB-31, AB-37	6
	SPH-65	354903	AB-31, AB-37	12
	SPH-75	354904	AB-31, AB-37	20
	SPH-85	354905	AB-31, AB-37	30
	SPH-95	354906	AB-31, AB-37	42
Small hole stylus*4	SPH-41	12AAM104	AB-33	2
	SPH-42	12AAM105	AB-33	4
	SPH-43	12AAM106	AB-33	6.5

*1 Stylus for CV-4500 series

*2 Standard accessory of CV-4500 series

*3 Standard accessory of CV-3200 series

*4 Styli SPH-21, 22, and 23 for CV-3100/4100 series are not available.

Arm stylus (comprising an arm and stylus)

Arm stylus name	Stylus No.	Parts No.	H (mm)
Double-sided small hole arm stylus	SPHW-31	12AAM108	2.4
	SPHW-32	12AAM109	5
	SPHW-33	12AAM110	9

*5 Arm Stylus for CV-4500 series

Double-sided small hole arm stylus SPHW-31

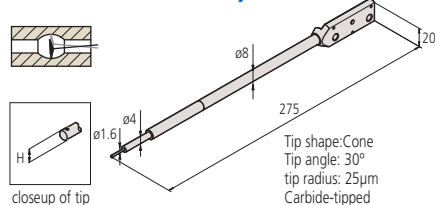

Double-sided small hole arm stylus SPHW-32

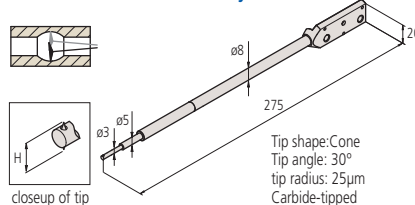

Double-sided small hole arm stylus SPHW-33

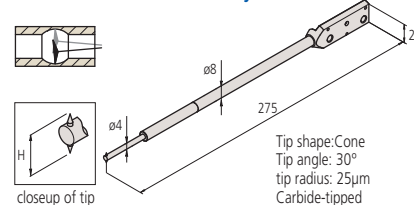

Double-sided conical stylus

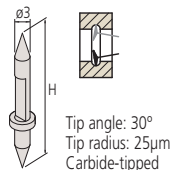

Cone stylus

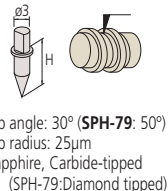

Small hole stylus SPH-41

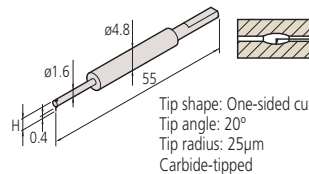

One-sided cut stylus

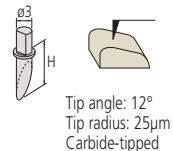

Cone stylus

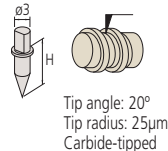

Small hole stylus SPH-42

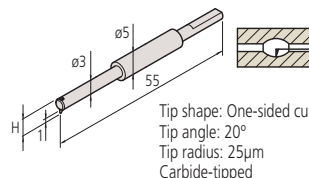

Intersecting cut stylus

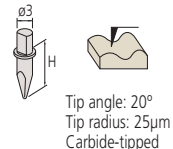

Knife edge stylus

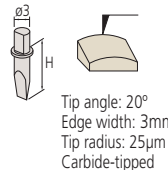

Small hole stylus SPH-43

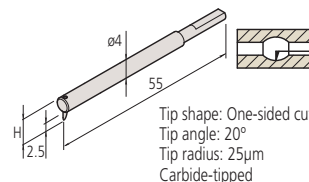

Ball stylus

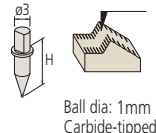

Specifications

Model Order No.		CV-3200S4	CV-3200H4	CV-3200W4	CV-3200L4	CV-3200S8	CV-3200H8	CV-3200W8	CV-3200L8	
		218-491-10A	218-492-10A	218-493-10A	218-494-10A	218-494-10A	218-497-10A	218-498-10A	218-499-10A	
		CV-4500S4	CV-4500H4	CV-4500W4	CV-4500L4	CV-4500S8	CV-4500H8	CV-4500W8	CV-4500L8	
		218-451-10A	218-452-10A	218-453-10A	218-454-10A	218-456-10A	218-457-10A	218-458-10A	218-459-10A	
Measuring range	X axis	100mm				200mm				
	Z1 axis (detector unit)	60mm (±30mm in horizontal situation)								
Z2 axis (column) travel range		300mm	500mm	700mm	300mm	500mm	700mm			
Detector (Z1 axis (detector unit))	Scale unit	Arc scale								
	Resolution	CV-3200 series: 0.04µm, CV-4500 series: 0.02µm								
	Stylus up/down motion	Arc movement								
	Measuring direction	Both pulling and pushing directions								
	Measuring face direction	CV-3200 series: Downward or upward CV-4500 series: Both upward and downward (direction switch from FORMTRACEPAK)								
	Measuring force	CV-3200 series: 30mN (by adjusting weight) CV-4500 series: 10, 20, 30, 40, 50mN (Setting measuring force FORMTRACEPAK)								
	Stylus traceable range	Ascent 77°, Descent 83° (with one-sided cut stylus: standard accessory)								
Drive unit	Scale unit	X axis	Separate type linear encoder							
		Z2 axis (column)	ABS encoder							
	Resolution	X axis	0.05µm							
		Z2 axis (column)	1µm							
	Drive speed	X axis	0 - 80mm/s and manual operation							
		Z2 axis (column)	0 - 30mm/s and manual operation							
	Measuring speed	X axis	0.02 - 20mm/s							
	Straightness (when the X axis is horizontal)	X axis	0.8µm/100mm				2µm/200mm			
X axis inclination angle	X axis	±45°								
Accuracy (20°C)	CV-3200 Series	X axis	±(0.8 + 0.01L) µm L = Drive length (mm) Wide range: 1.8µm/100mm Narrow range: 1.05µm/25mm				±(0.8 + 0.02L) µm L = Drive length (mm) Wide range: 4.8µm/200mm Narrow range: 1.3µm/25mm			
		Z1 axis (column)	±(1.4 + 2H /100) µm H = Measurement height from the horizontal position							
	CV-4500 Series	X axis	±(0.8 + 0.01L) µm L = Drive length (mm) Wide range: 1.8µm/100mm Narrow range: 1.05µm/25mm				±(0.8 + 0.02L) µm L = Drive length (mm) Wide range: 4.8µm/200mm Narrow range: 1.3µm/25mm			
		Z1 axis (column)	±(0.8 + 2H /100) µm H = Measurement height from the horizontal position							
External dimensions (WxDxH)	Main unit	756x482x966mm	756x482x1166mm	1156x482x1176mm	1156x482x1436mm	766x482x966mm	766x482x1166mm	1166x482x1176mm	1156x482x1436mm	
	Controller	221x344x490mm								
	Remote box	248x102x62.2mm								
Mass	Main unit	140kg	150kg	220kg	270kg	140kg	150kg	220kg	270kg	
	Controller	14kg								
	Remote box	0.9kg								
Operating temperature range		15 - 25°C (within ±1K temperature fluctuation on calibration and measurement)								
Operating humidity range		20 - 80%RH (with no condensation)								
Storage temperature range		-10 to 50°C								
Storage humidity range		5 - 90%RH (with no condensation)								

Dimensions

CV-3200S4/H4/W4/L4, CV-4500S4/H4/W4/L4

Unit: mm

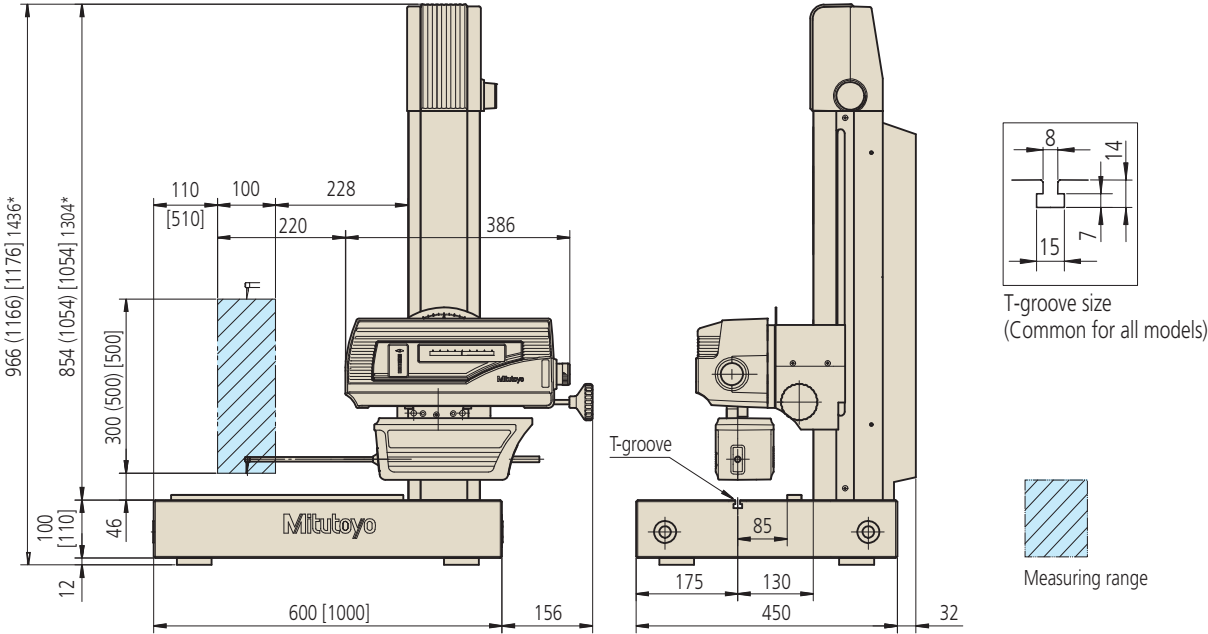

- () : CV-3200H4, CV-4500H4
- [] : CV-3200W4, CV-4500W4
- * : CV-3200L4, CV-4500L4

The CV-3200 series detector comes with weights for adjusting the measuring force.

CV-3200S8/H8/W8/L8, CV-4500S8/H8/W8/L8

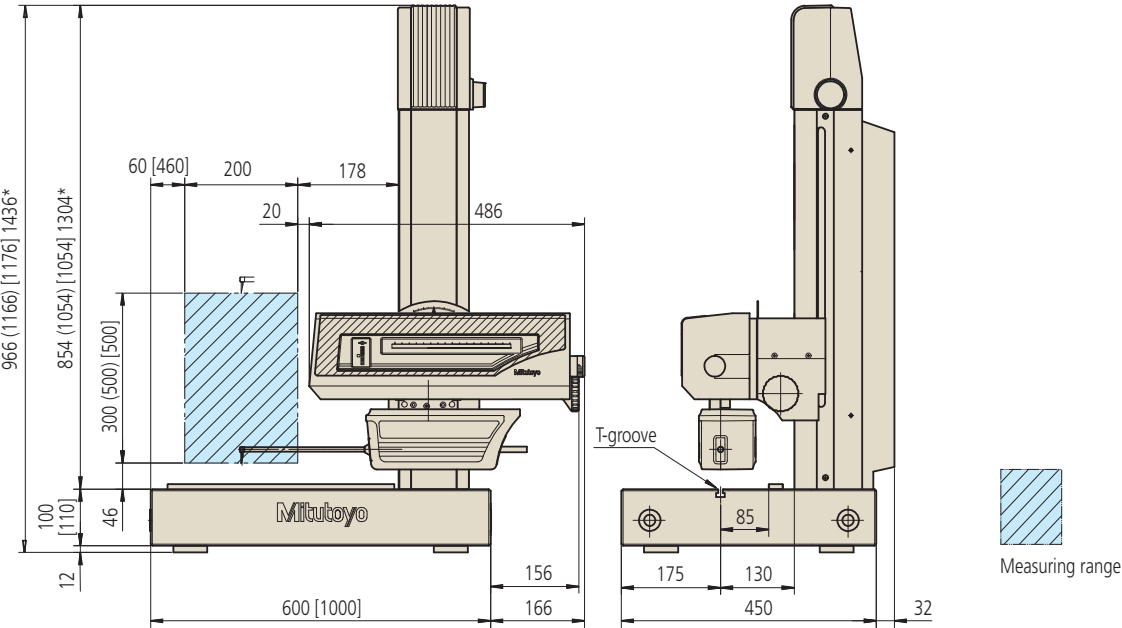

- () : CV-3200H8, CV-4500H8
- [] : CV-3200W8, CV-4500W8
- * : CV-3200L8, CV-4500L8

The CV-3200 series detector comes with weights for adjusting the measuring force.

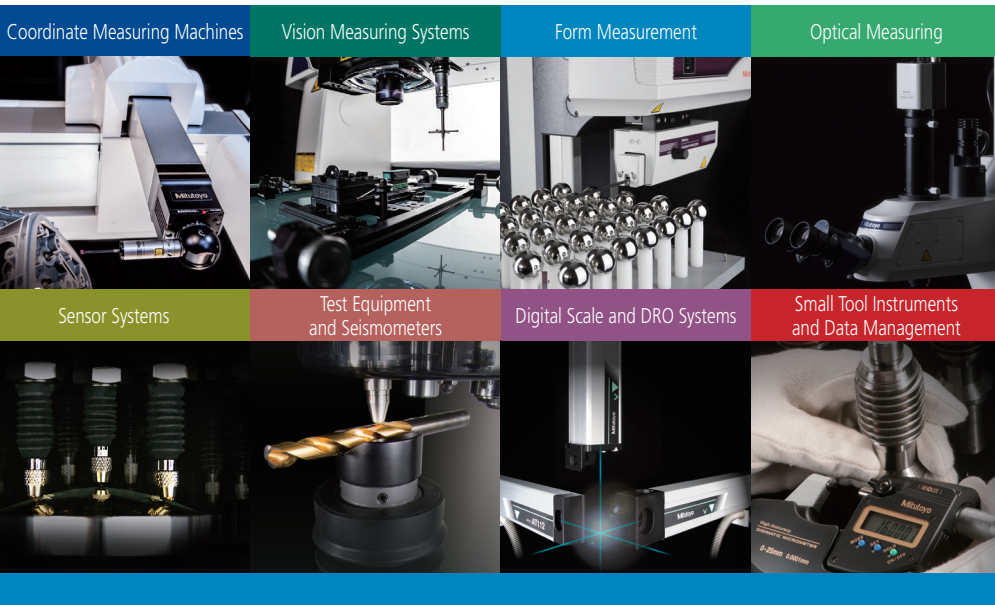

**Whatever your challenges are,
Mitutoyo supports you from start to finish.**

Mitutoyo is not only a manufacturer of top-quality measuring products but one that also offers qualified support for the lifetime of the equipment, backed by comprehensive services that ensure your staff can make the very best use of the investment.

Apart from the basics of calibration and repair, Mitutoyo offers product and metrology training, as well as IT support for the sophisticated software used in modern measuring technology. We can also design, build, test and deliver measuring solutions and even, if deemed cost-effective, take your critical measurement challenges in-house on a sub-contract basis.



**Find additional product literature
and our product catalog**

www.mitutoyo.com

Note: All information regarding our products, and in particular the illustrations, drawings, dimensional and performance data contained in this printed matter as well as other technical data are to be regarded as approximate average values. We therefore reserve the right to make changes to the corresponding designs. The stated standards, similar technical regulations, descriptions and illustrations of the products were valid at the time of printing. In addition, the latest applicable version of our General Trading Conditions will apply. Only quotations submitted by ourselves may be regarded as definitive. Specifications are subject to change without notice.

Mitutoyo products are subject to US Export Administration Regulations (EAR). Re-export or relocation of our products may require prior approval by an appropriate governing authority.

Trademarks and Registrations

Designations used by companies to distinguish their products are often claimed as trademarks. In all instances where Mitutoyo America Corporation is aware of a claim, the product names appear in initial capital or all capital letters. The appropriate companies should be contacted for more complete trademark and registration information.



Mitutoyo America Corporation

www.mitutoyo.com
One Number to Serve You Better
1-888-MITUTOYO (1-888-648-8869)

M³ Solution Centers:

- Aurora, Illinois (Headquarters)
- Boston, Massachusetts
- Charlotte, North Carolina
- Cincinnati, Ohio
- Detroit, Michigan
- Los Angeles, California
- Birmingham, Alabama
- Seattle, Washington
- Houston, Texas