

## SURFTEST SJ-500/SV-2100 SURFACE ROUGHNESS MEASURING SYSTEM

Surface roughness testers offer benchtop or portable operation and the choice of data analysis by PC or an easy-to-use dedicated processor



# Dedicated data processor type

## Surftest SJ-500/SV-2100

### Improved operability

#### 7.5 Color TFT LCD

The dedicated data processor has a high-visibility 7.5" color TFT LCD. Icon display and touch panel operation provide user-friendly display and easy operation.

#### Positioning by joystick and manual control knobs on the processor

Easy-to-operate joystick. Fine positioning of stylus required for small-hole measurements can be easily performed using the manual fine-adjustment knobs.

#### Multiple trace function

A machine can be programmed to take up to three traces, one after the other.

### Various types of analysis

#### Capable of fine-contour analysis

Supports 43 types of analysis parameters, complying with surface roughness standards such as ISO 1997 and JIS 2001. Also capable of various fine-contour analysis.

\* Contour analyses: Area, circle, angle, coordinate difference, step, inclination

### High-durability

#### Ceramic guideway

A ceramic guideway, inherently free from wear and deterioration with age, is employed to maintain the traversing straightness of the drive unit (X-axis) indefinitely. Maintenance-free design, since anti-corrosion treatment is not required for ceramic.

#### SJ-500

Traverse: 1.97" (50mm)  
Compact, high-performance type

#### SV-2100M4

Traverse: 3.94" (100mm)  
Manual column type

#### SV-2100S4/H4/W4

Traverse: 3.94" (100mm)  
Power column type

#### Dedicated data processor

Advanced processing and easy operation



# Easy operation, high-accuracy analysis of surface roughness and fine contours!

## High-visibility color display panel

A high-visibility 7.5" color TFT LCD, color icon display and touch-operated panel provide user-friendly, easy operation. Built-in thermal printer. Fine contour analysis provided as standard.



### Supports 16 languages

Japanese, English, German, French, Italian, Spanish, Portuguese, Korean, Simplified Chinese, Traditional Chinese, Czech, Polish, Hungarian, Turkish, Swedish, Dutch

## Multiple trace programming function

A machine can be programmed to take up to three consecutive traces by one-key operation, as shown in the figure below.

•**SJ-500/SV-2100M4**  
Consecutive tracing in X-axis direction only

•**SV-2100S4/H4/W4**  
X-axis tracing with programmed Z-axis shifts possible

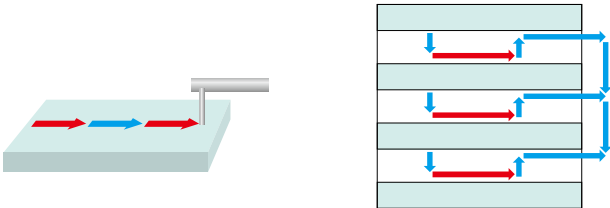

**→ Measurement**  
**→ Traverse**

Example: SV-2100S4 input screen



## Efficient positioning by joystick and adjustment knobs

Both a fast-traverse joystick (X-axis: .78"/s (20mm/s) for **SJ-500**, 1.98"/s (40mm/s) for **SV-2100**, Z2-axis: .78"/s (20mm/s) for **SV-2100S4/H4/W4**) and manual fine-adjustment knobs, essential for positioning in small hole measurement, are standard features.

### Positioning in small hole measurement

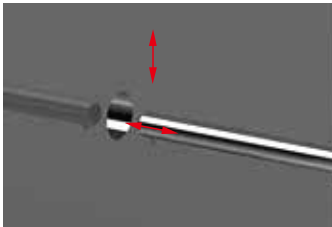

Positioning in YZ-directions with column fine-adjustment knob (or detector elevation knob) and optional cross-travel table.



Positioning at the trace start point with X-axis fine-adjustment knob.

## Navigation function aids leveling

### Powerful support for leveling adjustments

When using an optional 3-axis adjustment table or leveling table, a navigation screen is available to help the operator level the surface to be tested.

### Example of 3-axis adjustable table



The user is guided through the leveling procedure to determine the amount of adjustment needed.

# A portable tester also boasting high performance in desktop applications

## Surftest SJ-500

High accuracy, high performance, user-friendly display and easy operation

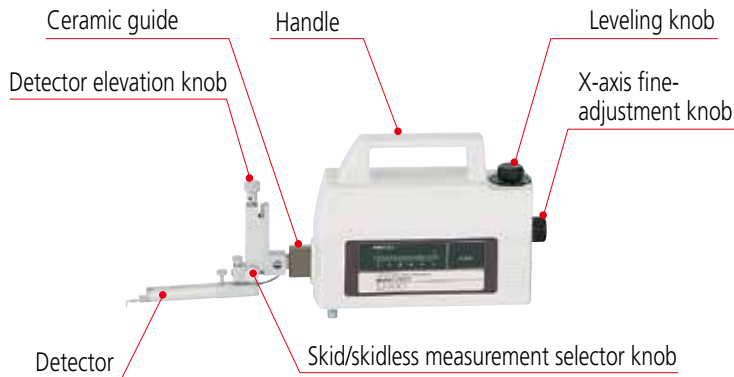

*Class-leading traverse straightness:  
8µin/2" (0.2µm/50mm)*  
*High-speed traverse at up to 0.78"/s (20mm/s)  
under joystick control*  
*Smooth positioning using the vertical  
adjustment knob*

### Vertical adjustment knob

Essential for positioning the stylus close to the workpiece!



### Support for testing problematic features

Supports measurement in the axial direction for shrouded features, such as found on crankshafts, by simply swiveling the detector through 90 degrees.

Normal tracing



Tracing a shrouded feature

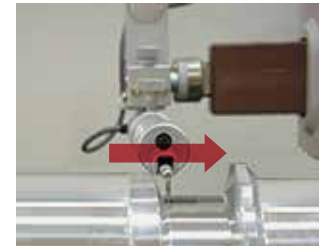

### Drive unit inclination adjustment mechanism

Digital Adjustment Tilting (DAT) function is supplied as standard for efficient leveling of workpieces: ±1.5°  
DAT function: Patent pending (Japan, U.S., Germany)

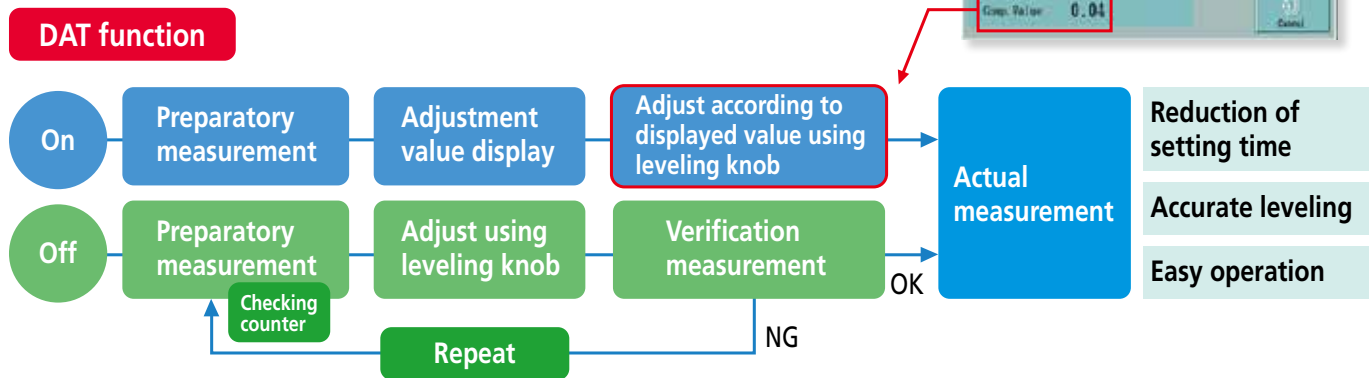

# A desktop tester that's easy to use for portable applications

## Surftest SV-2100

By setting the origin point at start-up, the Absolute scale system allows accurate positioning for repeated or multiple measurements.

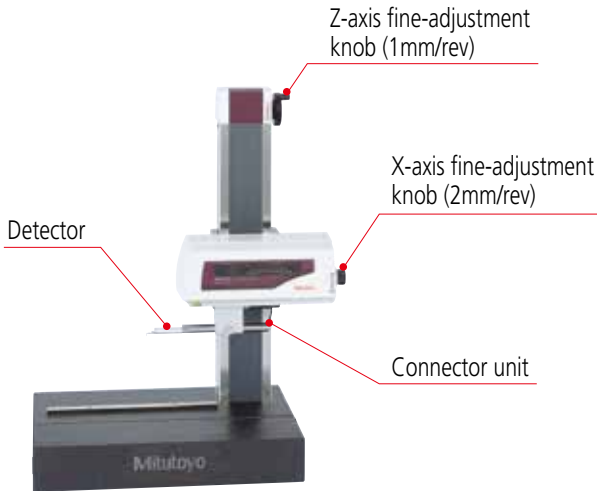

SV-2100M4

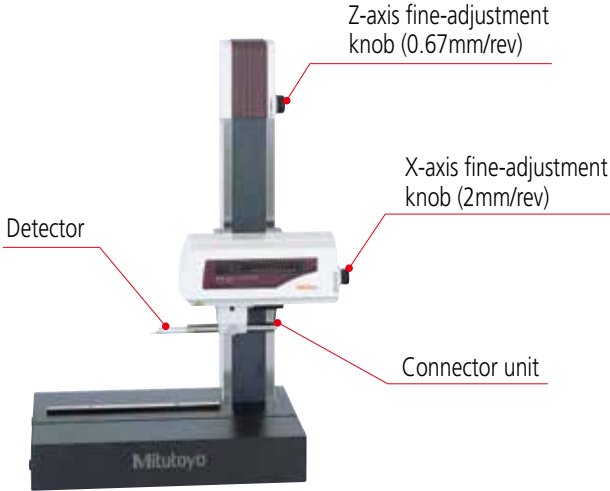

SV-2100S4

*High-speed traverse at up to 1.98"/s (40mm/s) (X-axis) under joystick control*  
*Smooth positioning, using the Z-axis fine-adjustment knobs*  
*Stable, high-accuracy measurement with a traverse straightness of 6µin/4" (0.15µm/100mm)*

1. Capable of a series of automatic measurements, plus auto leveling (optional) and stylus retraction. Accurate positioning for repeated or multiple measurements possible.



Measurement setup screen

2. **SV-2100S4/H4/W4** models are equipped with an emergency stop button.



3. Base sizes and vertical travel range on column

Model No.	Vertical travel range	Vertical traverse method	Base size
<b>SV-2100S4</b>	13.8" (350mm)	Power and manual	23.6" x 17.72" (600x450mm)
<b>SV-2100H4</b>	21.6" (550mm)		39.4" x 17.72" (1000x450mm)
<b>SV-2100W4</b>		Manual only	23.6" x 17.72" (600x450mm)

# Dedicated data processor

## Data processing unit

- Data saving (internal memory)
- High-speed printing
- Expansion slot for external memory (CF card)
- Display supports 16 languages
- Key panel



- High-visibility 7.5" color LCD
- Touch panel with color icon display
- Joystick

## Customizable menu screen

The menu customization function allows display of frequently used menu icons

One-touch display of various screens



Home screen



Evaluation setup screen



Measurement setup screen



Calibration screen



Contour analysis screen

## Statistical processing

Statistical data processing possible (up to 300 data samples)  
 Statistical processing items: MAX, MIN, average, standard deviation, histogram, probability of acceptance.

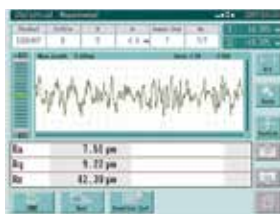

Statistical data input



Statistical results

## Saving and recalling measurement setups

Up to 10 measurement setups can be saved to and recalled from internal memory.

One-touch recall of stored setups

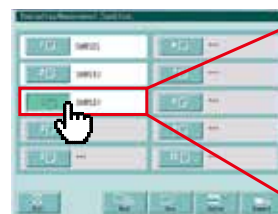

Click the desired measurement setup file

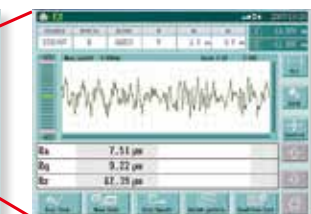

Measurement screen opens

### Analysis to international standards

Evaluates surface roughness using up to 43 parameters complying with international standards such as ISO 1997 and JIS 2001. Bearing Area Curve (BAC), Amplitude Distribution Curve (ADC), and power spectrum (wavelength display) are readily available in graph form.

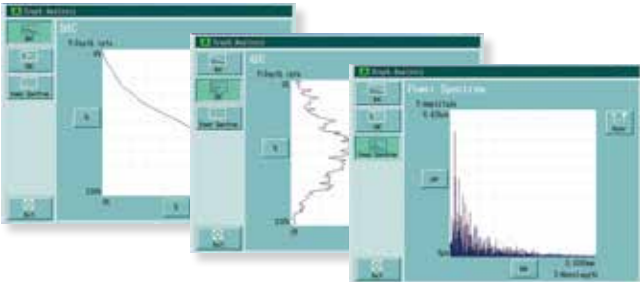

### A large variety of optional accessories

Options supporting measurement including an auto leveling table, a 3-axis adjustment table, and a leveling table. Furthermore, these can be easily operated via a navigation function. (Supported accessories differ depending on the model.)



### Easy, icon-based input of setup conditions

\* Patent pending

Setups are aided by icons representing ISO/JIS roughness standard parameters with appropriate values selected from recommended lists.

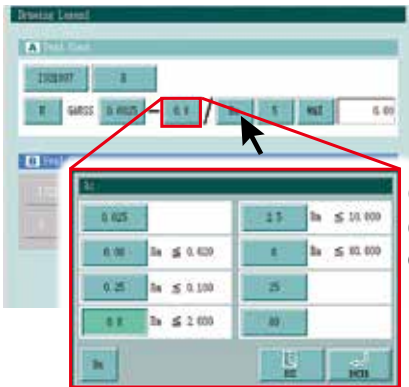
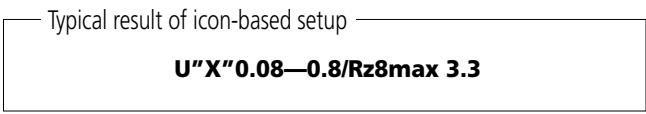
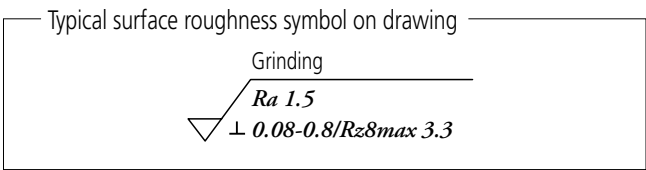

Clicking a parameter icon displays the recommended cut-off value, etc.

### Fine-contour analysis

Various contour analyses (area, circle, angle, coordinate difference, step, inclination) are supplied as standard.



Select desired analysis icon and then specify the range.

### Built-in thermal printer

Measurement data is printed by the high-definition, high-speed thermal printer. In addition to calculation results and evaluation results, BAC, ADC and other curves can also be printed.



### Simplified communication program for SURFTEST SJ-500/SV-2100

The SurfTest **SJ-500/SV-2100** Series has a USB interface, enabling data to be transferred to a spreadsheet or other software. We also provide a program that lets you create inspection record tables using a Microsoft Excel\* macro.

This program can be downloaded free of charge from the Mitutoyo website.  
<https://www.mitutoyo.co.jp>

- OS: Windows XP-SP3  
 Windows Vista  
 Windows 7  
 Windows 8  
 Windows 10
- Spreadsheet software: Microsoft Excel 2000  
 Microsoft Excel 2002  
 Microsoft Excel 2003  
 Microsoft Excel 2007  
 Microsoft Excel 2010  
 Microsoft Excel 2013  
 Microsoft Excel 2016

\* Windows OS and Microsoft Excel are products of Microsoft Corporation.  
**The optional USB cable is also required.**  
 USB cable for **SJ-500/SV-2100** Series **12AAH490**

# PC data processing type Surftest SJ-500P

A superior data processing tester with PC data analysis for higher efficiency.

\* If a power column type with PC data-processing is desired, consider the SV-3100 series



SJ-500P

## FORMTRACEPAK: Best-seller for surface roughness analysis

A best-seller dedicated software especially for surface roughness measurement and analysis capable of free print format settings for original inspection certificates.

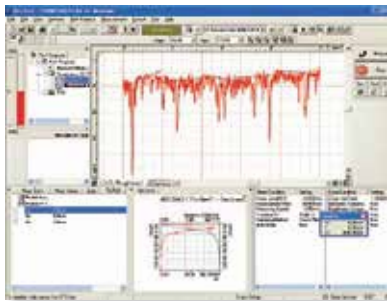

Measurement and results display screen



Setup definition screen

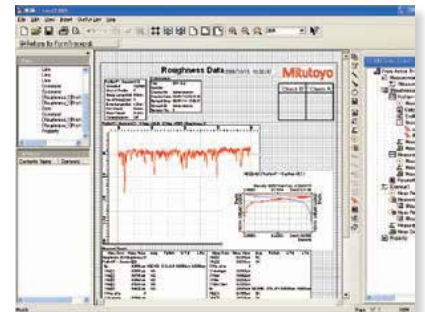

Printing screen



# Specifications

## Specifications

Type of data processing	Dedicated data processor					PC system	
Model No.	SJ-500	SV-2100M4	SV-2100S4	SV-2100H4	SV-2100W4	SJ-500P	
Order No.*	with 0.75 mN detector	178-533-01A	178-637-01A	178-681-01A	178-683-01A	178-685-01A	178-531-01A
	with 4 mN detector	178-533-02A	—	—	—	—	—
Travel range (operation)	X axis	2" (50mm) (power drive/manual)	3.94" (100mm) (power drive / manual)			2" (50mm) (power drive / manual)	
	Z2 axis (column)	—	350mm (manual)	13.8" (350mm) (power drive / manual)		—	
Measuring range	X axis	2" (50mm)	3.94" (100mm)			2" (50mm)	
	Z1 axis (detector unit)	3200µin / 3200µin / 320µin (800µm / 80µm / 8µm)					
Resolution	X axis	1.97µin (0.05µm)					
	Z1 axis (detector unit)	0.4µin / 32000µin range, 0.04µin / 3200µin range, 0.004µin / 320µin range (0.01µm / 800µm range, 0.001µm / 80µm range, 0.0001µm / 8µm range)					
Power drive speed	X axis	0 - 0.78"/s 0 - 20mm/s (via joystick)	0 - 1.98"/s (0 - 40mm/s) (via joystick)			0 - 20mm/s (via PC)	
	Z2 axis (column)	—	0 - 0.78"/s (0 - 20mm/s) (via joystick)		—		
Measuring speed	0.00078" - 0.2"/s (0.02 - 5mm/s)						
X-axis straightness	8 µin / 2" (0.2µm / 50mm)		6 µin / 4" (0.15µm / 100mm)			8 µin / 2" (0.2µm / 50mm)	
Stylus up/down operation	Arc movement						
Point of stylus	Downward						
Detector	Measuring force	0.75 mN or 4 mN					
	Stylus tip	0.75mN detector: 60°, R2 µm or 4mN detector: 90°, R5µm					
Applicable standards	JIS'82 / JIS'94 / JIS'01 / ISO'97 / ANSI / VDA						
Assessed profiles	Dedicated data processor type: P (primary profile), R (roughness profile), WC, envelope residual profile, roughness motif, waviness motif PC system type: P (primary profile), R (roughness profile), WC, WCA, WE, WEA, DIN4776 profile, E (envelope residual profile), roughness motif, waviness motif						
Evaluation parameters	Dedicated data processor type: Ra, Rc, Ry, Rz, Rq, Rt, Rmax, Rp, Rv, R3z, Sm, S, Pc, mr (c), δc, mr, tp, Htp, Lo, lr, Ppi, HSC, Δa, Δq, Ku, Sk, Rpk, Rvk, Rk, Mr1, Mr2, A1, A2, Vo, λa, λq, R, AR, Rx, W, AW, Wx, Wte, (43 parameters), Customization PC system type: Pa, Pq, Psk, Pku, Pp, Pv, Pz, Pt, Pc, PSm, PΔq, Pmr (c), Pmr, Pδc, Ra, Rq, Rsk, Rku, Rp, Rv, Rz, Rt, Rc, RSm, RΔq, Rmr (c), Rmr, Rδc, Wa, Wq, Wsk, Wku, Wp, Wv, Wz, Wt, Wc, WSm, WΔq, Wmr (c), Wmr, Wδc, Rk, Rpk, Rvk, Mr1, Mr2, A1, A2, Rx, AR, R, Wx, AW, W, Wte, Ry, RyDIN, RzDIN, R3y, R3z, S, HSC, Lo, lr, Δa, λa, λq, Vo, Htp, NR, NCRX, CPM, SR, SAR, NW, SW, SAW						
Analysis graphs	Dedicated data processor type: ADC, BAC, power spectrum graph PC system type: ADC, BAC Graph, power spectrum graph, auto-correlation graph, Walsh power spectrum graph, Walsh auto-correlation graph, slope distribution graph, local peak distribution graph, parameter distribution graph						
Curved surface compensation	Dedicated data processor type: Parabolic compensation, Hyperbolic compensation, Elliptical compensation, Circular compensation Conic compensation, Inclination (Entire, Arbitrary) PC system type: Parabolic compensation, Hyperbolic compensation, Elliptical compensation, Circular compensation, Conic compensation, Inclination (Entire, Arbitrary), Polynomial compensation						
Contour analysis	Dedicated data processor type: Area, Circle, Angle, Coordinate difference, Step, Inclination PC system type (SURFPAK-EZ): Area, Circle, Angle, Coordinate difference, Step, Inclination						
Filters	Dedicated data processor type: 2CR-75%, 2CRPC-75%, Gaussian, Robust-spline PC system type: 2CR-75%, 2CR-50%, 2CRPC-75%, 2CRPC-50%, Gaussian, Rubust-spline						
Base size (width x depth)	—	23.6" x 17.7" (600x450mm)			39.4" x 17.7" (1000x450mm)	—	
Base material	Granite						
External dimensions (W x D x H)	Main unit	16.7" x 3.7" x 6.3" (425x94x160mm)	28.2" x 17.7" x 34" (716x450x863mm)	30.16" x 17.7" x 38" (766x450x966mm)	30.16" x 17.7" x 45.9" (766x450x1166mm)	45.9" x 17.7" x 46.3" (1166x450x1176mm)	16.7" x 3.7 x 6.3" (425x94x160mm)
	Display unit	12.9" x 10.63" x 4.38 (330x270x124mm)					—
	Electronic unit	—	—	14.6" x 9.65" x 2.83" (372x245x71.8mm)			—
	PC I/F unit	—	—	—	—	—	13.7" x 10.4" x 3.4" 350x263x86mm
Mass	Main unit	5.9 lbs (2.7kg)	308.6 lbs (140kg)	308.6 lbs (140kg)	330.7 lbs (150kg)	485 lbs (220kg)	5.91 lbs (2.7kg)
	Display unit	8.8 lbs (4.0kg)					—
	Electronic unit	—	—	6.6 lbs (3.0kg)			—

# Dimensions

Unit: mm  
25.4mm = 1"

**SJ-500**

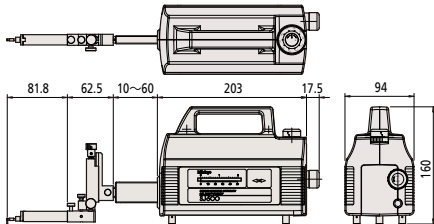

**Dedicated data processor**

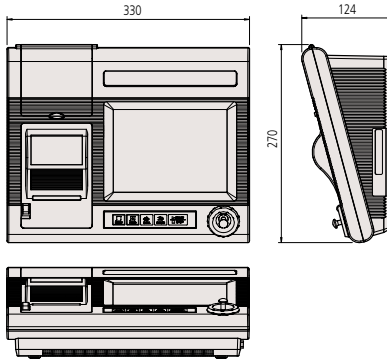

**Electronic unit**

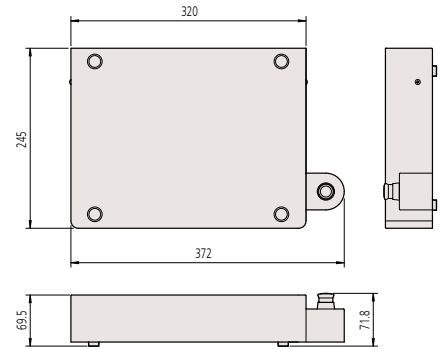

Only for SV-2100S4 / H4 / W4

**SV-2100M4**

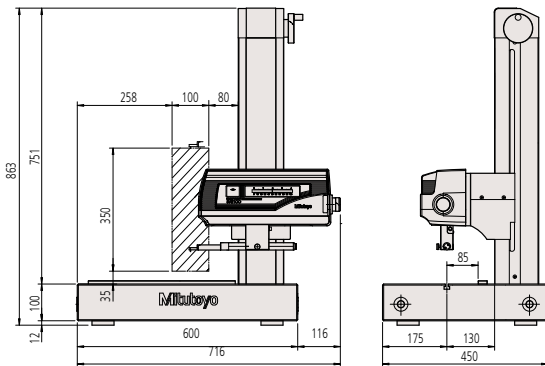

**SV-2100S4 / SV-2100H4**

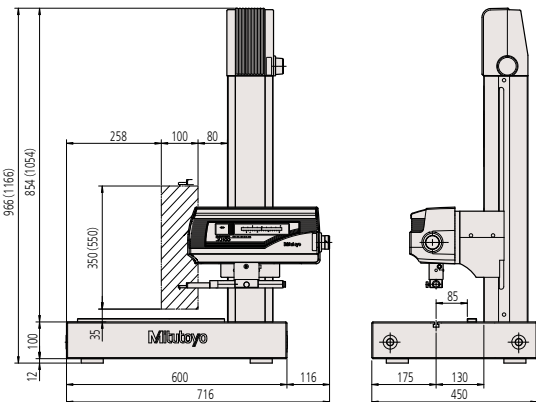

( ) : SV-2100H4

**SV-2100W4**

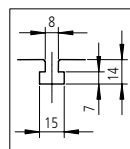
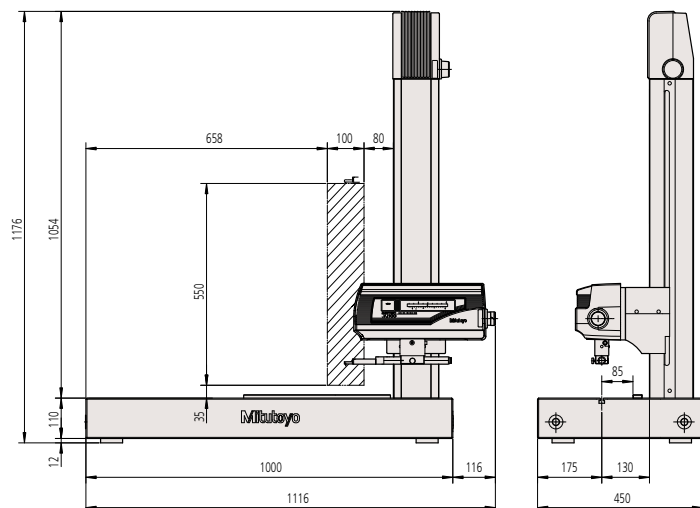

T-groove dimensions  
(common to SV-2100 Series)



Measuring range

# Optional Accessories

## Manual column stand: 178-085 (for SJ-500)

Suitable for desktop use in inspection rooms and such.

**No.178-085** \* Except measuring unit  
 Vertical adjustment range: 11.8" (300mm)  
 Dimension (W x D x H): 23.6" x 17.7" x 28"  
 (600 x 450 x 710mm)  
 Weight: 242 lbs (110kg)



Dimensions of SJ-500 with manual column stand Unit: mm

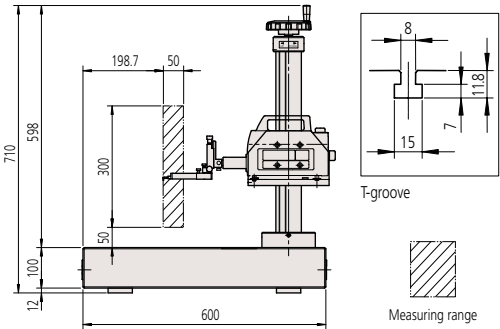

## Simple column stand: 178-089 (for SJ-500)

A portable simple column stand.

**178-089** Except for measuring unit  
 Vertical adjustment range: 250 mm  
 Dimension (WxDxH): 400x250x578.6 mm  
 Mass: 20 kg



Dimension of **SJ-500** with simple column stand Unit: mm

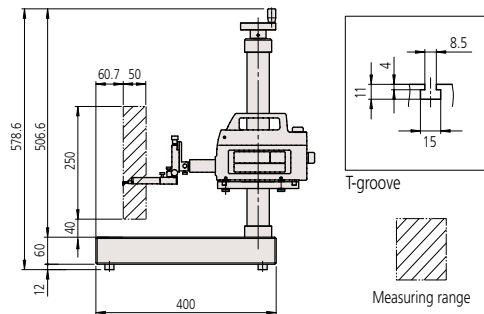

## Auto-leveling table: 178-081 (for SJ-500 / SV-2100M4), 178-083 (for SV-2100S4 / H4 / W4)

This is a stage that performs fully automatic leveling as measurement starts, freeing the user from this tedious operation. Fully automatic leveling can be done quickly by anyone. In addition, the operation is easy and reliable.



Inclination adjustment angle	±2°
Maximum load	15.4 lbs (7kg)
Table dimensions	5.12" x 3.94" (130x100mm)
Mass	7.7lbs (3.5kg)



## DAT leveling table: 178-048



Inclination adjustment angle	±1.5°
Maximum load	33 lbs. (15kg)
Table dimensions	5.12" x 3.94" (130x100mm)

This table can be used by itself or in conjunction with other leveling tables.

## Leveling table: 178-043-1 / 178-053-1 (with analog heads) 178-042-1 / 178-052-1 (with digital heads)



No.178-043-1



No.178-042-1

Order No.	178-043-1 (mm) 178-053-1 (in)	178-042-1 (mm) 178-052-1 (in)
Table dimensions	5.12" x 3.94" (130x100mm)	
Maximum load	33 lbs (15kg)	
Inclination adjustment. angle	±1.5°	
Swiveling angle	±3°	
XY-axis travel range	±0.49" (±12.5mm)	
Resolution	0.01mm	0.001mm
Dimensions	8.66" x 7.4" x 3.27" (220x189x83mm)	10.3" x 9.17 x 3.27" (262x233x83mm)
Mass	13.2 lbs (6Kg)	13.9 lbs (6.3Kg)

# Optional Accessories

## 3-axis adjustment table: 178-047

This table helps make the alignment adjustments required when measuring cylindrical surfaces. The corrections for the pitch angle and the swivel angle are determined from a preliminary measurement and the Digimatic micrometers are adjusted accordingly. A flat-surfaced workpiece can also be leveled with this table.



Inclination adjustment angle	±1.5°
Swiveling angle	±2°
Y-axis range	0.49" ±(12.5mm)
Resolution of heads	0.001mm
Table dimensions	5.12" x 3.94" (130x100mm)
Maximum load	33 lbs (15kg)

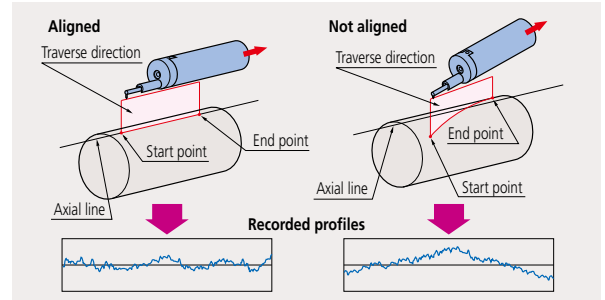

## System configuration including optional accessories (for SV-2100M4 / S4 / H4 / W4)

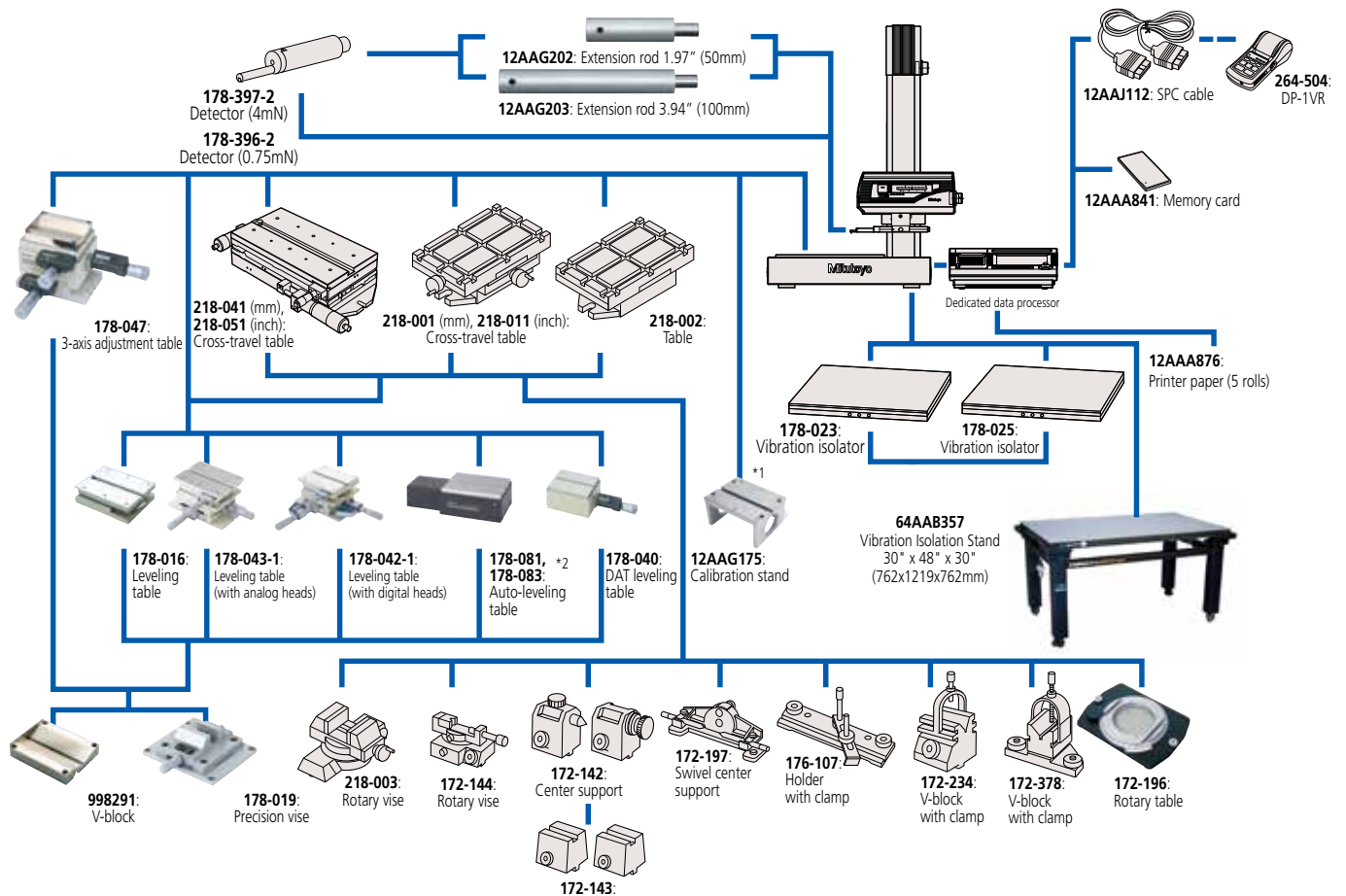

# Optional Accessories

## System configuration including optional accessories (for SJ-500 with optional manual column stand)

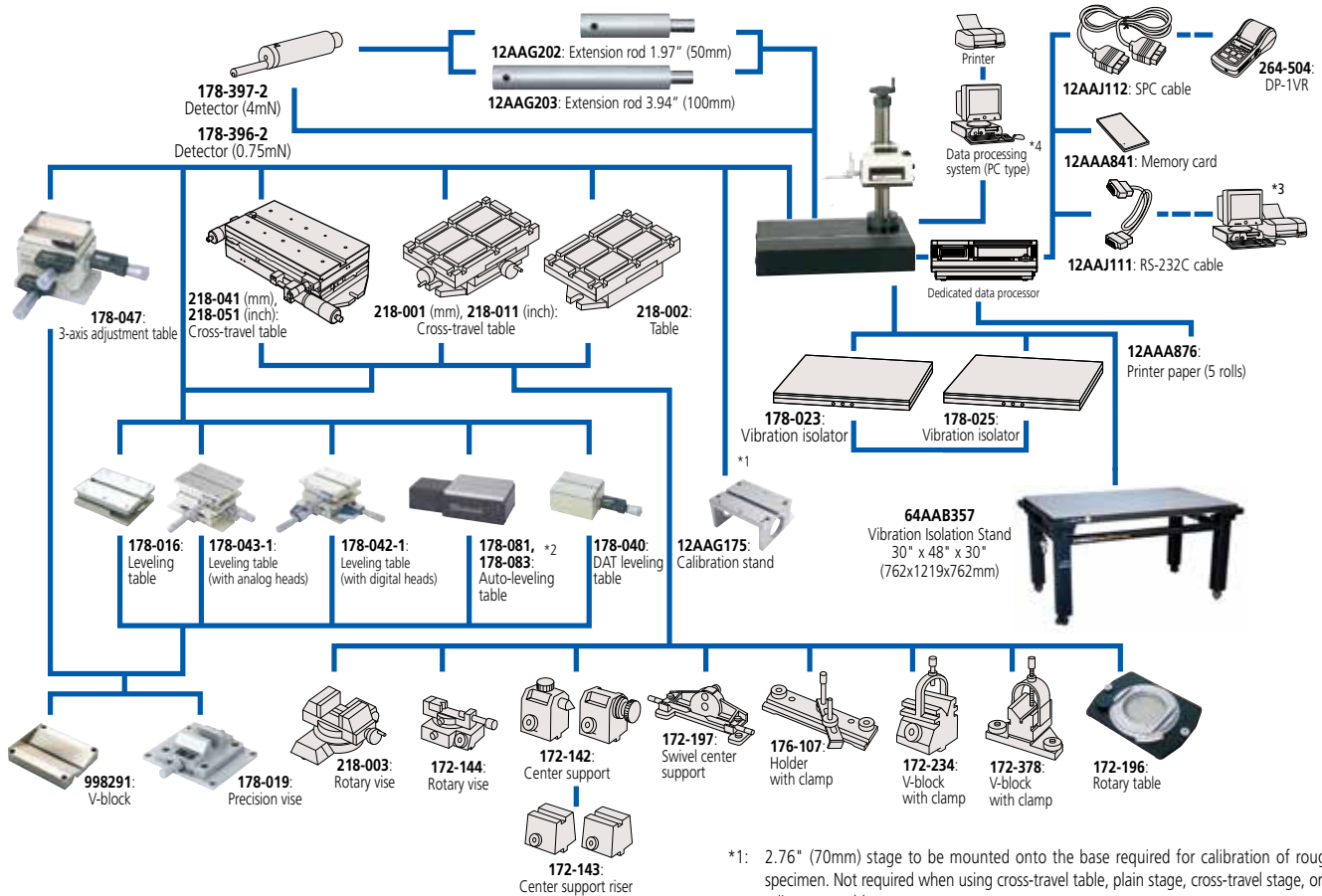

\*1: 2.76" (70mm) stage to be mounted onto the base required for calibration of roughness specimen. Not required when using cross-travel table, plain stage, cross-travel stage, or 3-axis adjustment table.

\*3: PC for managing the analysis result externally output from the dedicated data processor.

\*3: Only SJ-500P can be connected. Use a USB cable when connecting the SJ-500P main unit and a PC. A USB cable is a standard accessory of the SJ-500P.

### Roughness specimen (standard accessory): 178-601

Display	Ra = about 3 μm
Material	Ni (TiN surface coating)



### Reference step specimen: 178-611 (mm), 178-612 (inch)

For sensitivity calibration of detector

Nominal value of step	2μm 10μm, 79μm 394μm
-----------------------	----------------------

### Roughness specimen: 178-604

For checking stylus tip

Display	Ra = about 3 μm, about 0.4 μm
---------	-------------------------------



# Optional Styli

Unit: mm  
25.4mm = 1"

## Detectors

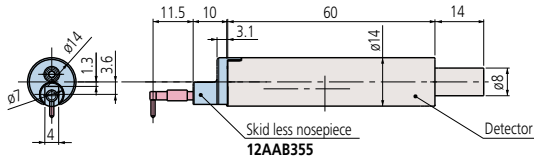

Detector (0.75mN): **178-396-2**  
Detector (4mN): **178-397-2**

## Extension rods



Extension rods  
(**12AAG202**: 1.97" (50mm), **12AAG203**: 3.94" (100mm))

## Styli

### Standard stylus

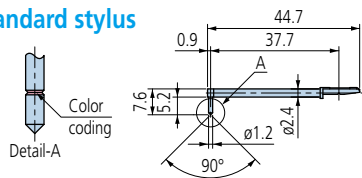

**12AAE882** (1μm)\*  
**12AAE924** (1μm)\*\*  
**12AAC731** (2μm)\*  
**12AAB403** (5μm)\*\*  
**12AAB415** (10μm)\*\*  
**12AAE883** (250μm)  
( ): Tip radius  
\*Tip angle: 60° \*\*Tip angle: 90°

### Double-length for deep hole

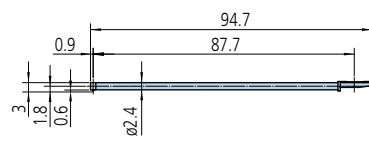

**12AAE898** (2μm)\*  
**12AAE914** (5μm)\*\*  
( ): Tip radius  
\*Tip angle: 60°  
\*\*Tip angle: 90°

### For small hole

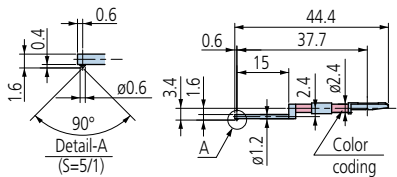

**12AAC732** (2μm)\*  
**12AAB404** (5μm)\*\*  
**12AAB416** (10μm)\*\*  
( ): Tip radius  
\*Tip angle: 60° \*\*Tip angle: 90°

### For small hole/Double-length for deep hole

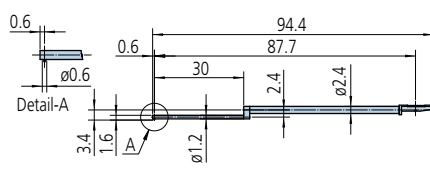

**12AAE892** (2μm)\*  
**12AAE908** (5μm)\*\*  
( ): Tip radius  
\*Tip angle: 60°  
\*\*Tip angle: 90°

### For very small hole

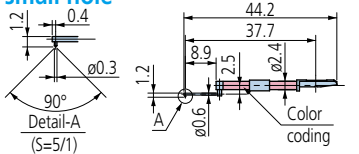

**12AAC733** (2μm)\*  
**12AAB405** (5μm)\*\*  
**12AAB417** (10μm)\*\*  
( ): Tip radius  
\*Tip angle: 60° \*\*Tip angle: 90°

### For very small hole

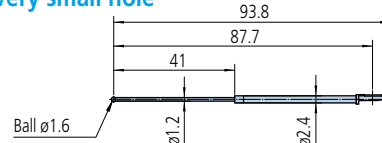

**12AAE884** (0.8mm)  
( ): Tip radius

### For extra small hole

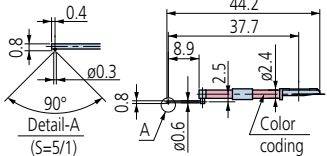

**12AAC734** (2μm)\*  
**12AAB406** (5μm)\*\*  
**12AAB418** (10μm)\*\*  
( ): Tip radius  
\*Tip angle: 60° \*\*Tip angle: 90°

### For ultra small hole

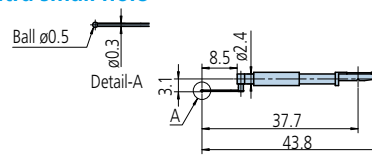

**12AAJ662** (0.25mm)  
( ): Tip radius

### For deep hole (double-length and triple-length)

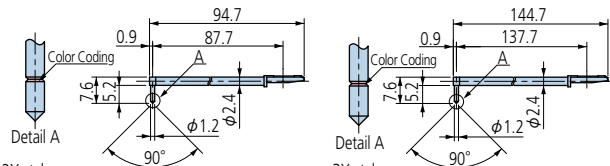

2X stylus  
**12AAC740** (2μm)\* ( ): Tip radius  
**12AAB413** (5μm)\*\* \*Tip angle: 60°  
**12AAB425** (10μm)\*\* \*\*Tip angle: 90°  
3X stylus  
**12AAC741** (2μm)\* ( ): Tip radius  
**12AAB414** (5μm)\*\* \*Tip angle: 60°  
**12AAB426** (10μm)\*\* \*\*Tip angle: 90°

### For small slotted hole

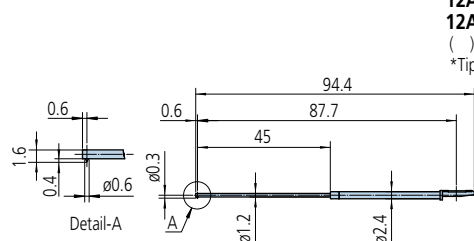

**12AAE938** (2μm)\*  
**12AAE940** (5μm)\*\*  
( ): Tip radius  
\*Tip angle: 60° \*\*Tip angle: 90°

Customized special interchangeable styli are available on request,  
Please contact any Mitutoyo office for more information.

Tip radius	1μm	2μm	5μm	10μm	250μm
Color coding	White	Black	No color	Yellow	No notch or color

Styli

For deep groove (10mm)

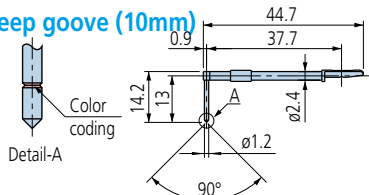

**12AAC735** (2μm)\*  
**12AAB409** (5μm)\*\*  
**12AAB421** (10μm)\*\*  
 ( ): Tip radius  
 \*Tip angle: 60°  
 \*\*Tip angle: 90°

For deep groove (20mm)/Double-length for deep hole

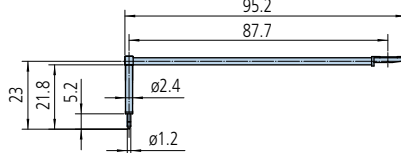

**12AAE893** (2μm)\*  
**12AAE909** (5μm)\*\*  
 ( ): Tip radius  
 \*Tip angle: 60°  
 \*\*Tip angle: 90°

For deep groove (20mm)

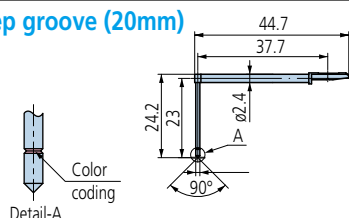

**12AAC736** (2μm)\*  
**12AAB408** (5μm)\*\*  
**12AAB420** (10μm)\*\*  
 ( ): Tip radius  
 \*Tip angle: 60°  
 \*\*Tip angle: 90°

For deep groove (40mm)

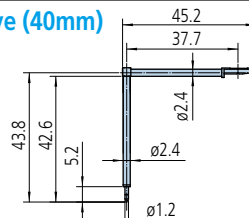

**12AAE895** (2μm)\*  
**12AAE911** (5μm)\*\*  
 ( ): Tip radius  
 \*Tip angle: 60°  
 \*\*Tip angle: 90°

For deep groove (30mm)

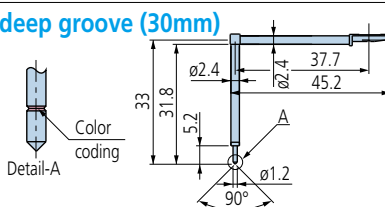

**12AAC737** (2μm)\*  
**12AAB407** (5μm)\*\*  
**12AAB419** (10μm)\*\*  
 ( ): Tip radius  
 \*Tip angle: 60°  
 \*\*Tip angle: 90°

For deep groove (30mm)/Double-length for deep hole

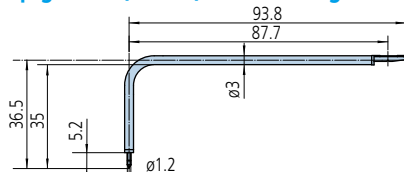

**12AAE894** (2μm)\*  
**12AAE910** (5μm)\*\*  
 ( ): Tip radius  
 \*Tip angle: 60°  
 \*\*Tip angle: 90°

For gear tooth

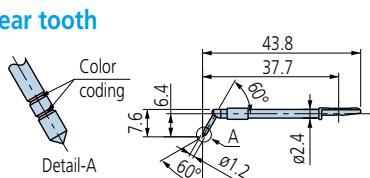

**12AAB737** (2μm)\*  
**12AAB410** (5μm)\*\*  
**12AAB422** (10μm)\*\*  
 ( ): Tip radius  
 \*Tip angle: 60° \*\*Tip angle: 90°

For gear tooth/Double-length for deep hole

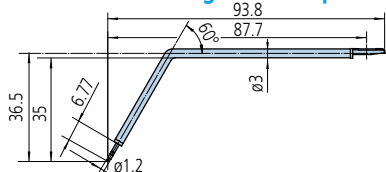

**12AAE896** (2μm)\*  
**12AAE912** (5μm)\*\*  
 ( ): Tip radius

For rolling circle waviness surface

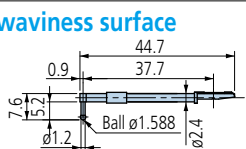

**12AAB338** (φ1.588)  
 ( ): Tip radius

For rolling circle waviness/Double-length for deep hole

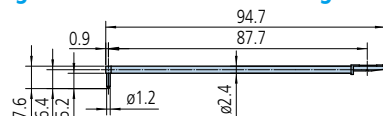

**12AAE886** (250μm)  
 ( ): Tip radius

For knife-edge detector

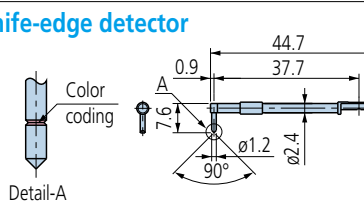

**12AAC738** (2μm)\*  
**12AAB411** (5μm)\*\*  
**12AAB423** (10μm)\*\*  
 ( ): Tip radius  
 \*Tip angle: 60°  
 \*\*Tip angle: 90°

For corner hole/Double-length for deep hole

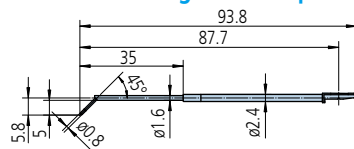

**12AAE897** (2μm)\*  
**12AAE913** (5μm)\*\*  
 ( ): Tip radius  
 \*Tip angle: 60°  
 \*\*Tip angle: 90°

For eccentric arm

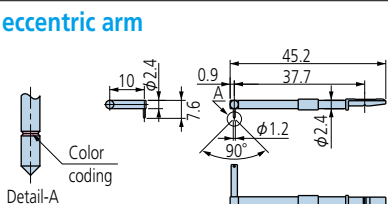

**12AAC739** (2μm)\*  
**12AAB412** (5μm)\*\*  
**12AAB424** (10μm)\*\*  
 ( ): Tip radius  
 \*Tip angle: 60°  
 \*\*Tip angle: 90°

For bottom surface

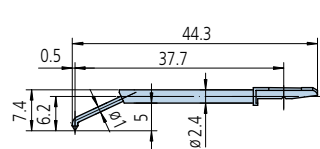

**12AAE899** (2μm)\*  
**12AAE915** (5μm)\*\*  
 ( ): Tip radius  
 \*Tip angle: 60°  
 \*\*Tip angle: 90°

Customized special interchangeable styli are available on request, Please contact any Mitutoyo office for more information.

Tip radius	2μm	5μm	10μm
Color coding	Black	No color	Yellow

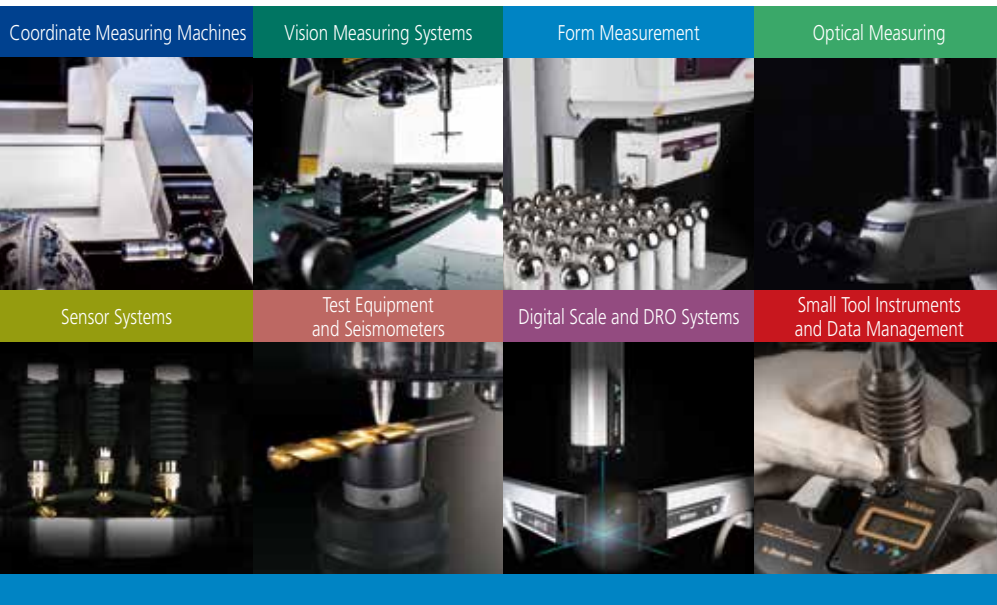

**Whatever your challenges are,  
Mitutoyo supports you from start to finish.**

Mitutoyo is not only a manufacturer of top-quality measuring products but one that also offers qualified support for the lifetime of the equipment, backed by comprehensive services that ensure your staff can make the very best use of the investment.

Apart from the basics of calibration and repair, Mitutoyo offers product and metrology training, as well as IT support for the sophisticated software used in modern measuring technology. We can also design, build, test and deliver measuring solutions and even, if deemed cost-effective, take your critical measurement challenges in-house on a sub-contract basis.



**Mitutoyo America Corporation**  
www.mitutoyo.com  
One Number to Serve You Better  
1-888-MITUTOYO (1-888-648-8869)

**M<sup>3</sup> Solution Centers:**  
Aurora, Illinois (Headquarters)  
Boston, Massachusetts  
Charlotte, North Carolina  
Cincinnati, Ohio  
Detroit, Michigan  
Los Angeles, California  
Seattle, Washington  
Houston, Texas



**Find additional product literature  
and our product catalog**

[www.mitutoyo.com](http://www.mitutoyo.com)

**Note:** All information regarding our products, and in particular the illustrations, drawings, dimensional and performance data contained in this printed matter as well as other technical data are to be regarded as approximate average values. We therefore reserve the right to make changes to the corresponding designs. The stated standards, similar technical regulations, descriptions and illustrations of the products were valid at the time of printing. In addition, the latest applicable version of our General Trading Conditions will apply. Only quotations submitted by ourselves may be regarded as definitive. Specifications are subject to change without notice.

Mitutoyo products are subject to US Export Administration Regulations (EAR). Re-export or relocation of our products may require prior approval by an appropriate governing authority.

**Trademarks and Registrations**

Designations used by companies to distinguish their products are often claimed as trademarks. In all instances where Mitutoyo America Corporation is aware of a claim, the product names appear in initial capital or all capital letters. The appropriate companies should be contacted for more complete trademark and registration information.