

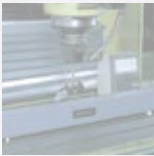

## Gage Blocks



## Height Master



## Reference Gages



## Granite Surface Plates & Bench Comparator



## CERA/Steel Combination Gage Block Sets



## Step Master



## ZERO CERA BLOCK



## Ceramic Straight Master

## INDEX

<b>Gage Blocks</b>	E-2-4
Metric Rectangular Gage Block Set	E-5,6
Inch Rectangular Gage Block Set	E-7
Micrometer Inspection Gage Block Sets	E-8
Bore Gage Calibration Kit	E-8
Individual Metric Rectangular Gage Block	E-9,10
Individual Inch Rectangular Gage Block	E-11
Rectangular Gage Block with CTE	E-12
Zero CERA Blocks	E-12
Rectangular Gage Block Accessories	E-13-15
Metric Square Gage Block Set	E-16
Inch Square Gage Block Set	E-17
Individual Metric Square Gage Block	E-18
Individual Inch Square Gage Block	E-19
Square Gage Block Accessories	E-20,21
Ceraston	E-22
Maintenance Kit for Gage Block	E-22
Step Master	E-23
Made-to-Order Block & Reference	E-23
Gage Block Comparator GBCD-250	E-24
Gage Block Comparator GBCD-100A	E-24
<b>Height Masters</b>	
Height Master	E-25
Digital Height Master	E-26
Riser Blocks	E-27
Auxiliary Block Kit	E-27
Universal Height Master	E-28
High-Accuracy Check Master HMC-H	E-29
CERA Straight Master SM-C	E-30
Square Master	E-31
<b>Reference Gages</b>	
Standard Scales	E-32
Working Standard Scales	E-32
High-Precision Square	E-33
Spring Dividers and Calipers	E-33
Steel Rules	E-34,35
Semi-Flexible Rules	E-35
Thickness/Feeler Gages	E-36
Precision Levels	E-36
Digital Universal Protractor	E-37
Universal Bevel Protractor	E-38
Bevel Protractor	E-38
Radius Gages	E-39
Pitch Gages	E-39
Radius Gages-Sets	E-40
Digital Protractor	E-41
Digital Hand Tachometers	E-42
Bench Center	E-43
<b>Granite Surface Plates</b>	
Granite Surface Plate Accessories	E-43
Black Granite Surface Plate	E-44,45
Steel Stands	E-45

# Gage Block

## SERIES 516

### FEATURES

Precision gage blocks are the primary standards vital to dimensional quality control in the manufacture of parts. Mitutoyo offers

a complete selection of gage blocks available in a choice of rectangular or square, metric or inch and steel or CERA (ceramic) types.

### Accuracy

Mitutoyo gage blocks guarantee such a high accuracy that users can use them without anxiety. Mitutoyo has established a traceability system for our measurement products, up to the Metrology Management Center of the National Institute of Advanced Industrial Science and Technology (AIST), and we have been certified by the Japanese government as an accredited laboratory.

### Wringing

The lapping technique is one of Mitutoyo's specialties. Our advanced lapping technique, developed for more than a half century, allows us to achieve the best flatness and surface roughness needed for gage blocks.

### Abrasion Resistance and Dimensional Stability

High-carbon, high-chrome steel is employed to sufficiently satisfy a variety of material characteristics required for gage blocks. A high degree of hardness, obtained by our heat treatment technology, as well as methodically repeated heat treatment, have successfully reduced deterioration change over time.

### CERA Blocks

CERA blocks, made of ceramic materials with superior surface quality, were developed by Mitutoyo's ultra-precision machining techniques and solve problems commonly associated with steel gage blocks.

#### 1. Corrosion-Resistant

Anti-corrosion treatment is not required when handled normally (i.e. with fingers), resulting in simple maintenance and storage.

#### 2. No Burrs Caused by Dents, etc.

Since the CERA Block is very hard it will not scratch and is highly resistant to burrs. If a burr is formed, it can easily be removed with a ceramic deburring stone (Ceraston).

#### 3. Abrasion Resistant

CERA Blocks have 10 times the abrasion resistance of steel gage blocks.

#### 4. Dimensional Stability

CERA Blocks are free from dimensional change over time.

#### 5. Marking

The black characters, indicating the nominal length, are inscribed by laser and are clearly visible against the white surface of the block.

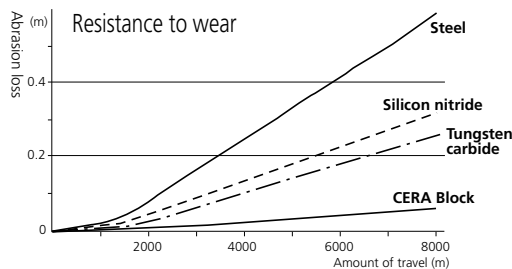

### Selecting Gage Blocks

- Select gage blocks in accordance with the combination range required. If a large length is required, add a long block set.
- Select gage blocks in accordance with the minimum length step required. Add wear block sets if necessary.
- If a set containing a large number of gage blocks is selected, the number of combination gage blocks required for a length is reduced and the number of combinations is increased. The accuracy will be retained and damage will be reduced.
- The specific gage block set for micrometer inspection and caliper inspection is available.
- If using only one length repeatedly, it is a good idea to purchase discrete gage blocks.
- The 2mm-based gage blocks, which take the base of the minimum length step as 2mm, are easy to handle and will not warp, as compared to the 1mm-based gage blocks.

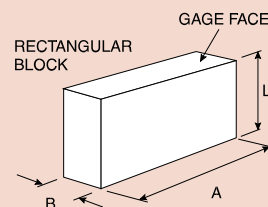

### Rectangular Block

Gage Size	Face Width (A)	Face Depth (B)
Up to 2"	1.181"	.355"
Over .2" up to 40"	1.378"	.355"
Up to 10mm	30mm	9mm
Over 10mm up to 1000mm	35mm	9mm

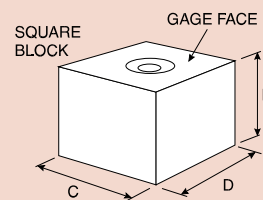

### Square Block

Gage Size	Face Width (C)	Face Depth (D)
Inch (up to 40")	.95"	.95"
Metric (up to 1000mm)	24.1mm	24.1mm

## Grade and Application

Refer to the following table to select the gage block grade according to usage.

	Applications	Grade
Workshop use	• Mounting tools and cutters	AS-1 or AS-2
	• Manufacturing gages • Calibrating instruments	0 or AS-1
Inspection use	• Inspecting mechanical parts, tools, etc.	0 or AS-1
	• Checking the accuracy of gages • Calibrating instruments	00 or 0
Calibration use	• Checking the accuracy of gage blocks for workshop • Checking the accuracy of gage blocks for inspection • Checking the accuracy of instruments	K or 00
Reference use	• Checking the accuracy of gage blocks for calibration • For academic research	K

### Grade AS-1:

These gage blocks are intended for shop-floor use to set and calibrate fixtures, as well as precision instruments.

### Grade 0:

This grade is used within an inspection area to verify the accuracy of plug and snap gages, as well as for setting electronic measuring devices.

### Grade 00:

These higher accuracy gages are intended for use within a controlled environment by skilled inspection staff. Mainly used as reference standards for setting high-precision measuring equipment and for the calibration of lower grade gage blocks.

### Grade K:

Gage blocks of this accuracy are intended for use within a temperature-controlled inspection room or calibration laboratory. They should be used as masters with certificates against other gage blocks which are calibrated by comparison.

### Combination of a Required Length

Multiple combinations of gage blocks can be used to make a required length. Care should be exercised in the following points.

1. Use as few gage blocks as possible to obtain the required length. (Select thick gage blocks whenever possible.)
2. Select gage blocks starting with the one that has the least significant digit required, and then work up to ones with more significant digits.
3. There are multiple combinations for the integer part of a length. To prevent wear as much as possible, do not always use the same gage blocks.

Example combination

Required length = 45.6785mm

#### For the 1mm-based gage block set (112 pcs.)

```

1.005
1.008
1.17
17.5
+ 25
-----
45.6785mm
    
```

#### For the 2mm-based gage block set (112 pcs.)

```

2.005
2.008
2.17
14.5
+ 25
-----
45.6785mm
    
```

## 6. Anti-magnetic Nature Keeps Away Steel Powders

## 7. High Wringing Force

An even, dense tissue can maintain a strong wringing force.



## 8. Material of CERA block

Property	Material	CERA Block (ZrO <sub>2</sub> )	Steel (Fe)	Carbide (WC-Co)	Silicon nitride (Si <sub>3</sub> N <sub>4</sub> )
Hardness (HV)		1350	800	1650	1500
Coefficient of thermal expansion (10 <sup>-6</sup> /K)		9.3±0.5	10.8±0.5	5.5±1.0	2
Flexural strength by 3-point bending (MPa)		1270	1960	1960	580
Fracture toughness K1c (MPa•m <sup>1/2</sup> )		7	120	12	6.5
Young's Modulus x104 (MPa)		20.6	20.6	61.8	28.4
Poisson's Ratio		0.3	0.3	0.2	0.3
Specific gravity		6.0	7.8	14.8	3.2
Thermal conductivity (W/m•k)		2.9	54.4	79.5	16.7

## 9. Closest Expansion Coefficient to Steel

The thermal expansion coefficient of a CERA Block is similar to that of a steel gage block.

## 10. Highly Resistant Against Drops and Other Shocks

The CERA block material is one of the toughest ceramics materials. It is extremely difficult to crack under normal use.

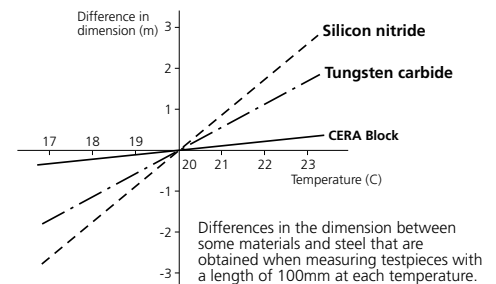

## Features of Square Gage Blocks

### 1. Perfect wringing is possible using the center hole.

After wringing the square gage blocks, an optional tie rod can be inserted through the center hole to fix the blocks using a screw.

### 2. A height reference standard can easily be made.

A precision height reference standard can be made easily and inexpensively using accessories such as the plain jaw and block base.

### 3. A dedicated inspection jig can be easily made.

A dedicated inspection jig for periodic inspection of instruments can be made easily and inexpensively.

### 4. A wide measuring surface with cross section dimensions of [24.1 x 24.1mm / .95 x .95"] is available.

A square gage block can retain stable orientation both longitudinally and laterally. A wide range of application measurements can be made, including cutting tool positioning, angle measurement with a sine bar, taper measurement with a roller, and inspection of depth micrometers.



## Long and Ultra-Thin Gage Blocks

Mitutoyo offers extra thin gage blocks from 0.10 mm to 0.99 mm (increments of 0.01 mm), as well as long gage blocks up to 1,000 mm as standard products.

# Gage Block

## SERIES 516

### Accuracies of Mitutoyo Gage Blocks

All Mitutoyo gage blocks meet or exceed all known specifications. The flatness, parallelism and surface finish necessary to achieve the required accuracies are the same as or better than government requirements.

### ASME (American Society of Mechanical Engineers) Deviations and Tolerance on Length for Metric and inch Gage Blocks: ASME B89.1.9-2002 (USA)

Nominal Length Range l <sub>n</sub> in inches	Calibration Grade K		Grade 00		Grade 0		Grade AS-1		Grade AS-2	
	Limit Deviations of Length at any Point From Nominal Length ± l <sub>e</sub> μin.	Tolerance for the Variation In Length l <sub>v</sub> μin.	Limit Deviations of Length at any Point From Nominal Length ± l <sub>e</sub> μin.	Tolerance for the Variation In Length l <sub>v</sub> μin.	Limit Deviations of Length at any Point From Nominal Length ± l <sub>e</sub> μin.	Tolerance for the Variation In Length l <sub>v</sub> μin.	Limit Deviations of Length at any Point From Nominal Length ± l <sub>e</sub> μin.	Tolerance for the Variation In Length l <sub>v</sub> μin.	Limit Deviations of Length at any Point From Nominal Length ± l <sub>e</sub> μin.	Tolerance for the Variation In Length l <sub>v</sub> μin.
l <sub>n</sub> ≤ .05	12	2	4	2	6	4	12	6	24	12
.05 l <sub>n</sub> ≤ .4	10	2	3	2	5	4	8	6	18	12
.45 l <sub>n</sub> ≤ 1	12	2	3	2	6	4	12	6	24	12
1 l <sub>n</sub> ≤ 2	16	2	4	2	8	4	16	6	32	12
2 l <sub>n</sub> ≤ 3	20	2	5	3	10	4	20	6	40	14
3 l <sub>n</sub> ≤ 4	24	3	6	3	12	5	24	8	48	14
4 l <sub>n</sub> ≤ 5	32	3	8	3	16	5	32	8	64	16
5 l <sub>n</sub> ≤ 6	32	3	8	3	16	5	32	8	64	16
6 l <sub>n</sub> ≤ 7	40	4	10	4	20	6	40	10	80	16
7 l <sub>n</sub> ≤ 8	40	4	10	4	20	6	40	10	80	16
8 l <sub>n</sub> ≤ 10	48	4	12	4	24	6	48	10	104	18
10 l <sub>n</sub> ≤ 12	56	4	14	4	28	7	56	10	112	20
12 l <sub>n</sub> ≤ 16	72	5	18	5	36	8	72	12	144	20
16 l <sub>n</sub> ≤ 20	88	6	20	6	44	10	88	14	176	24
20 l <sub>n</sub> ≤ 24	104	6	25	6	52	10	104	16	200	28
24 l <sub>n</sub> ≤ 28	120	7	30	7	60	12	120	18	240	28
28 l <sub>n</sub> ≤ 32	136	8	34	8	68	12	136	20	260	32
32 l <sub>n</sub> ≤ 36	152	8	38	8	76	14	152	20	300	36
36 l <sub>n</sub> ≤ 40	160	10	40	10	80	16	168	24	320	40

Nominal Length Range l <sub>n</sub> in mm	Calibration Grade K		Grade 00		Grade 0		Grade AS-1		Grade AS-2	
	Limit Deviations of Length at any Point From Nominal Length ± l <sub>e</sub> μm	Tolerance for the Variation In Length l <sub>v</sub> μm	Limit Deviations of Length at any Point From Nominal Length ± l <sub>e</sub> μm	Tolerance for the Variation In Length l <sub>v</sub> μm	Limit Deviations of Length at any Point From Nominal Length ± l <sub>e</sub> μm	Tolerance for the Variation In Length l <sub>v</sub> μm	Limit Deviations of Length at any Point From Nominal Length ± l <sub>e</sub> μm	Tolerance for the Variation In Length l <sub>v</sub> μm	Limit Deviations of Length at any Point From Nominal Length ± l <sub>e</sub> μm	Tolerance for the Variation In Length l <sub>v</sub> μm
l <sub>n</sub> ≤ 0.5	0.30	0.05	0.10	0.05	0.14	0.10	0.30	0.16	0.60	0.30
0.5 l <sub>n</sub> ≤ 10	0.20	0.05	0.07	0.05	0.12	0.10	0.20	0.16	0.45	0.30
10 l <sub>n</sub> ≤ 25	0.30	0.05	0.07	0.05	0.14	0.10	0.30	0.16	0.60	0.30
25 l <sub>n</sub> ≤ 50	0.40	0.06	0.10	0.06	0.20	0.10	0.40	0.18	0.80	0.30
50 l <sub>n</sub> ≤ 75	0.50	0.06	0.12	0.06	0.25	0.12	0.50	0.18	1.00	0.35
75 l <sub>n</sub> ≤ 100	0.60	0.07	0.15	0.07	0.30	0.12	0.60	0.20	1.20	0.35
100 l <sub>n</sub> ≤ 150	0.80	0.08	0.20	0.08	0.40	0.14	0.80	0.20	1.60	0.40
150 l <sub>n</sub> ≤ 200	1.00	0.09	0.25	0.09	0.50	0.16	1.00	0.25	2.00	0.40
200 l <sub>n</sub> ≤ 250	1.20	0.10	0.30	0.10	0.60	0.16	1.20	0.25	2.40	0.45
250 l <sub>n</sub> ≤ 300	1.4	0.10	0.35	0.10	0.70	0.18	1.40	0.25	2.80	0.50
300 l <sub>n</sub> ≤ 400	1.80	0.12	0.45	0.12	0.90	0.20	1.80	0.30	3.60	0.50
400 l <sub>n</sub> ≤ 500	2.20	0.14	0.50	0.14	1.10	0.25	2.20	0.35	4.40	0.60
500 l <sub>n</sub> ≤ 600	2.60	0.16	0.65	0.16	1.30	0.25	2.60	0.40	5.00	0.70
600 l <sub>n</sub> ≤ 700	3.00	0.18	0.75	0.18	1.50	0.30	3.00	0.45	6.00	0.70
700 l <sub>n</sub> ≤ 800	3.40	0.20	0.85	0.20	1.70	0.30	3.40	0.50	6.50	0.80
800 l <sub>n</sub> ≤ 900	3.80	0.20	0.95	0.20	1.90	0.35	3.80	0.50	7.50	0.90
900 l <sub>n</sub> ≤ 1000	4.20	0.25	1.00	0.25	2.00	0.40	4.20	0.60	8.00	1.00

### Mitutoyo Gage Blocks and Inspection Certificates

A Certificate of Inspection is furnished with all Mitutoyo gage blocks with a serial number on the case and an identification number on each block. The deviation of each block is registered. For this inspection, each gage block is measured relative to the upper level master using a gage block comparator. Grade K gage blocks are manufactured by absolute measurement using an interferometer. The gage block set and discrete gage block are supplied with a Certificate of Calibration. The Certificate of Calibration specifies the deviation from the nominal length. (Comparative measurement, however, is performed for all square gage blocks.)

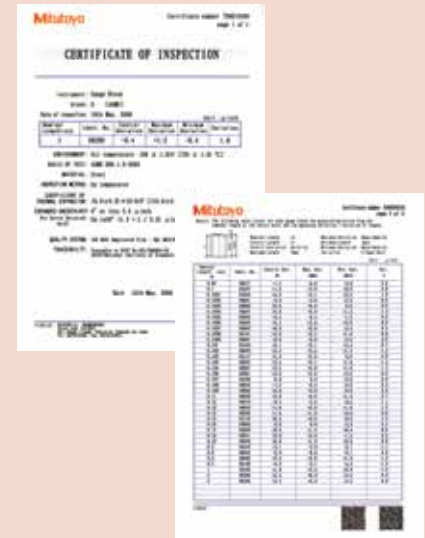

A Certificate of Accuracy, traceable to the NIST, is furnished with each gage block set and individual block.

### Mitutoyo America Corporation Calibration Laboratory:

ISO 17025-2005 accredited calibration available  
Calibration capability up to 1000mm/40" length  
Low measurement uncertainty

### Contact Information:

965 Corporate Blvd.  
Aurora, Illinois 60502  
Phone: (888) 648-8869 option 7  
Fax: (630) 978-6477

# Metric Rectangular Gage Block Set

## SERIES 516 — 1mm Base Block Set



Steel 112-block set



Steel 103-block set



Steel 47-block set



CERA 112-block set



CERA 56-block set



CERA/Steel combination  
47-block set

Provided with Inspection Certificate



### SPECIFICATIONS

#### 1mm Base Block Set

Blocks per set	Order No.		Grade	Blocks included in set		
	Steel	CERA		Size	Step	Qty.
112	516-531-56	516-541-56	K	1.0005		1
	516-937-26	516-337-26	00	1.001 - 1.009	0.001	9
	516-938-26	516-338-26	0	1.01 - 1.49	0.01	49
	516-939-26	516-339-26	AS-1	0.5 - 24.5	0.5	49
	516-940-26	516-340-26	AS-2	25 - 100	25	4
	516-533-56	516-542-56	K	1.005		1
103	516-941-26	516-341-26	00	1.01 - 1.49	0.01	49
	516-942-26	516-342-26	0	0.5 - 24.5	0.5	49
	516-943-26	516-343-26	AS-1	25 - 100	25	4
	516-944-26	516-344-26	AS-2			
	516-535-56	515-543-56	K	1.001 - 1.009	0.001	9
	516-945-26	516-345-26	00	1.01 - 1.49	0.01	49
87	516-946-26	516-346-26	0	0.5 - 9.5	0.5	19
	516-947-26	516-347-26	AS-1	10 - 100	10	10
	516-948-26	516-348-26	AS-2			
	516-536-56	516-544-56	K	0.5		1
	516-953-26	516-353-26	00	1.001 - 1.009	0.001	9
	516-954-26	516-354-26	0	1.01 - 1.09	0.01	9
56	516-955-26	516-355-26	AS-1	1.1 - 1.9	0.1	9
	516-956-26	516-356-26	AS-2	1 - 24	1	24
				25 - 100	25	4
	516-537-56	516-545-56	K	1.005		1
	516-957-26	516-357-26	00	1.01 - 1.09	0.01	9
	516-958-26	516-358-26	0	1.1 - 1.9	0.1	9
47	516-959-26	516-359-26	AS-1	1 - 24	1	24
	516-960-26	516-360-26	AS-2	25 - 100	25	4



# Metric Rectangular Gage Block Set

**SERIES 516 — Long Block Set, Wear Block Set**



CERA 8-block set



Steel 8-block set

Provided with Inspection Certificate

## SPECIFICATIONS

### Long Block Set

Blocks per set	Order No.		Grade ASME	Blocks included in set		
	Steel	CERA		Size	Step	Qty.
8	—	516-547-56	K	25-200	25	8
	—	516-164-26	00	—	—	—
	516-115-26	516-165-26	0	—	—	—
	516-116-26	516-166-26	AS-1	—	—	—
8	516-540-56	516-546-56	K	125 - 175	25	3
	516-701-26	516-731-26	00	200 - 250	50	2
	516-702-26	516-732-26	0	300 - 500	100	3
	516-703-26	516-733-26	AS-1	—	—	—
	—	—	—	—	—	—



CERA 2-block set



Carbide 2-block

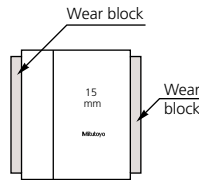

## SPECIFICATIONS

### Wear Block Set

Blocks per set	Order No.		Grade ASME	Blocks included in set	
	Carbide	CERA		Size	Qty.
2	516-807-26	516-832-26	0	1	2
	516-806-26	516-833-26	AS-1	—	—
	—	—	—	—	—
2	516-803-26	516-830-26	0	2	2
	516-802-26	516-831-26	AS-1	—	—

# Inch Rectangular Gage Block Set

**SERIES 516 — Inch Block Set, Thin Block Set, Long Block Set, Wear Block Set**

## SPECIFICATIONS

### Inch Block Set

Blocks per set	Order No.			Grade	Blocks included in set		
	Steel	CERA	Steel/CERA		Size	Step	Qty.
<b>81</b>	516-549-56	516-557-56	—	K	.1001 – .1009	.0001	9
	516-901-26	516-301-26	—	00	.101 – .149	.001	49
	516-902-26	516-302-26	—	0	.05 – .95	.05	19
	516-903-26	516-303-26	—	AS-1	1 - 4	1	4
	516-904-26	516-304-26	—	AS-2			
<b>35</b>	516-550-56	516-558-56	—	K	.10005		1
	516-913-26	516-313-26	—	00	.1001 – .1009	.0001	9
	516-914-26	516-314-26	—	0	.101 – .109	.001	9
	516-915-26	516-315-26	—	AS-1	.11 – .19	.01	9
	516-916-26	516-316-26	—	AS-2	.1 - .3	.1	3
					.5, 1, 2, 4		4

81-block set: All are CERA blocks, except 2", 3", and 4" are steel blocks

Provided with Inspection Certificate



## SPECIFICATIONS

### Thin Block Set

Blocks per set	Order No.		Grade	Blocks included in set		
	Steel	CERA		Size	Step	Qty.
<b>28</b>	516-551-56	—	K	.02005		1
	516-917-26	—	00	.0201 – .0209	.0001	9
	516-918-26	—	0	.021 – .029	.001	9
	516-919-26	—	AS-1	.01 – .09	.01	9
	516-920-26	—	AS-2			
<b>10</b>	516-926-26	—	0	.005 - .050	.005	10

## SPECIFICATIONS

### Long Block Set

Blocks per set	Order No.		Grade	Blocks included in set		
	Steel	CERA		Size	Step	Qty.
<b>8</b>	516-126-26	516-176-26	0	1-8	1	8
	516-127-26	516-177-26	AS-1			
<b>8</b>	—	516-564-56	K	5 - 7	1	3
	—	516-741-26	00	8, 10, 12	2	3
	516-712-26	516-742-26	0	16, 20	4	2
	516-713-26	516-743-26	AS-1			

## SPECIFICATIONS

### Wear Block Set

Blocks per set	Order No.		Grade	Blocks included in set	
	Carbide	CERA		Size	Qty.
<b>2</b>	516-809-26	516-836-26	0	.05	2
	516-808-26	516-837-26	AS-1		
<b>2</b>	516-805-26	516-834-26	0	.1	2
	516-804-26	516-835-26	AS-1		

# Micrometer Inspection Gage Block Sets

## SERIES 516

- Gage blocks for inspecting a variety of micrometers.
- Can be measured in both vertical and horizontal posture.
- Parallelism is measured by attaching the optional parallel (optional accessory) to the gage block set.

### SPECIFICATIONS

Metric  Micro Checker (holder only)	
<b>Order No.</b>	<b>516-607</b>
Applicable gage block set	516-106-26, 516-107-26, 516-156-26, 516-157-26
Applicable gage block size (mm)	2.5, 5.1, 7.7, 10.3, 12.9, 15, 17.6, 20.2, 22.8, 25

Inch/Metric  Micro Checker (holder only)	
<b>Order No.</b>	<b>516-608</b>
Applicable gage block set	516-921-26, 516-922-26, 516-923-26, 516-321-26, 516-322-26, 516-323-26
Applicable gage block size (inch)	.105, .210, .315, .420, .5, .605, .815, .920

Metric Block Set 				
Blocks per set	Order No.		Grade	Blocks included in set
	Steel	CERA		
10	516-103-26	516-152-26	0	1.00, 1.25, 1.50, 2, 3, 5, 10, 15, 20, 25mm
	516-101-26	516-153-26	AS-1	
10	516-106-26	516-156-26	0	2.5, 5.1, 7.7, 10.3, 12.9, 15, 17.6, 20.2, 22.8, 25mm • Optical parallel (t = 12mm)
	516-107-26	516-157-26	AS-1	

Inch Block Set 				
Blocks per set	Order No.		Grade	Blocks included in set
	Steel	CERA		
10	516-552-56	516-559-56	K	.105, .210, .315, .420, .500, .605, .710, .815, .920, 1" • Optical parallel (t = .5")
	516-921-26	516-321-26	00	
	516-922-26	516-322-26	0	
	516-923-26	516-323-26	AS-1	
10	516-529-26*	516-319-26*	0	.087, .189, .307, .409, .472, .598, .669, .772, .890, 1" • Optical parallel (t = .5")
9	516-554-56	516-561-56	K	.0625, .100, .125, .200, .250, .300, .500, 1, 2" • Optical parallel (t = .5")
	516-929-26	516-333-26	00	
	516-930-26	516-334-26	0	
	516-931-26	516-335-26	AS-1	
9	—	516-563-56	K	.0625, .100, .125, .200, .250, .300, .500, 1, 2"
	—	516-329-26	00	
	516-934-26	516-330-26	0	
	516-935-26	516-331-26	AS-1	

\* For QuantuMike

### Micro Checker



(Gage blocks are optional.)



Provided with Inspection Certificate

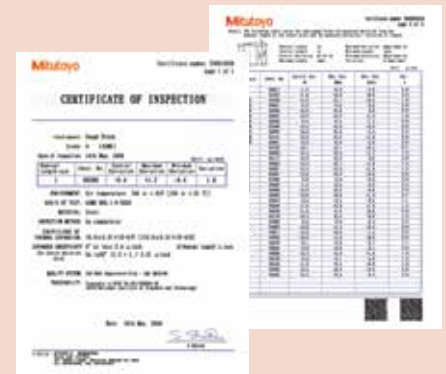

# Bore Gage Calibration Kit

## SERIES 516

### SPECIFICATIONS

Blocks per set	Order No.		Grade	Blocks included in set
	Carbide			
9	516-120-26		0	.04", .08", .16", .2", .4", .8", 1", 2", 3" 619018 (plain jaw 2 pc. set) and 619004 (160mm holder)



# Individual Metric Rectangular Gage Block

## FEATURES

- If using only one length repeatedly, it is good practice to purchase discrete gage blocks.
- Each gage block is supplied with a Certificate of Inspection.
- Each Grade K gage block of ASME standard is specially supplied with a Certificate of Calibration, which certifies that the gage block was manufactured via interferometry.



## Suffix Number for Selecting Standard and Certificate Provided

ASME	
Grade	Steel, CERA
K	-516**
00	-521*
0	-531*
AS-1	-541*
AS-2	-551*

\* provided with Inspection Certificate

\*\* provided with Calibration Certificate and Inspection Certificate

Example: 611821-521  
0.1mm gage block in grade 00.

We make custom length gage blocks:  
0.1-1000mm



Inspection Certificate

## SPECIFICATIONS

### Metric Block

Length (mm)	Order No.		Length (mm)	Order No.		Length (mm)	Order No.	
	Steel	CERA		Steel	CERA		Steel	CERA
0.1	611821	—	0.53	611894	—	0.96	611937	—
0.11	611860	—	0.54	611895	—	0.97	611938	—
0.12	611861	—	0.55	611896	—	0.98	611939	—
0.13	611862	—	0.56	611897	—	0.99	611940	—
0.14	611863	—	0.57	611898	—	0.991	611551	613551
0.15	611822	—	0.58	611899	—	0.992	611552	613552
0.16	611864	—	0.59	611900	—	0.993	611553	613553
0.17	611865	—	0.6	611901	—	0.994	611554	613554
0.18	611866	—	0.61	611902	—	0.995	611555	613555
0.19	611867	—	0.62	611903	—	0.996	611556	613556
0.2	611823	—	0.63	611904	—	0.997	611557	613557
0.21	611868	—	0.64	611905	—	0.998	611558	613558
0.22	611869	—	0.65	611906	—	0.999	611559	613559
0.23	611870	—	0.66	611907	—	1	611611	613611
0.24	611871	—	0.67	611908	—	1.0005	611520	613520
0.25	611824	—	0.68	611909	—	1.001	611521	613521
0.26	611872	—	0.69	611910	—	1.002	611522	613522
0.27	611873	—	0.7	611911	—	1.003	611523	613523
0.28	611874	—	0.71	611912	—	1.004	611524	613524
0.29	611875	—	0.72	611913	—	1.005	611525	613525
0.3	611825	—	0.73	611914	—	1.006	611526	613526
0.31	611876	—	0.74	611915	—	1.007	611527	613527
0.32	611877	—	0.75	611916	—	1.008	611528	613528
0.33	611878	—	0.76	611917	—	1.009	611529	613529
0.34	611879	—	0.77	611918	—	1.01	611561	613561
0.35	611826	—	0.78	611919	—	1.02	611562	613562
0.36	611880	—	0.79	611920	—	1.03	611563	613563
0.37	611881	—	0.8	611921	—	1.04	611564	613564
0.38	611882	—	0.81	611922	—	1.05	611565	613565
0.39	611883	—	0.82	611923	—	1.06	611566	613566
0.4	611827	—	0.83	611924	—	1.07	611567	613567
0.41	611884	—	0.84	611925	—	1.08	611568	613568
0.42	611885	—	0.85	611926	—	1.09	611569	613569
0.43	611886	—	0.86	611927	—	1.1	611570	613570
0.44	611887	—	0.87	611928	—	1.11	611571	613571
0.45	611828	—	0.88	611929	—	1.12	611572	613572
0.46	611888	—	0.89	611930	—	1.13	611573	613573
0.47	611889	—	0.9	611931	—	1.14	611574	613574
0.48	611890	—	0.91	611932	—	1.15	611575	613575
0.49	611891	—	0.92	611933	—	1.16	611576	613576
0.5	611506	613506	0.93	611934	—	1.17	611577	613577
0.51	611892	—	0.94	611935	—	1.18	611578	613578
0.52	611893	—	0.95	611936	—	1.19	611579	613579

Length (mm)	Order No.		Length (mm)	Order No.		Length (mm)	Order No.	
	Steel	CERA		Steel	CERA		Steel	CERA
1.2	611580	613580	2.17	611717	—	13	611623	613623
1.21	611581	613581	2.18	611718	—	13.5	611653	613653
1.22	611582	613582	2.19	611719	—	14	611624	613624
1.23	611583	613583	2.2	611720	—	14.5	611654	613654
1.24	611584	613584	2.21	611721	—	15	611625	613625
1.25	611585	613585	2.22	611722	—	15.5	611655	613655
1.26	611586	613586	2.23	611723	—	16	611626	613626
1.27	611587	613587	2.24	611724	—	16.5	611656	613656
1.28	611588	613588	2.25	611725	—	17	611627	613627
1.29	611589	613589	2.26	611726	—	17.5	611657	613657
1.3	611590	613590	2.27	611727	—	17.6	611854	613854
1.31	611591	613591	2.28	611728	—	18	611628	613628
1.32	611592	613592	2.29	611729	—	18.5	611658	613658
1.33	611593	613593	2.3	611730	—	19	611629	613629
1.34	611594	613594	2.31	611731	—	19.5	611659	613659
1.35	611595	613595	2.32	611732	—	20	611672	613672
1.36	611596	613596	2.33	611733	—	20.2	611855	613855
1.37	611597	613597	2.34	611734	—	20.5	611660	613660
1.38	611598	613598	2.35	611735	—	21	611631	613631
1.39	611599	613599	2.36	611736	—	21.5	611661	613661
1.4	611600	613600	2.37	611737	—	22	611632	613632
1.41	611601	613601	2.38	611738	—	22.5	611662	613662
1.42	611602	613602	2.39	611739	—	22.8	611856	613856
1.43	611603	613603	2.4	611740	—	23	611633	613633
1.44	611604	613604	2.41	611741	—	23.5	611663	613663
1.45	611605	613605	2.42	611742	—	24	611634	613634
1.46	611606	613606	2.43	611743	—	24.5	611664	613664
1.47	611607	613607	2.44	611744	—	25	611635	613635
1.48	611608	613608	2.45	611745	—	25.25	611754	613754
1.49	611609	613609	2.46	611746	—	30	611673	613673
1.5	611641	613641	2.47	611747	—	35	611755	613755
1.6	611516	613516	2.48	611748	—	40	611674	613674
1.7	611517	613517	2.49	611749	—	41.3	611857	613857
1.8	611518	613518	2.5	611642	613642	45	611756	613756
1.9	611519	613519	2.6	611750	—	50	611675	613675
2	611612	613612	2.7	611751	—	60	611676	613676
2.0005	611690	—	2.8	611752	—	70	611677	613677
2.001	611691	—	2.9	611753	—	75	611801	613801
2.002	611692	—	3	611613	613613	80	611678	613678
2.003	611693	—	3.5	611643	613643	90	611679	613679
2.004	611694	—	4	611614	613614	100	611681	613681
2.005	611695	—	4.5	611644	613644	125	611802	613802
2.006	611696	—	5	611615	613615	131.4	611858	613858
2.007	611697	—	5.1	611850	613850	150	611803	613803
2.008	611698	—	5.5	611645	613645	175	611804	613804
2.009	611699	—	6	611616	613616	200	611682	613682
2.01	611701	—	6.5	611646	613646	250	611805	613805
2.02	611702	—	7	611617	613617	300	611683	613683
2.03	611703	—	7.5	611647	613647	400	611684	613684
2.04	611704	—	7.7	611851	613851	500	611685	613685
2.05	611705	—	8	611618	613618	600	611840	—
2.06	611706	—	8.5	611648	613648	700	611841	—
2.07	611707	—	9	611619	613619	750	611842	—
2.08	611708	—	9.5	611649	613649	800	611843	—
2.09	611709	—	10	611671	613671	900	611844	—
2.1	611710	—	10.3	611852	613852	1000	611845	—
2.11	611711	—	10.5	611650	613650			
2.12	611712	—	11	611621	613621			
2.13	611713	—	11.5	611651	613651			
2.14	611714	—	12	611622	613622			
2.15	611715	—	12.5	611652	613652			
2.16	611716	—	12.9	611853	613853			

Metric Wear Block	
Length (mm)	Order No.
	Tungsten carbide
1	612611
2	612612

## DIMENSIONS

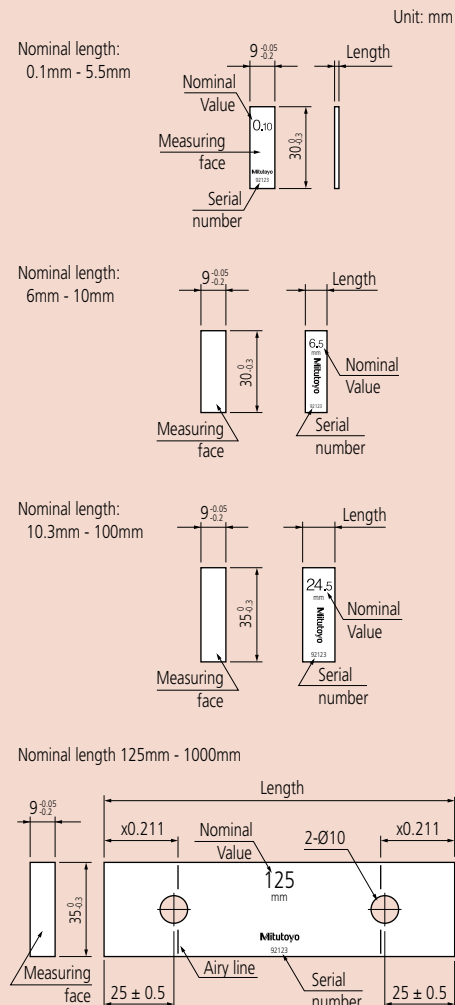

### Suffix Number for Selecting Standard and Certificate Provided

ASME	Grade	Steel, CERA
	K	-516**
	00	-521*
	0	-531*
	AS-1	-541*
	AS-2	-551*

\* provided with Inspection Certificate  
 \*\* provided with Calibration Certificate and Inspection Certificate

Example: 611310-521  
 .1" gage block in grade 00.

We make custom length gage blocks:  
 .004 - 20"



Inspection Certificate

### DIMENSIONS

Unit: Inch

Nominal length:  
 .004 - .25"

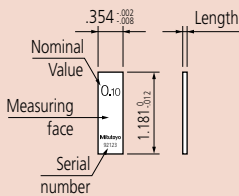

Nominal length:  
 .3 - 4"

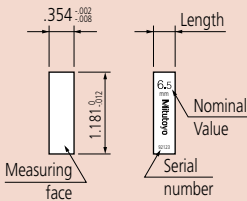

Nominal length:  
 .45 - 4"

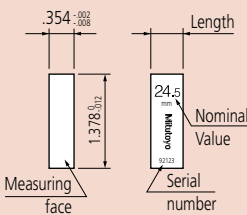

Nominal length 5 - 20"

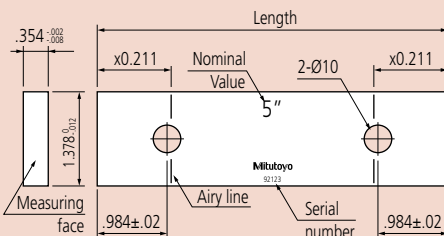

# Individual Inch Rectangular Gage Block

## SPECIFICATIONS

### Inch Block

Length (inch)	Order No.	
	Steel	CERA
.004	611304	—
.005	611305	—
.006	611306	—
.007	611307	—
.008	611308	—
.009	611309	—
.01	611310	—
.011	611311	—
.012	611312	—
.013	611313	—
.014	611314	—
.015	611315	—
.016	611316	—
.017	611317	—
.018	611318	—
.019	611319	—
.02	611320	—
.02005	611240	—
.0201	611231	—
.0202	611232	—
.0203	611233	—
.0204	611234	—
.0205	611235	—
.0206	611236	—
.0207	611237	—
.0208	611238	—
.0209	611239	—
.021	611321	—
.022	611322	—
.023	611323	—
.024	611324	—
.025	611325	—
.026	611326	—
.027	611327	—
.028	611328	—
.029	611329	—
.03	611330	—
.031	611331	—
.03125 (1/32)	611101	613103
.032	611332	—
.033	611333	—
.034	611334	—
.035	611335	—
.036	611336	—
.037	611337	—
.038	611338	—
.039	611339	—
.04	611340	—
.041	611341	—
.042	611342	—
.043	611343	—
.044	611344	—
.045	611345	—
.046	611346	—
.046875 (3/64)	611102	613104
.047	611347	—
.048	611348	—
.049	611349	—
.05	611105	613105

Length (inch)	Order No.	
	Steel	CERA
.06	611106	—
.0625	611303	613303
.07	611107	—
.078125 (5/64)	611103	613100
.08	611108	—
.09	611109	—
.09375 (3/32)	611104	613101
.1	611191	613191
.100025	611111	613110
.10005	611135	613135
.100075	611121	613111
.1001	611121	613121
.1002	611122	613122
.1003	611123	613123
.1004	611124	613124
.1005	611125	613125
.1006	611126	613126
.1007	611127	613127
.1008	611128	613128
.1009	611129	613129
.101	611141	613141
.102	611142	613142
.103	611143	613143
.104	611144	613144
.105	611145	613145
.106	611146	613146
.107	611147	613147
.108	611148	613148
.109	611149	613149
.109375 (7/64)	611110	613102
.11	611150	613150
.111	611151	613151
.112	611152	613152
.113	611153	613153
.114	611154	613154
.115	611155	613155
.116	611156	613156
.117	611157	613157
.118	611158	613158
.119	611159	613159
.12	611160	613160
.121	611161	613161
.122	611162	613162
.123	611163	613163
.124	611164	613164
.125	611165	613165
.126	611166	613166
.127	611167	613167
.128	611168	613168
.129	611169	613169
.13	611170	613170
.131	611171	613171
.132	611172	613172
.133	611173	613173
.134	611174	613174
.135	611175	613175
.136	611176	613176
.137	611177	613177
.138	611178	613178

Length (inch)	Order No.	
	Steel	CERA
.139	611179	613179
.14	611180	613180
.141	611181	613181
.142	611182	613182
.143	611183	613183
.144	611184	613184
.145	611185	613185
.146	611186	613186
.147	611187	613187
.148	611188	613188
.149	611189	613189
.15	611115	613115
.16	611116	613116
.17	611117	613117
.18	611118	613118
.19	611119	613119
.2	611192	613192
.21	611221	613221
.25	611212	613212
.3	611193	613193
.315	611209	613209
.35	611213	613213
.375 (3/8)	611113	613112
.4	611194	613194
.420	611210	613210
.45	611214	613214
.5	611195	613195
.55	611215	613215
.6	611196	613196
.605	611211	613211
.65	611216	613216
.7	611197	613197
.710	611220	613220
.75	611217	613217
.8	611198	613198
.815	611226	613226
.85	611218	613218
.9	611199	613199
.920	611227	613227
.95	611219	613219
1	611201	613201
2	611202	613202
3	611203	613203
4	611204	613204
5	611205	613205
6	611206	613206
7	611207	613207
8	611208	613208
10	611222	613222
12	611223	613223
16	611224	613224
20	611225	613225

### Inch Wear Block

Length (inch)	Order No.
	Tungsten carbide
.05	612105
.1	612191

# Rectangular Gage Block with CTE

## Gage Blocks with Thermal Expansion Coefficient Data

### FEATURES

- Mitutoyo offers top-level gage blocks (steel and ceramic) which are superior to K class blocks.
- Comes with a highly accurate thermal expansion coefficient measured with a high-accuracy double-faced interferometer (DFI).
- The high-accuracy gage block interferometer (GBI) guarantees high dimensional accuracy.
- Mitutoyo offers rectangular gage blocks, having nominal values from 100 to 500mm  
Grade: K class in ASME  
Uncertainty of thermal expansion coefficient:  $0.035 \times 10^{-6}/K$  ( $k = 2$ )  
Uncertainty of dimension measurement: 30nm ( $k = 2$ ), for 100mm block

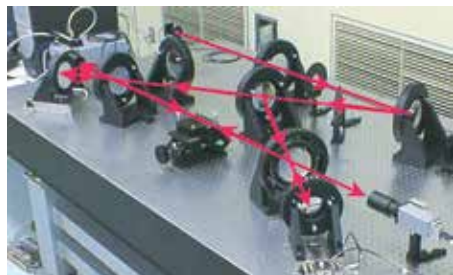

Double-faced interferometer (DFI)

### SPECIFICATIONS

Metric Block with CTE		
Length (mm)	Order No. Steel	Order No. CERA
100	611681-51B	613681-51B
125	611802-51B	613802-51B
150	611803-51B	613803-51B
175	611804-51B	613804-51B
200	611682-51B	613682-51B
250	611805-51B	613805-51B
300	611683-51B	613683-51B
400	611684-51B	613684-51B
500	611685-51B	613685-51B

Inch Block with CTE		
Length (inch)	Order No. Steel	Order No. CERA
4	611204-51B	613204-51B
5	611205-51B	613205-51B
6	611206-51B	613206-51B
7	611207-51B	613207-51B
8	611208-51B	613208-51B
10	611222-51B	613222-51B
12	611223-51B	613223-51B
16	611224-51B	613224-51B
20	611225-51B	613225-51B

### Suffix Number for Selecting Standard and Certificate Provided

ASME	
Grade K	-51B

-51B: provided with JCSS Calibration Certificate and Inspection Certificate

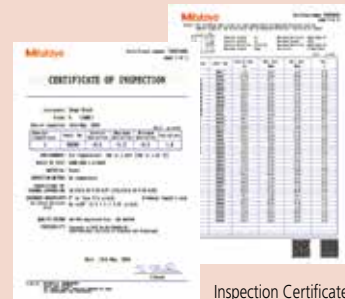

Inspection Certificate

### ZERO CERA Blocks

- Thermal expansion in the temperature range  $20 \pm 1^\circ C$  less than 1/500 that of steel ( $0 \pm 0.02 \times 10^{-6}/K(20^\circ C)$ )
- Almost no secular change both in dimension and coefficient of thermal expansion
- Complementary ultra-low thermal expansion and high specific rigidity (Young's Modulus/specific gravity)



### SPECIFICATIONS

Metric Blocks			
Order No.			Length (mm)
JIS/ISO/DIN	BS	ASME	
617673-016	617673-116	617673-516	30
617675-016	617675-116	617675-516	50
617681-016	617681-116	617681-516	100
617682-016	617682-116	617682-516	200
617683-016	617683-116	617683-516	300
617684-016	617684-116	617684-516	400
617685-016	617685-116	617685-516	500
617840-016	617840-116	617840-516	600
617841-016	617841-116	617841-516	700
617843-016	617843-116	617843-516	800
617844-016	617844-116	617844-516	900
617845-016	617845-116	617845-516	1000
516-771-60	516-771-61	516-771-66	Above set



# Rectangular Gage Block Accessories

## SERIES 516 – For Gage Blocks over 100mm

Specially designed for long gage blocks over 100mm, which have two holes on the body for coupling.



### SPECIFICATIONS

#### Accessories for gage blocks over 100mm

Order No. 516-605	Included in set
1 pc.	Holder A (619031)
1 pc.	Holder B (619032)
1 pc.	Holder C (619033)
1 pc.	Holder D (619034)
1 pc.	Holder E (619035)
3 pcs.	Adaptor (619036)
1 pc.	Holder base 35mm (619009)
2 pcs.	Half round jaw 12mm (619013)
1 pc.	Plain jaw (2 pc. set) (619018)
1 pc.	Scriber point (619019)

Note: These accessories can be used for inch rectangular gage blocks.

#### Holder A: 619031

Used for coupling two long gage blocks.

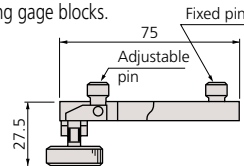

#### Holder B and C:

Used for coupling two long gage blocks together with other gage blocks up to 35mm (Holder B) or 140mm (Holder C). Also used for attaching jaws with two adaptors.

	Order No.	R (max.)	L
Holder B	619032	90mm	126mm
Holder C	619033	200mm	236mm

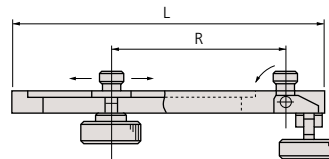

#### Holder D: 619034

Used for attaching to the holder base.

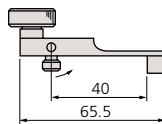

#### Holder E: 619035

Used for attaching to the holder base together with other gage blocks up to 125mm. Used for attaching jaws with one adaptor.

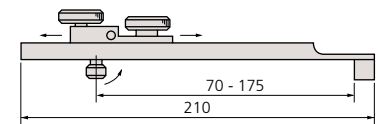

#### Holder base: 619009

Adaptor: 619036

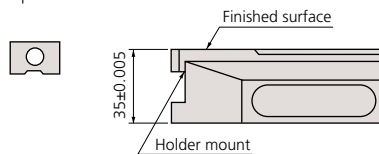

#### Half-round jaw: 619013

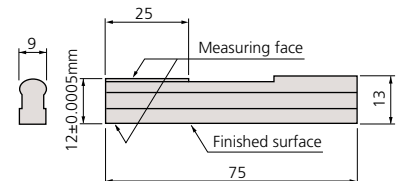

#### Plain jaw: 619018 (2 pc. set)

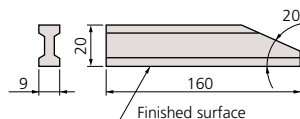

#### Scriber point: 619019

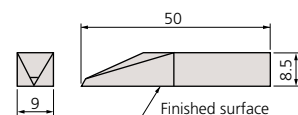

# Rectangular Gage Block Accessories

## SERIES 516

To expand the variety of rectangular gage block (steel and CERA) applications, Mitutoyo offers the gage block accessories set. By assembling the items in the set, you can easily and quickly build up a precision measuring instrument.



516-601



516-602

## SPECIFICATIONS

### Assortment of Accessories

Order No.	Accessories	Metric Set Order No.		Accessory (s) included in a set
		516-601	516-602	
619002	Holder 60mm		•	1 pc.
619003	Holder 100mm	•	•	1 pc.
619004	Holder 160mm	•	•	1 pc.
619005	Holder 250mm	•	•	1 pc.
619009	Holder Base 35mm	•	•	1 pc.
619010	Half round jaw 2mm	•	•	2 pcs.
619011	Half round jaw 5mm	•	•	2 pcs.
619012	Half round jaw 8mm	•	•	2 pcs.
619013	Half round jaw 12mm	•	•	2 pcs.
619014	Half round jaw 20mm	•	•	2 pcs.
619018	Plain jaw (2 pc. set) 160mm	•		1 pc.
619019	Scriber point	•	•	1 pc.
619020	Center point	•	•	1 pc.
619021	Tram point	•	•	2 pcs.
619022	Triangular straightness edge 100mm	•	•	1 pc.
619023	Triangular straight edge 160mm	•		1 pc.
	<b>Total Qty. in set</b>	22 pcs.	14 pcs.	



# Rectangular Gage Block Accessories

Holder:  
Used as a clamp if using plain jaws, scriber point, etc.

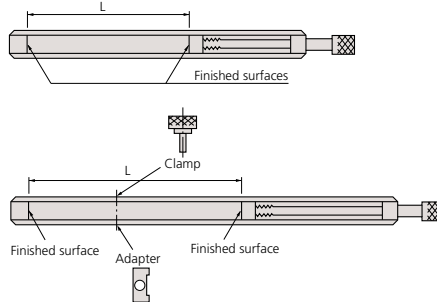

Order No.	L
619002	15 - 61mm
619003	4 - 106mm
619004	62 - 165mm
619005	153 - 256mm

Holder base 35mm: **619009**  
Measures a height on the surface plate and scribes a workpiece if used with the holder.

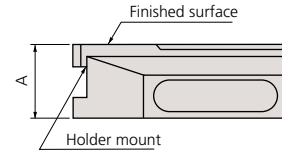

Order No.	A
619009	35±0.005mm

Scriber point: **619019**  
Scribes a workpiece if used with the holder and holder base.

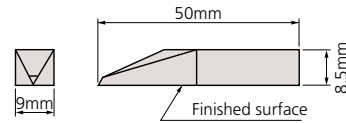

Center point: **619020**  
Scribes a workpiece if used with the holder and holder base.

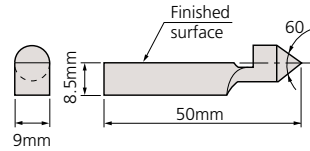

Tram point: **619021**  
Inspects the scale of the height gage, etc., if used with the holder and holder base.

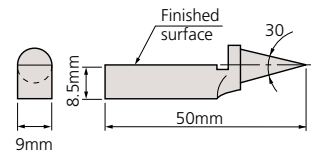

Plain jaw: **619018**  
Measures an outside or inside diameter if used with a pair of jaws and the holder.

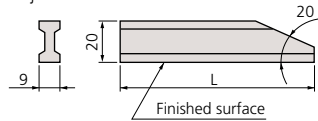

Order No.	L
619018*	160mm

\* 2 pc. set

Triangular straight edge: Measures parallelism.

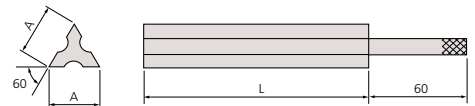

Order No.	L
619022	100mm
619023	160mm

Half-round jaw:  
Measures an outside or inside diameter if used with a pair of jaws and the holder.

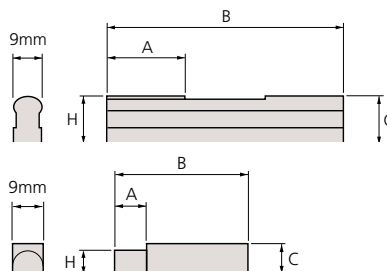

Order No.	H	A	B	C
619010	2±0.0005mm	6mm	40mm	8mm
619011	5±0.0005mm	6mm	50mm	8mm
619012	8±0.0005mm	12mm	60mm	8mm
619013	12±0.0005mm	25mm	75mm	13mm
619014	20±0.0005mm	25mm	125mm	20.5mm

# Metric Square Gage Block Set

## SERIES 516 — Metric Block Set, Long Block Set, Wear Block Set

A square gage block can retain stable orientation both longitudinally and laterally. A wide range of application measurements can be made, including cutting tool positioning, angle measurement with a sine bar, taper measurement with a roller, and inspection of depth micrometers.



Steel 32-block set



Steel 76-block set



Steel 103-block set



Steel 112-block set

## SPECIFICATIONS

### Metric Block Set

Blocks per set	Order No.		Grade	Blocks included in set		
	Steel	CERA		Size	Step	Qty.
<b>112</b>	516-437-26	—	00	1.0005	—	1
	516-438-26	—	0	1.001 - 1.009	0.001	9
	516-439-26	—	AS-1	1.01 - 1.49	0.01	49
	516-440-26	—	AS-2	0.5 - 24.5	0.5	49
	—	—	—	25 - 100	25	4
<b>103</b>	516-441-26	—	00	1.005	—	1
	516-442-26	—	0	1.01 - 1.49	0.01	49
	516-443-26	—	AS-1	0.5 - 24.5	0.5	49
	516-444-26	—	AS-2	25 - 100	25	4
	—	—	—	—	—	—
<b>76</b>	516-449-26	—	00	1.005	—	1
	516-450-26	—	0	1.01 - 1.49	0.01	49
	516-451-26	—	AS-1	0.5 - 9.5	0.5	19
	516-452-26	—	AS-2	10 - 40	10	4
	—	—	—	50 - 100	25	3
<b>47</b>	516-457-26	—	00	1.005	—	1
	516-458-26	—	0	1.01 - 1.09	0.01	9
	516-459-26	—	AS-1	1.1 - 1.9	0.1	9
	516-460-26	—	AS-2	1 - 24	1	24
	—	—	—	25 - 100	25	4
<b>32</b>	516-465-26	—	00	1.005	—	1
	516-466-26	—	0	1.01 - 1.09	0.01	9
	516-467-26	—	AS-1	1.1 - 1.9	0.1	9
	516-468-26	—	AS-2	1 - 9	1	9
	—	—	—	10 - 30	10	3
	—	—	—	60	—	1

### Metric Long Block Set

Blocks per set	Order No.		Grade	Blocks included in set		
	Steel	CERA		Size	Step	Qty.
<b>8</b>	516-751-26	—	00	125, 150, 175	25	3
	516-752-26	—	0	200, 250	50	2
	516-753-26	—	AS-1	300, 400, 500	100	3
	516-754-26	—	AS-2	—	—	—
	—	—	—	—	—	—

### Metric Wear Block Set

Blocks per set	Order No.		Grade	Blocks included in set		
	Carbide	CERA		Size	Step	Qty.
<b>2</b>	516-820-26	—	0	1	—	2
	516-821-26	—	AS-1	—	—	—

Provided with Inspection Certificate





Provided with Inspection Certificate

# Inch Square Gage Block Set

**SERIES 516 — Inch Block Set, Long Block Set, Wear Block Set**

## SPECIFICATIONS

### Inch Block Set

Blocks per set	Order No.		Grade	Blocks included in set		
	Steel	CERA		Size	Step	Qty.
<b>81</b>	516-401-26	516-201-26	00	.1001 - .1009	.0001	9
	516-402-26	516-202-26	0	.101 - .149	.001	49
	516-403-26	516-203-26	AS-1	.05 - .95	.05	19
	516-404-26	516-204-26	AS-2	1 - 4	1	4
<b>36</b>	516-421-26	516-221-26	00	.05"		1
	516-422-26	516-222-26	0	.1001 - .1009	.0001	10
	516-423-26	516-223-26	AS-1	.101 - .109	.001	9
	516-424-26	516-224-26	AS-2	.11 - .19	.01	9
				.1 - .5	.1	5
1, 2, 4	1	3				
<b>28</b>	516-417-26	—	00	.02005"		1
	516-418-26	—	0	.0201 - .0209"	.0001	9
	516-419-26	—	AS-1	.021 - .029"	.001	9
	516-420-26	—	AS-2	.021 - .029"	.01	9
				.10 - .090"		

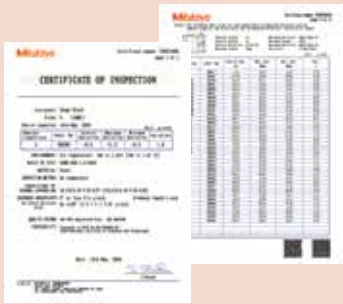

Steel 47-block set

### Inch Long Block Set

Blocks per set	Order No.		Grade	Blocks included in set		
	Steel	CERA		Size	Step	Qty.
<b>8</b>	516-762-26	—	0	5 - 7	1	3
	516-763-26	—	AS-1	8, 10, 12	2	3
				16, 20	4	2



Steel 8-block set

### Inch Wear Block Set

Blocks per set	Order No.		Grade	Blocks included in set		
	Carbide	CERA		Size	Step	Qty.
<b>2</b>	516-824-26	516-846-26	0	.05	—	2
	516-825-26	516-847-26	AS-1			
<b>2</b>	516-826-26	516-844-26	0	.1	—	2
	516-827-26	516-845-26	AS-1			



Carbide 2-block set

### 92 pcs. Gage Blocks with accessories set in wooden box

Blocks in set	Order No.	Grade	Blocks included in set			Individual No.	Description	Qty.
			Size	Step	Qty.			
<b>92</b>	516-405-26	0	.0625	.0001	1	619052	Plain Jaw .500"	2
			.078125		1	619051	Half round jaw .250"	2
			.09375		1	619055	Holder base .500"	1
			.100025		1	619057	Flat head screw 1 1/4"	2
			.10005		1	619058	Flat head screw 5/8"	2
			.100075		1	619056	Stud	2
			.109375		1	619066	Knurled head screw	2
			.1001 - .1009		9	619059	Slotted head nut	2
			.101 - .149		49	619062	Tie rod 3"	1
			.05 - .95		4	619063	Tie rod 2 1/4"	1
			.16 - .19		19	619064	Tie rod 1 1/2"	1
			1 4		4	619065	3/4"	1

# Individual Metric Square Gage Block



## SPECIFICATIONS

### Metric Block

Length (mm)	Order No.	
	Steel	CERA
0.5	614506	—
1	614611	—
1.0005	614520	—
1.001	614521	—
1.002	614522	—
1.003	614523	—
1.004	614524	—
1.005	614525	—
1.006	614526	—
1.007	614527	—
1.008	614528	—
1.009	614529	—
1.01	614561	—
1.02	614562	—
1.03	614563	—
1.04	614564	—
1.05	614565	—
1.06	614566	—
1.07	614567	—
1.08	614568	—
1.09	614569	—
1.1	614570	—
1.11	614571	—
1.12	614572	—
1.13	614573	—
1.14	614574	—
1.15	614575	—
1.16	614576	—
1.17	614577	—
1.18	614578	—
1.19	614579	—
1.2	614580	—
1.21	614581	—
1.22	614582	—
1.23	614583	—
1.24	614584	—
1.25	614585	—
1.26	614586	—
1.27	614587	—
1.28	614588	—
1.29	614589	—
1.3	614590	—
1.31	614591	—
1.32	614592	—

Length (mm)	Order No.	
	Steel	CERA
1.33	614593	—
1.34	614594	—
1.35	614595	—
1.36	614596	—
1.37	614597	—
1.38	614598	—
1.39	614599	—
1.4	614600	—
1.41	614601	—
1.42	614602	—
1.43	614603	—
1.44	614604	—
1.45	614605	—
1.46	614606	—
1.47	614607	—
1.48	614608	—
1.49	614609	—
1.5	614641	—
1.6	614516	—
1.7	614517	—
1.8	614518	—
1.9	614519	—
2	614612	—
2.5	614642	—
3	614613	—
3.5	614643	—
4	614614	—
4.5	614644	—
5	614615	—
5.5	614645	—
6	614616	—
6.5	614646	—
7	614617	—
7.5	614647	—
8	614618	—
8.5	614648	—
9	614619	—
9.5	614649	—
10	614671	—
10.5	614650	—
11	614621	—
11.5	614651	—
12	614622	—
12.5	614652	—

Length (mm)	Order No.	
	Steel	CERA
13	614623	—
13.5	614653	—
14	614624	—
14.5	614654	—
15	614625	—
15.5	614655	—
16	614626	—
16.5	614656	—
17	614627	—
17.5	614657	—
18	614628	—
18.5	614658	—
19	614629	—
19.5	614659	—
20	614672	—
20.5	614660	—
21	614631	—
21.5	614661	—
22	614632	—
22.5	614662	—
23	614633	—
23.5	614663	—
24	614634	—
24.5	614664	—
25	614635	—
30	614673	—
40	614674	—
50	614675	—
60	614676	—
75	614801	—
100	614681	—
125	614802	—
150	614803	—
175	614804	—
200	614682	—
250	614805	—
300	614683	—
400	614684	—
500	614685	—

### Metric Wear Block

Length (mm)	Order No. Tungsten carbide
1	615611
2	615612

Suffix Number for Selecting Standard and Certificate Provided

### ASME

Grade	Steel
K	—
00	-521*
0	-531*
AS-1	-541*
AS-2	-551*

\* provided with Inspection Certificate

Example: 614611-521  
1mm gage block in grade 00.

We make custom length gage blocks:  
0.5 - 500mm.



Inspection Certificate

# Individual Inch Square Gage Block

## Suffix Number for Selecting Standard and Certificate Provided

ASME	
Grade	Steel, CERA
K	—
00	-521*
0	-531*
AS-1	-541*
AS-2	-551*

\* provided with Inspection Certificate

Example: 614310-521  
.01" gage block in grade 00.

We make custom length gage blocks:  
.01 - 20"



Inspection Certificate

## DIMENSIONS

Nominal length: 0.5mm - 4.5mm  
(.010" - .19")

Unit: mm

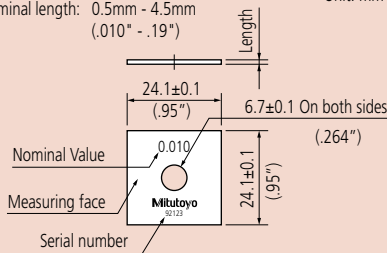

Nominal length: 5mm - 14.5mm  
(.02" - .450")

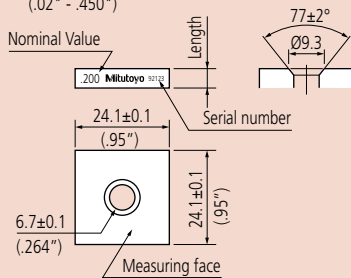

Nominal length: 15mm - 500mm  
(.500" - 20")

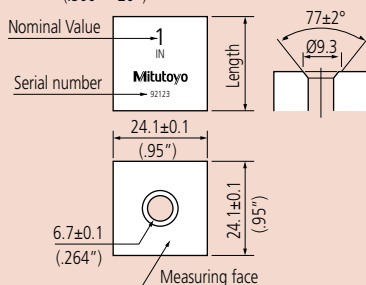

## SPECIFICATIONS

### Inch Block

Length (inch)	Order No.		Length (inch)	Order No.		Length (inch)	Order No.	
	Steel	CERA		Steel	CERA		Steel	CERA
.01	614310	—	.106	614146	616146	.25	614212	616212
.02005	614240	—	.107	614147	616147	.3	614193	616193
.0201	614231	—	.108	614148	616148	.35	614213	616213
.0202	614232	—	.109	614149	616149	.375 (3/8)	614309	—
.0203	614233	—	.109375 (7/64)	614306	—	.4	614194	616194
.0204	614234	—	.11	614150	616150	.45	614214	616214
.0205	614235	—	.111	614151	616151	.5	614195	616195
.0206	614236	—	.112	614152	616152	.55	614215	616215
.0207	614237	—	.113	614153	616153	.6	614196	616196
.0208	614238	—	.114	614154	616154	.65	614216	616216
.0209	614239	—	.115	614155	616155	.7	614197	616197
.02	614320	—	.116	614156	616156	.75	614217	616217
.021	614321	—	.117	614157	616157	.8	614198	616198
.022	614322	—	.118	614158	616158	.85	614218	616218
.023	614323	—	.119	614159	616159	.9	614199	616199
.024	614324	—	.12	614160	616160	.95	614219	616219
.025	614325	—	.121	614161	616161	1	614201	616201
.026	614326	—	.122	614162	616162	2	614202	616202
.027	614327	—	.123	614163	616163	3	614203	616203
.028	614328	—	.124	614164	616164	4	614204	616204
.029	614329	—	.125	614165	616165	5	614205	—
.03	614330	—	.126	614166	616166	6	614206	—
.03125 (1/32)	614301	—	.127	614167	616167	7	614207	—
.04	614340	—	.128	614168	616168	8	614208	—
.046875 (3/64)	614302	—	.129	614169	616169	10	614222	—
.05	614105	616105	.13	614170	616170	12	614223	—
.06	614106	—	.131	614171	616171	16	614224	—
.0625	614303	616303	.132	614172	616172	20	614225	—
.07	614107	—	.133	614173	616173			
.078125 (5/64)	614304	—	.134	614174	616174			
.08	614108	—	.135	614175	616175			
.09	614109	—	.136	614176	616176			
.09375 (3/32)	614305	—	.137	614177	616177			
.1	614191	616191	.138	614178	616178			
.100025	614307	—	.139	614179	616179			
.10005	614135	616135	.14	614180	616180			
.100075	614308	—	.141	614181	616181			
.1001	614121	616121	.142	614182	616182			
.1002	614122	616122	.143	614183	616183			
.1003	614123	616123	.144	614184	616184			
.1004	614124	616124	.145	614185	616185			
.1005	614125	616125	.146	614186	616186			
.1006	614126	616126	.147	614187	616187			
.1007	614127	616127	.148	614188	616188			
.1008	614128	616128	.149	614189	616189			
.1009	614129	616129	.15	614115	616115			
.101	614141	616141	.16	614116	616116			
.102	614142	616142	.17	614117	616117			
.103	614143	616143	.18	614118	616118			
.104	614144	616144	.19	614119	616119			
.105	614145	616145	.2	614192	616192			

### Inch Wear Block

Length (inch)	Order No. Tungsten carbide
.05	615105
.1	615191

# Square Gage Block Accessories

## SERIES 516

To expand the variety of square gage block applications, Mitutoyo offers the gage block accessories set. By assembling the items in the set, you can easily and quickly build up a precision measuring instrument.



516-611

### SPECIFICATIONS

Metric	
Order No. 516-611	Included in set
2 pcs.	Half round jaw 2mm (619070)
2 pcs.	Half round jaw 5mm (619071)
2 pcs.	Plain jaw (619072)
1 pc.	Center point (619073)
1 pc.	Scriber point (619054)
1 pc.	Block base (619074)
2 pcs.	Flat head screw 1-1/4" (619057)
2 pcs.	Flat head screw 5/8" (619058)
2 pcs.	Slotted head nut (619059)
2 pcs.	Adjustable tie rod 6" (619060)
2 pcs.	Adjustable tie rod 4-1/2" (619061)
1 pc.	Tie rod 3" (619062)
1 pc.	Tie rod 2-1/4" (619063)
1 pc.	Tie rod 1-1/2" (619064)
1 pc.	Tie rod 3/4" (619065)
2 pcs.	Stud (619056)
2 pcs.	Knurled head screw (619066)

Inch	
Order No. 516-612	Included in set
2 pcs.	Half round jaw .125" (619050)
2 pcs.	Half round jaw .25" (619051)
2 pcs.	Plain jaw (619052)
1 pc.	Center point (619053)
1 pc.	Scriber point (619054)
1 pc.	Block base (619055)
2 pcs.	Flat head screw 1-1/4" (619057)
2 pcs.	Flat head screw 5/8" (619058)
2 pcs.	Slotted head nut (619059)
2 pcs.	Adjustable tie rod 6" (619060)
2 pcs.	Adjustable tie rod 4-1/2" (619061)
1 pc.	Tie rod 3" (619062)
1 pc.	Tie rod 2-1/4" (619063)
1 pc.	Tie rod 1-1/2" (619064)
1 pc.	Tie rod 3/4" (619065)
2 pcs.	Stud (619056)
2 pcs.	Knurled head screw (619066)

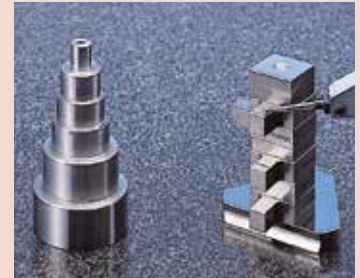

Half round jaw:  
Used to measure an inside or outside diameter.

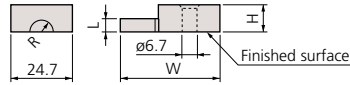

Order No.	R	L	W	H
619070	1.95mm	2mm	33.6mm	5.3mm
619071	4.95mm	5mm	39.9mm	10.3mm
619050	.123"	.125"	33.6mm	5.3mm
619051	.248"	.25"	39.9mm	10.3mm

Plain jaw: 619072 (10mm), 619052 (.5")  
Used to measure an inside or outside diameter.

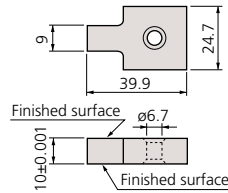

Center point: 619073 (2mm), 619053 (.1")  
Used to scribe a workpiece.

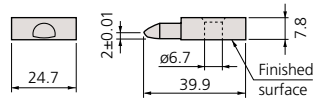

Scriber point: 619054  
Used to scribe a workpiece.

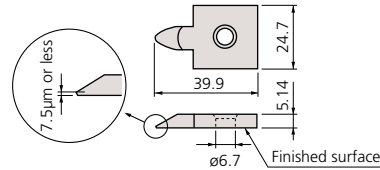

Base: 619074 (10mm), 619055 (.5")  
Used as clamps by inserting them into the center hole of a square gage block.

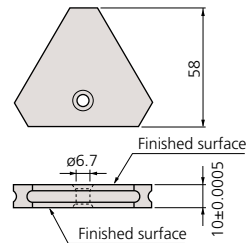

Stud: 619056

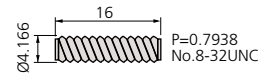

Flat head screw

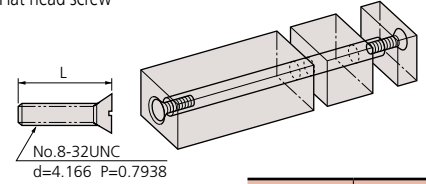

Order No.	L
619057	31.6mm
619058	15.8mm

Slotted head nut: 619059

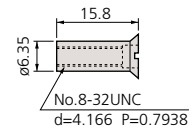

Knurled head screw: 619066

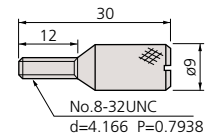

Tie rod

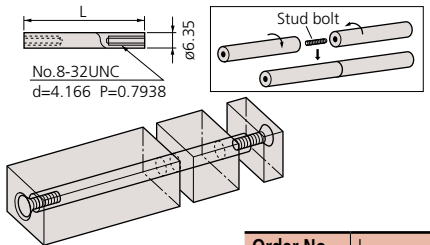

Order No.	L
619065	19mm
619064	38mm
619063	57mm
619062	76mm

Adjustable tie rod

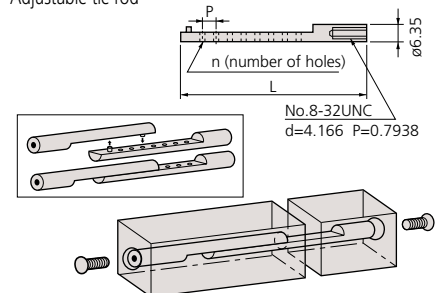

Order No.	L	P	n
619060	124.5mm	6.35mm	14
619061	86.5mm	6.35mm	8

# Ceraston

## Accessory for Gage Blocks

### FEATURES

- Alumina-ceramic grinding stone for removing burrs from hard materials such as ceramics that ordinary grinding stones cannot handle.
- Can be used both for steel gage blocks and CERA Blocks.



### SPECIFICATIONS

Order No.	Dimensions (W x D x H)	Mass
601645	100 x 25 x 12mm	110g
601644	150 x 50 x 20mm	530g

# Maintenance Kit for Gage Blocks

## SERIES 516

### FEATURES

- Includes all necessary maintenance tools for daily care and storage of gage blocks.
- Supplied in a fitted wooden case for portable use.



### SPECIFICATIONS

Order No.	Assortment of tools and accessories
516-650E	Ceraston (601645): Used for removing burrs on the measuring surface.
	Optical flat (158-117): Used for checking whether burrs exist.
	Tweezers (600004): Used for handling thin gage blocks.
	Blower brush (600005): Used for blowing out dust on the measuring surface.
	Cleaning paper (600006): Used for wiping off rust preventive oil and contamination.
	Artificial leather mat (600007): Used as a gage block mat.
	Reagent bottle (600008): Bottle of wiping solution (100mL)
	Gloves



### Removing burrs

- (1) Wipe any dust and oil films from the gage block and the Ceraston (or Arkansas stone) using a solvent.
- (2) Place the gage block on the Ceraston so that the measuring face that has burrs is on the abrasive surface of the stone. While applying light pressure, move the gage block to and fro about ten times (Fig. 1). Use a block rubber for thin gage blocks to apply even pressure (Fig. 2).
- (3) Check the measuring face for burrs with an optical flat. If the burrs have not been removed, repeat step (2). If burrs are too large, they may not be removed with a grinding stone. If so, discard the gage block.

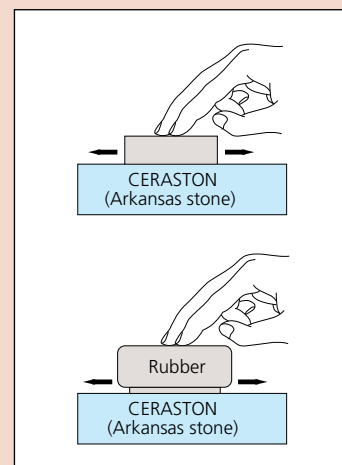

Note: The abrasive surface of a Ceraston must be made flat by lapping it from time to time. After lapping the Ceraston, the lapping powder must be completely removed from the surface to prevent the surface of the gage block from being scratched. Mitutoyo does not carry the Arkansas stone.



# Step Master

**SERIES 516**

## FEATURES

Step master is a master gage used for the z-axis (vertical direction) calibration of optical instruments.

- Each adjacent step is measured down to 0.01 $\mu$ m by using an interferometer within  $\pm 0.20\mu$ m allowance.
- Steel and ceramic types are available.

## Dimension

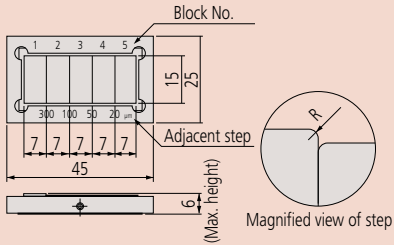

**516-498**  
Ceramic type



**516-199**  
Steel type



## SPECIFICATIONS

### Metric

Order No.	Step value between adjacent blocks				Remarks
	No. 1 - No. 2	No. 2 - No. 3	No. 3 - No. 4	No. 4 - No. 5	
<b>516-198</b>	10 $\mu$ m	5 $\mu$ m	2 $\mu$ m	1 $\mu$ m	Steel type
<b>516-199</b>	300 $\mu$ m	100 $\mu$ m	50 $\mu$ m	20 $\mu$ m	Steel type
<b>516-498</b>	10 $\mu$ m	5 $\mu$ m	2 $\mu$ m	1 $\mu$ m	Ceramic type
<b>516-499</b>	300 $\mu$ m	100 $\mu$ m	50 $\mu$ m	20 $\mu$ m	Ceramic type

# Made-to-order Block & Reference

## Available Dimension

Nominal size: .004 to 20" / 0.1 to 1000mm (steel)  
.1 to 20" / 0.5 to 500mm (ceramic)

Nominal pitch: 0.0005mm (up to 100mm)  
0.001mm (over 100mm)

Minimum section dimension:  
Approx. .24 x .24" / 6 x 6mm

Maximum section dimension:  
Approx. 5.5 x 5.5" / 140 x 140mm (steel)  
Approx. 6.3" Dia. /  $\phi$ 160mm (steel, cylindrical)  
Approx. 3.94 x 1.97" / 100 x 50mm (ceramic)  
Approx. .24" Dia. /  $\phi$ 60mm (ceramic, cylindrical)

Accuracy: Gage Block Grade level

Special materials of low expansion glass and low expansion ceramic are available.

## FEATURES

- Mitutoyo can provide gage blocks and reference gages to your size and design.

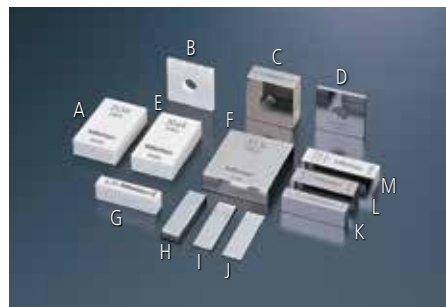

- A: Ceramic rectangular gage block (21.94mm)
- B: Ceramic square gage block (2.1005mm)
- C: Steel square gage block (10.72mm)
- D: Steel square gage block (2.2065mm)
- E: Ceramic rectangular gage block (20.64mm)
- F: Steel rectangular gage block (31.5mm)
- G: Ceramic rectangular gage block (6.34mm)
- H: Steel rectangular gage block (3.603mm)
- I: Steel rectangular gage block (1.1505mm)
- J: Steel rectangular gage block (0.555mm)
- K: Steel rectangular gage block (6.156mm)
- L: Steel rectangular gage block (9.694mm)
- M: Steel rectangular gage block (10.02mm)

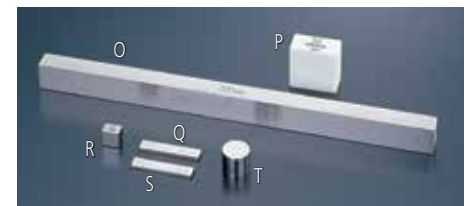

- O: Steel long rectangular block (15 x 10 x 200mm)
- P: Ceramic square block (24.1 x 24.1 x 12.3mm)
- Q: Steel thin rectangular block (30 x 6 x 1.9mm)
- R: Steel square block (9 x 9 x 6mm)
- S: Steel thin rectangular block (30 x 6 x 2.1mm)
- T: Steel cylindrical block ( $\phi$ 13.08 x 12mm)



- U: Cylindrical reference block for depth micrometer ( $\phi$ 60 x 150mm)
- V: Ceramic reference plate (50 x 50 x 50mm, flatness 0.3 $\mu$ m)
- W: Ceramic stepped block (30 x 18 x 5mm, step: 0.15mm)

# Gage Block Comparator GBCD-250

**SERIES 565 — Manual Comparator with Dual Gage Heads**

## FEATURES

- Gage blocks between 0.1mm and 250mm easily can be compared with the standard gage block on the GBCD-250.
- The differential dual gaging heads assure the operator of a high-accuracy measurement with ease of use.

## SPECIFICATIONS

Inch/Metric	
Model No.	GBCD-250
Order No.	565-151A
Range	0.1mm - 250mm / .004 - 10"
Resolution	0.00001mm(0.01μm)/.000001in(.1μin)
Accuracy in narrow range (20°C)	±(0.03+0.3L/1000)μm* L = Gage block length (mm)
Measuring units	Laser Hologage (upper and lower)
Operating condition	Temperature: 20°C ±1°C Humidity: 30% RH to 60% RH
Data output	Via SPC output port
Dimensions (W x D x H)	Main unit: 455 x 318 x 691mm Display unit: 345 x 397 x 187mm
Mass	Main unit: Approx. 52kg Display unit: Approx. 9kg

\* 95% confidence interval (not including the calibration error of the standard gage block).



## Optional Accessories

- 962723: Gage head calibration kit  
 02ASD130: Square gage block holder kit  
 02ASF040: Heat protection shield  
 02ASQ953: GBPAK-M  
 Supporting OS: Windows XP, Vista, 7, or 10  
 937179T: Foot Switch  
 936937: Connecting cable

# Gage Block Comparator GBCD-100A

**SERIES 565 — Automatic-Type Comparator with Dual Gage Heads**

## SPECIFICATIONS

Model No.	GBCD-100A
Order No.	565-160A
Resolution	0.00001mm (0.01μm) / .000001"
Range	0.5mm - 100mm / .02 - 4"
Measuring unit	Differential (dual-head) type Mu-Checker
Accuracy in narrow range (20°C)	±(0.03+0.3L/1000)μm* L = Gage block length (mm)
Measuring force	Upper gage head: 1N (100gf) Lower gage head: 0.6N (60gf)
Air requirement	400kPa (4kgf/cm <sup>2</sup> )
Operating condition	Temperature: 20°C ±1°C Humidity: 58%RH ±15%RH
Dimensions (W x D x H)	Main unit: 710 x 366 x 783mm Electronic unit: 160 x 410 x 382mm
Mass	Main unit: 120kg Electronic unit: 14kg

\* 95% confidence interval (not including the calibration error of the standard gage block).



The GBCD-100A Automatic Gage Block Comparator is an easy-to-operate dual-head gage block inspecting system. It automatically compares workpieces with a standard gage block and determines accuracies such as central length, maximum length, minimum length and parallelism through the operation of an optional personal computer.

## Standard Accessories

GBPAK-A (software)

## Optional Accessories

516-146-E1: Gage block set for GBCD calibration





### Technical Data

Graduation: .00001" or 0.001mm  
 Counter Resolution: .001" or 0.01mm  
 Character Height: .16" / 4mm  
 Micrometer Head  
 Travel stroke: 1" or 20mm  
 Pitch: .025"/rev or 0.5mm/rev  
 Hysteresis: .00004" or 1µm  
 Provided with inspection certificate.

### Standard Accessories

Reference Block: 11mm for 515-322  
 Reference Block: .3" for 515-310, 515-311

### Optional Accessories

515-112: Auxiliary block kit for bore gage (mm)  
 515-119: Auxiliary block kit for bore gage (for 515-310)  
 515-121: Auxiliary block kit for bore gage (for 515-311)  
 ———: Riser block

### Reading

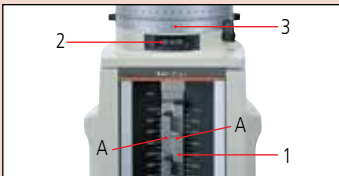

#### Height A

1. Scale	280	mm
2. Counter	5.67	mm
3. Thimble	0.000	mm
<hr/>		
	285.670	mm



# Height Master

## SERIES 515

### FEATURES

- Models with staggered arrangement of block stack have two measuring faces on the same level, one facing up and the other down (except for 515-310).
- Each height master is supplied with a gage block for zero-setting.
- Supplied in fitted wooden case.



515-322



515-310

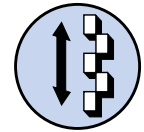

Staggered 20mm blocks (movable)

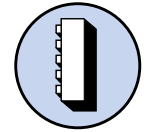

Vertical orientation

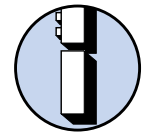

Riser block

### SPECIFICATIONS

#### Metric

Range (H)	Order No.	Block step	Graduation	Block Pitch Accuracy	Parallelism of Block	Micrometer Head Accuracy	Mass (kg)
5 < H ≤ 310mm	515-322	20mm (staggered)	0.001mm	±1.5µm	1µm	±1µm	23

#### Inch

Range (H)	Order No.	Block step	Graduation	Block Pitch Accuracy	Parallelism of Block	Micrometer Head Accuracy	Mass (kg)
.2" < H ≤ 12.2"	515-310	.5" (straight)	.00001"	±.00005"	.00004"	±.00005"	23
.2" < H ≤ 12.2"	515-311	1" (staggered)	.00001"	±.00005"	.00004"	±.00005"	23

# Digital Height Master

## SERIES 515

### FEATURES

- Standard model with a digital display, featuring all essential specifications required for versatile height standard.
- With SPC output.
- Each height master is supplied with a gage block for zero setting.



515-374

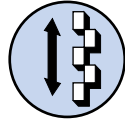

Staggered 20mm blocks (movable)

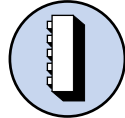

Vertical orientation

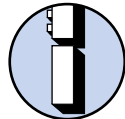

Riser block



### Technical Data

Resolution (LCD): .0001" or 0.001mm  
 Graduation: .0001" or 0.002mm  
 Character Height .21" / 5.4mm

### Micrometer Head

Travel Stroke: 1" or 20mm  
 Pitch: .025"/rev or 0.5mm/rev  
 Hysteresis: .0001" for all inch models  
 0.002mm for 300mm models  
 0.0025mm for 450 & 600mm models  
 Battery: SR44 (2 pcs.), **938882**  
 Battery life: Approx. 1.8 years under normal use

### Function

Zero-setting, Presetting, ABS/INC switching, Data hold, Data output, inch/mm conversion (on inch/metric models only)  
 Alarm: Low voltage, Counting value composition error

### Standard Accessories

Reference Block: 11mm for Metric Height Master **611621-031**  
 Reference Block: .6" for Inch Height Master **611196-531**  
 Provided with inspection certificate.

### Optional Accessories

- 515-111:** Auxiliary block kit for bore gage (mm)
- 515-120:** Auxiliary block kit for bore gage (inch)
- : Riser block (see page E-27.)
- 959149:** SPC cable (40" / 1m)
- 959150:** SPC cable (80" / 2m)
- 050019:** Fitted mahogany case for 12" / 300mm model
- 050059:** Fitted mahogany case for 18" / 450mm model  
24" / 600mm model

## SPECIFICATIONS

### Metric

Range (H)	Order No.	Block step	Resolution	Block Pitch Accuracy	Parallelism	Micrometer Head Accuracy	Mass (kg)
10 < H ≤ 310mm	<b>515-374</b>	20mm (staggered)	0.001mm	±1.5µm	2µm	±2µm	9.5
10 < H ≤ 460mm	<b>515-376</b>	20mm (staggered)	0.001mm	±2.5µm	2.5µm	±2µm	13.6
10 < H ≤ 610mm	<b>515-378</b>	20mm (staggered)	0.001mm	±3.5µm	2.5µm	±2.5µm	16.0

### Inch/Metric

Range (H)	Order No.	Block step	Resolution	Block Pitch Accuracy	Parallelism	Micrometer Head Accuracy	Mass (kg)
.5" < H ≤ 12"	<b>515-375</b>	1" (staggered)	.0001" / 0.001mm	±.0001"	.00005"	±.0001"	9.5
.5" < H ≤ 18"	<b>515-377</b>	1" (staggered)	.0001" / 0.001mm	±.0001"	.0001"	±.0001"	13.6
.5" < H ≤ 24"	<b>515-379</b>	1" (staggered)	.0001" / 0.001mm	±.0001"	.0001"	±.0001"	16.0

# Riser Blocks

## SERIES 515

### FEATURES

- These riser blocks are specially designed for standard/digimatic height masters.



515-113

515-114

515-115

### SPECIFICATIONS

Metric			
Height	Order No.	Accuracy of height	Mass (kg)
150mm	515-113	$\pm 0.6\mu\text{m}$	5.7
300mm	515-114	$\pm 1.0\mu\text{m}$	11.3
600mm	515-115	$\pm 2.0\mu\text{m}$	31

Inch			
Height	Order No.	Accuracy of height	Mass (kg)
6"	515-116	$\pm 20\mu\text{in}$	5.7
12"	515-117	$\pm 40\mu\text{in}$	11.3
24"	515-118	$\pm 80\mu\text{in}$	31

# Auxiliary Block Kit

## SERIES 515 — for Bore Gage

### FEATURES

- Used for efficient zero-setting of dial bore gages and tubular inside micrometers (18 - 150mm) on a Height Master.

Bore gage zero-setting



515-112

### SPECIFICATIONS

Metric	
Order No.	Applicable height master
515-110	Universal Height Master
515-111	Digimatic Height Master
515-112	Height Master

Inch	
Order No.	Applicable height master
515-119	Universal Height Master, Height Master (515-310)
515-120	Digimatic Height Master
515-121	Height Master (515-311)

# Universal Height Master

## SERIES 515 — Use in Vertical and Horizontal Orientation

### FEATURES

- The Universal Height Master is designed for both vertical and horizontal orientations, providing a wide range of applications, such as accuracy checking of machine tool table movements.
- Fitted wooden case supplied.



515-520

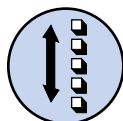

Single-row 10mm blocks (movable)



Vertical orientation

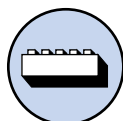

Horizontal orientation

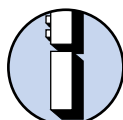

Riser block

### SPECIFICATIONS

#### Metric

Range (R)	Order No.	Block step	Graduation	Block Pitch Accuracy	Parallelism of Block	Micrometer Head Accuracy	Mass (kg)
$5 < R \leq 610\text{mm}$	<b>515-520</b>	10mm (straight)	0.001mm	$\pm 1.5\mu\text{m}$	$1.0\mu\text{m}$	$\pm 1.2\mu\text{m}$	42
$5 < R \leq 1010\text{mm}$	<b>515-523</b>	10mm (straight)	0.001mm	$\pm 3.5\mu\text{m}$	$2.5\mu\text{m}$	$\pm 1.5\mu\text{m}$	63.5

#### Inch

Range (R)	Order No.	Block step	Graduation	Block Pitch Accuracy	Parallelism of Block	Micrometer Head Accuracy	Mass (kg)
$.2" < R \leq 18.2"$	<b>515-512</b>	.5" (straight)	.00001"	$\pm .00005"$	.00006"	$\pm .00004"$	42
$.2" < R \leq 24.2"$	<b>515-510</b>	.5" (straight)	.00001"	$\pm .0001"$	.00006"	$\pm .00004"$	50
$.2" < R \leq 40.2"$	<b>515-513</b>	.5" (straight)	.00001"	$\pm .00015"$	.00008"	$\pm .00006"$	63.5



### Technical Data

Graduation: 0.001mm or .00001"  
 Counter Resolution: .001" or 0.01mm  
 Character Height: .16" / 4mm  
 Block arrangement: Straight arrangement

#### Micrometer Head

Travel stroke: 1" or 20mm  
 Pitch: .025"/rev or 0.5mm/rev  
 Hysteresis: .00004" / 1.2μm up to 24.2" / 610mm  
 .00006" / 1.5μm for 40.2" / 1010mm

Block pitch accuracy:  $\pm 1.5\mu\text{m}$  ( $0 < R \leq 310\text{mm}$ )  
 $\pm 2.5\mu\text{m}$  ( $310 < R \leq 610\text{mm}$ )  
 $\pm 3.5\mu\text{m}$  ( $610 < R \leq 1010\text{mm}$ )

Parallelism of blocks:  $1.0\mu\text{m}$  ( $0 < R \leq 310\text{mm}$ )  
 $2.5\mu\text{m}$  ( $310 < R \leq 1010\text{mm}$ )

Provided with inspection certificate.

### Optional Accessories

- 900574\***: Supporting base for vertical operation  
 Mass: 3kg  
 (\*supplied as a standard for **515-523** and **515-513**)
- 515-112**: Auxiliary block kit for bore gage (mm)  
**515-119**: Auxiliary block kit for bore gage (inch)



Using in horizontal orientation



Supporting base



# High-Accuracy Check Master HMC-H

## SERIES 515

### Technical Data

Measuring range (R): Refer to the list of specifications.  
 Block pitch accuracy:  $\pm 1.2\mu\text{m}$  ( $0 < R \leq 310\text{mm}$ )  
 $\pm 1.8\mu\text{m}$  ( $310 < R \leq 610\text{mm}$ )  
 $\pm 2.5\mu\text{m}$  ( $610 < R \leq 1010\text{mm}$ )  
 $\pm 4.0\mu\text{m}$  ( $1010 < R \leq 1510\text{mm}$ )  
 Parallelism of blocks:  $1.0\mu\text{m}$  ( $0 < R \leq 450\text{mm}$ )  
 $1.5\mu\text{m}$  ( $450 < R \leq 1010\text{mm}$ )  
 $2.0\mu\text{m}$  ( $1010 < R \leq 1510\text{mm}$ )  
 Provided with inspection certificate.

### FEATURES

- Designed to check the accuracy of table movements of machine tools and calibrate CMMs. Permanently wrung stack of gage blocks is housed in a rigid frame.
- Can be used in either vertical and horizontal orientation.
- Fitted wooden case supplied.

### Specifications for Ceramic Check Master:

- Each measuring block is made of zirconia-based ceramic that requires no anti-corrosion treatment for measuring faces.
- Free from deterioration and dimensional changes over time.

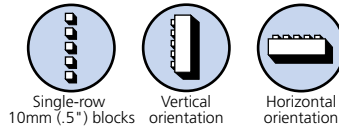

### SPECIFICATIONS

Range (R)	Order No.		Pitch		Accuracy of block pitch for the range shown below as measured from the bottom block				Length	Parallelism	Mass (kg)
	Steel	Ceramic	P	P	up to 300mm	300-600mm	600-1000mm	1000-1500mm			
300mm	515-740	515-760	20mm	10mm	$\pm 1.2\mu\text{m}$	—	—	—	331mm	$1\mu\text{m}$	3.6
450mm	515-741	515-761	20mm	10mm	$\pm 1.2\mu\text{m}$	$\pm 1.8\mu\text{m}$	—	—	482mm	$1\mu\text{m}$	5.4
600mm	515-742	515-762	20mm	10mm	$\pm 1.2\mu\text{m}$	$\pm 1.8\mu\text{m}$	—	—	631mm	$1.5\mu\text{m}$	7.2
1000mm	515-743	515-763	20mm	10mm	$\pm 1.2\mu\text{m}$	$\pm 1.8\mu\text{m}$	$\pm 2.5\mu\text{m}$	—	1037mm	$1.5\mu\text{m}$	12.0
1500mm	515-744	515-764	20mm	10mm	$\pm 1.2\mu\text{m}$	$\pm 1.8\mu\text{m}$	$\pm 2.5\mu\text{m}$	$\pm 4.0\mu\text{m}$	1546mm	$2\mu\text{m}$	18.0

### Inch

Range (R)	Order No.		Pitch		Accuracy of block pitch for the range shown below as measured from the bottom block				Length	Parallelism	Mass (kg)
	Steel	Ceramic	P	P	up to 12"	12-24"	24-40"	40-60"			
12"	515-730	515-750	1"	.5"	$\pm 50\mu\text{in}$	—	—	—	13.0"	$40\mu\text{in}$	3.4
18"	515-731	515-751	1"	.5"	$\pm 50\mu\text{in}$	$\pm 70\mu\text{in}$	—	—	19.0"	$40\mu\text{in}$	5.2
24"	515-732	515-752	1"	.5"	$\pm 50\mu\text{in}$	$\pm 70\mu\text{in}$	—	—	25.0"	$60\mu\text{in}$	6.9
40"	515-733	515-753	1"	.5"	$\pm 50\mu\text{in}$	$\pm 70\mu\text{in}$	$\pm 100\mu\text{in}$	—	41.0"	$60\mu\text{in}$	11.5
60"	515-734	515-754	1"	.5"	$\pm 50\mu\text{in}$	$\pm 70\mu\text{in}$	$\pm 100\mu\text{in}$	$\pm 158\mu\text{in}$	61.5"	$80\mu\text{in}$	17.3

### Optional Accessories

**601167:** Supporting base for vertical operation

Dimensions: 14.2" (W) x 8.7" (D) x 8.3" (H)  
 360mm (W) x 220mm (D) x 210mm (H)

Mass: 3kg



Supporting base

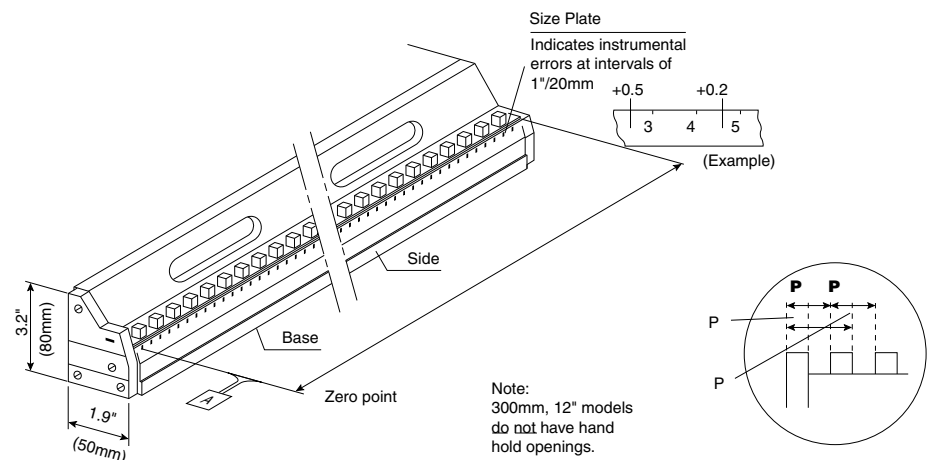

# CERA Straight Master SM-C

## SERIES 311 — Straightness Measuring Instrument

### FEATURES

CERA Straight master is a master gage used for the straightness inspection of each axis movement such as a CMM, machine tool, semiconductor-related equipment and form measuring machine.

- Made from Alumina-ceramic
- 50mm/2" pitch gradation scales
- Precision-lapped measuring surface
- Double-faced type is lapping the double face, which can be used for straightness in horizontal and vertical as a reference square.
- Lightweight
- Supplied with fitted wooden case.



### SPECIFICATIONS

Metric		Inch		High-accuracy model		
Nominal length	Order No.*	Nominal length	Order No.*	Straightness	Size (L x H x W)	Mass
400mm	311-302-33	16"	311-322-33	0.3μm	440 x 35 x 50mm	1.8kg
700mm	311-305-33	28"	311-325-33	0.5μm	740 x 35 x 50mm	3kg
1000mm	311-307-33	40"	311-327-33	1.0μm	1040 x 45 x 80mm	8kg
1300mm	311-309-33	52"	311-329-33	1.5μm	1340 x 45 x 80mm	10kg

Metric		Inch		Ultra-high accuracy model		
Nominal length	Order No.*	Nominal length	Order No.*	Straightness	Size (L x H x W)	Mass
400mm	311-332-33	16"	311-342-33	0.2μm	440 x 35 x 50mm	1.8kg
700mm	311-335-33	28"	311-345-33	0.4μm	740 x 35 x 50mm	3kg
1000mm	311-337-33	40"	311-347-33	0.5μm	1040 x 45 x 80mm	8kg
1300mm	311-339-33	52"	311-349-33	0.7μm	1340 x 45 x 80mm	10kg

Double-faced type



### SPECIFICATIONS

Metric		Inch		Double-faced model		
Nominal length	Order No.*	Nominal length	Order No.*	Straightness	Size (L x H x W)	Mass
400mm	311-352-33	16"	311-362-33	0.3μm	440 x 45 x 80mm	3.2kg
700mm	311-355-33	28"	311-365-33	0.5μm	740 x 45 x 80mm	5.5kg
1000mm	311-357-33	40"	311-367-33	1.0μm	1040 x 45 x 80mm	8kg
1300mm	311-359-33	52"	311-369-33	1.5μm	1340 x 45 x 80mm	10kg

### Technical Data

Provided with inspection certificate.

### Cross section

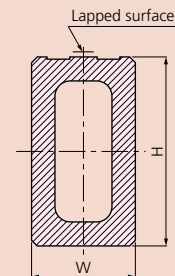

### Double-faced type

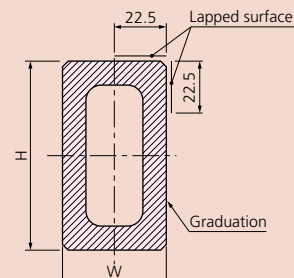

# Square Master

## SERIES 311 — Squareness / Straightness Measuring Instrument

### Technical Data

Squareness: Refer to the list of specifications  
 Straightness: Refer to the list of specifications  
 Dial test indicator provided  
 Range: 0.2mm  
 Graduation: 0.002mm  
 Accuracy: 3µm

### Optional Accessory

—: Riser blocks (see page E-27.)\*  
**900571:** Adjustable holder  
**900551:** Extension holder  
**900565:** Feeler\*\*

\*Not available for 450mm model.  
 \*\*Adapter (**902803**) is required for metric model.

### Adjustable holder

No.900571

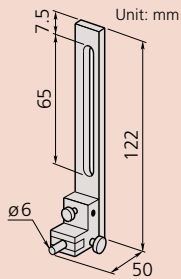

### Extension holder

No.900551

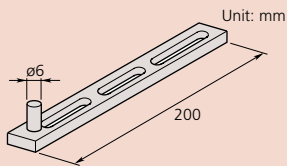

### Feeler

No.900565

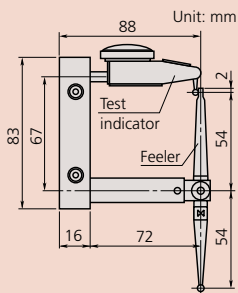

### FEATURES

- Squareness (perpendicularity) and straightness measurements can be performed accurately and efficiently by moving a lever.
- With a dial test indicator for reading displacements.
- Its own squareness is adjustable for high-accuracy measurement.



311-215



311-225



311-245

### SPECIFICATIONS

Metric				
Vertical travel	Order No.	Squareness	Straightness	Mass (kg)
150mm	<b>311-215</b>	3µm	2µm	13.7
250mm	<b>311-225</b>	6µm	2.5µm	16.2
450mm	<b>311-245</b>	9µm	3.5µm	24

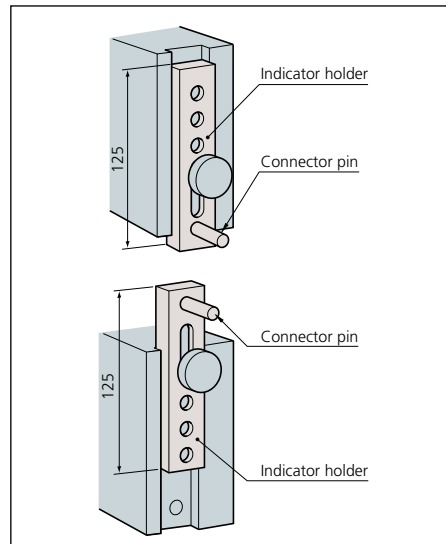

# Standard Scales

**SERIES 182 — Made of Low-Expansion Glass**

## FEATURES

- High-precision glass scales manufactured under Mitutoyo's leading-edge Linear Scale production technology.
- High accuracy is guaranteed to be used as a standard for calibrating graduated scales.

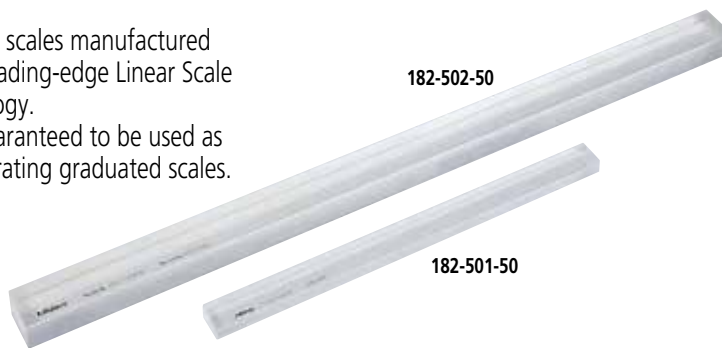

## DIMENSIONS

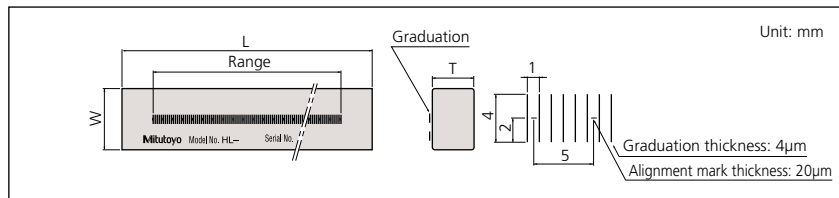

## Technical Data

Accuracy (at 20°C):  $(0.5+L/1000)\mu\text{m}$ ,  
 L = Measured length (mm)  
 Glass material: Low expansion glass  
 Thermal expansion coefficient:  $8 \times 10^{-6}/\text{K}$   
 Graduation: 1mm  
 Graduation thickness: 4µm  
 Mass: 0.75kg (250mm), 1.8kg (500mm)

## SPECIFICATIONS

### Metric

Range	Order No.	L	W	T
250mm	<b>182-501-50</b>	280mm	20mm	10mm
250mm	<b>182-501-60*</b>	280mm	20mm	10mm
500mm	<b>182-502-50</b>	530mm	30mm	20mm
500mm	<b>182-502-60*</b>	530mm	30mm	20mm

\*with English JCSS certificate.

# Working Standard Scales

**SERIES 182**

## FEATURES

- High-precision glass scales manufactured under Mitutoyo's leading-edge linear scale production technology.
- Ideal for checking magnification accuracy of profile projectors and microscopes, and the table feeding accuracy of measuring equipment.

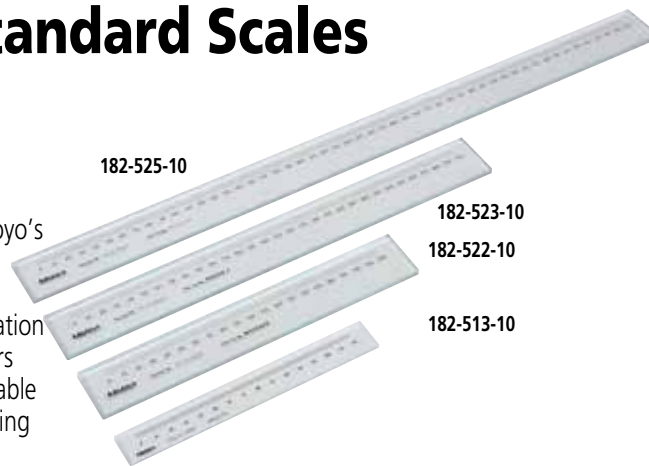

## DIMENSIONS

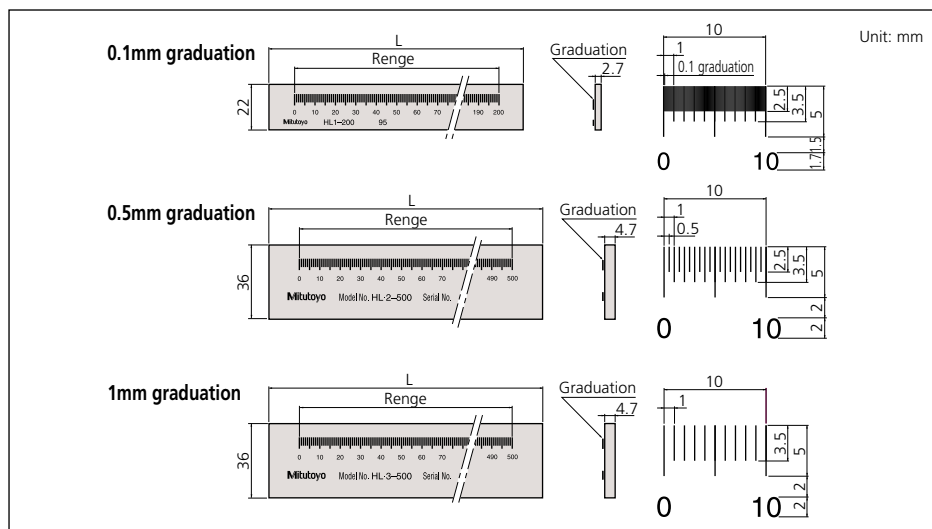

## Technical Data

Accuracy (at 20°C):  $(1.5+2L/1000)\mu\text{m}$ ,  
 L = Measured length (mm)  
 Glass material: Sodium glass  
 Thermal expansion coefficient:  $8.5 \times 10^{-6}/\text{K}$   
 Graduation: 0.1mm (thickness: 20µm)  
 0.5mm (thickness: 50µm)  
 1mm (thickness: 100µm)

## SPECIFICATIONS

### Metric

Range	Order No.	Graduation	L	Mass
50mm	<b>182-511-10</b>	0.1mm	75mm	0.23kg
100mm	<b>182-512-10</b>	0.1mm	125mm	0.24kg
150mm	<b>182-513-10</b>	0.1mm	175mm	0.35kg
200mm	<b>182-514-10</b>	0.1mm	225mm	0.36kg
100mm	<b>182-521-10</b>	0.5mm	130mm	0.27kg
200mm	<b>182-522-10</b>	0.5mm	230mm	0.32kg
300mm	<b>182-523-10</b>	0.5mm	330mm	0.57kg
400mm	<b>182-524-10</b>	0.5mm	430mm	0.71kg
500mm	<b>182-525-10</b>	0.5mm	530mm	0.86kg
250mm	<b>182-531-10</b>	1mm	280mm	0.55kg
500mm	<b>182-532-10</b>	1mm	530mm	0.86kg
750mm	<b>182-533-10</b>	1mm	780mm	1.22kg
1000mm	<b>182-534-10</b>	1mm	1030mm	1.54kg



# High-Precision Square

## SERIES 311

### FEATURES

The High-Precision Square gage is used for inspecting the travel straightness and axial perpendicularity of moving elements on equipment, such as machine tools, CMMs, form measuring machines and semiconductor-related equipment.

- Four precision-lapped reference surfaces.
- Better than 1 $\mu$ m/300mm straightness and perpendicularity.



311-111



311-112



311-113

### SPECIFICATIONS

#### Metric

Order No.	Dimension (W x L x T)	Mass
311-111	90 x 110 x 25mm	1.5kg
311-112	160 x 210 x 25mm	5.0kg
311-113	260 x 310 x 30mm	14.0kg

\* 311-113 is supplied with a removable handle.

# Spring Dividers and Calipers

## SERIES 950

### FEATURES

- Spring Divider — Fully hardened and tempered joints, spring, washers and divider points.
- Outside Spring Caliper — Contact ends fully rounded to give accurate dimensions.
- Inside Spring Caliper — Ends fully rounded to give accurate contact with a workpiece.



Spring divider



Outside spring calipers



Inside spring calipers

### SPECIFICATIONS

Range	Order No.		
	Spring divider	Outside spring calipers	Inside spring calipers
6" (150mm)	950-212	950-222	950-232
8" (200mm)	950-213	950-223	950-233

# Steel Rules

## SERIES 182

### FEATURES

- Clear graduations on satin-chrome finish.
- Stainless tempered.



182-125

### SPECIFICATIONS

#### Wide Rigid Rules (thickness 3/64")

Order No.	Size	Graduations				Width	Accuracy (Length)
		1/8	1/16	1/32	1/64th		
182-101	6" (4R)	1/8	1/16	1/32	1/64th	3/4"	+ .004" / - .0035" (+0.1mm / -0.09mm)
182-102	6" (16R)	1/32	1/64	1/50	1/100th	3/4"	
182-103	6" (5R)	1/32	1/64	1/10	1/100th	3/4"	
182-104	6" (3R)	1/32	1/64	1/10	1/50th	3/4"	
182-105	6" x 150mm	1/32	1/64	1mm	0.5mm	3/4"	
182-106	6" x 150mm	1/50	1/100	1mm	0.5mm	3/4"	
182-107	6" x 150mm	1/10	1/100	1mm	0.5mm	3/4"	
182-108	6" x 150mm	1/10	1/50	1mm	0.5mm	3/4"	
182-111	150mm	1mm	0.5mm	1mm	0.5mm	19mm	
182-121	12" (4R)	1/8	1/16	1/32	1/64th	1"	
182-122	12" (16R)	1/32	1/64	1/50	1/100th	1"	
182-123	12" (5R)	1/32	1/64	1/10	1/100th	1"	
182-124	12" (3R)	1/32	1/64	1/10	1/50th	1"	
182-125	12" x 300mm	1/32	1/64	1mm	0.5mm	1"	
182-126	12" x 300mm	1/50	1/100	1mm	0.5mm	1"	
182-131	300mm	1mm	0.5mm	1mm	0.5mm	25mm	
182-241	18" (4R)	1/8	1/16	1/32	1/64	13/16"	+ .006" / - .035" (+0.15mm / -0.09mm)
182-142	18" (16R)	1/32	1/64	1/50	1/100th	13/16"	
182-143	18" (5R)	1/32	1/64	1/10	1/100th	13/16"	
182-145	18" x 450mm	1/32	1/64	1mm	0.5mm	13/16"	
182-151	450mm	1mm	0.5mm	1mm	0.5mm	30mm	
182-161	24" (4R)	1/8	1/16	1/32	1/64	13/16"	+ .007" / - .0035" (+0.18mm / -0.09mm)
182-162	24" (16R)	1/32	1/64	1/50	1/100th	13/16"	
182-163	24" (5R)	1/32	1/64	1/10	1/100th	13/16"	
182-165	24" x 600mm	1/32	1/64	1mm	0.5mm	13/16"	
182-171	600mm	1mm	0.5mm	1mm	0.5mm	30mm	

# Steel Rules

## SERIES 182

### FEATURES

- Clear graduations on satin-chrome finish.
- Stainless tempered.



182-265

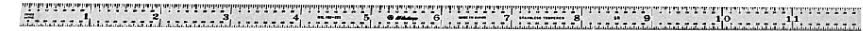

### SPECIFICATIONS

182-223

#### Full-Flexible Rules (thickness 1/64")

Order No.	Size	Graduations				Width	Accuracy (Length)
182-201	6"(4R)	1/8	1/16	1/32	1/64th	1/2"	+0.004" / -0.0035" (+0.1mm / -0.09mm)
182-202	6"(16R)	1/32	1/64	1/50	1/100th	1/2"	
182-203	6"(5R)	1/32	1/64	1/10	1/100th	1/2"	
182-204	6"(3R)	1/32	1/64	1/10	1/50th	1/2"	
182-205	6" x 150mm	1/32	1/64	1mm	0.5mm	1/2"	
182-206	6" x 150mm	1/50	1/100	1mm	0.5mm	1/2"	
182-207	6" x 150mm	1/10	1/100	1mm	0.5mm	1/2"	
182-208	6" x 150mm	1/10	1/50	1mm	0.5mm	1/2"	
182-211	150mm	1mm	0.5mm	1mm	0.5mm	12mm	+0.005" / -0.0035" (+0.13mm / -0.09mm)
182-221	12"(4R)	1/8	1/16	1/32	1/64th	1/2"	
182-222	12"(16R)	1/32	1/64	1/50	1/100th	1/2"	
182-223	12"(5R)	1/32	1/64	1/10	1/100th	1/2"	
182-224	12"(3R)	1/32	1/64	1/10	1/50th	1/2"	
182-225	12" x 300mm	1/32	1/64	1mm	0.5mm	1/2"	
182-226	12" x 300mm	1/50	1/100	1mm	0.5mm	1/2"	+0.006" / -0.0035" (+0.15mm / -0.09mm)
182-231	300mm	1mm	0.5mm	1mm	0.5mm	12mm	
182-141	18"(4R)	1/8	1/16	1/32	1/64	3/4"	
182-242	18"(16R)	1/32	1/64	1/50	1/100th	3/4"	
182-243	18"(5R)	1/32	1/64	1/10	1/100th	3/4"	
182-245	18" x 450mm	1/32	1/64	1mm	0.5mm	3/4"	+0.007" / -0.0035" (+0.18mm / -0.09mm)
182-251	450mm	1mm	0.5mm	1mm	0.5mm	18mm	
182-261	24"(4R)	1/8	1/16	1/32	1/64	3/4"	
182-262	24"(16R)	1/32	1/64	1/50	1/100th	3/4"	+0.007" / -0.0035" (+0.18mm / -0.09mm)
182-263	24"(5R)	1/32	1/64	1/10	1/100th	3/4"	
182-264	24"(3R)	1/32	1/64	1/10	1/50th	3/4"	
182-265	24" x 600mm	1/32	1/64	1mm	0.5mm	3/4"	
182-271	600mm	1mm	0.5mm	1mm	0.5mm	18mm	

## Semi-Flexible Rules

### SERIES 182

### FEATURES

- Engraved on frontside only



### SPECIFICATIONS

Inch/Metric		Graduations				Width	Accuracy (Length)	
182-301	4" x 100mm	1/2mm	1mm	1/32	1/64	1/16th	5/8"	+0.004" / -0.0035" (+0.1mm / -0.09mm)
182-302	6" x 150mm	1/2mm	1mm	1/32	1/64	1/16th	5/8"	+0.005" / -0.0035"
182-303	8" x 200mm	1/2mm	1mm	1/32	1/64	1/16th	5/8"	
182-305	12" x 300mm	1/2mm	1mm	1/32	1/64	1/16th	5/8"	+0.013mm / -0.09mm)
182-307	20" x 500mm	1/2mm	1mm	1/32	1/64	1/16th	5/8"	+0.007" / -0.0035" (+0.18mm / -0.09mm)
182-309	40" x 1000mm	1/2mm	1mm	1/32	1/64	1/16th	5/8"	+0.008"/-0.004" (+0.2mm / -0.1mm)

# Thickness/Feeler Gages

**SERIES 950, 184**

## FEATURES

- Each leaf is marked with its thickness.
- Each leaf is detachable.



184-303S

## SPECIFICATIONS

**Inch**

Range	Order No.	Type of Blade	Blade Length	Composition of leaves
.0015" - .035" (26 leaves)	<b>950-251</b>	Straight 1/2" width	3"	.002 thru .018" by .001" step plus .0015, .020, .022, .024, .025, .028, .030, .032"
.0015" - .025" (26 leaves)	<b>950-252</b>	Tapered 1/4" width at tip	3"	.002 thru .025 by .001" step plus .0015, .0025"
.0015" - .200" (15 leaves)	<b>950-254</b>	Straight 1/2" width	3"	.0015, .002, .003, .004, .006, .008, .010, .012, .015, .020, .030, .040, .075, .100, .200"
.0015" - .200" (13 leaves)	<b>950-255</b>	Straight 1/2" width	4.5"	.0015, .002, .003, .004, .006, .008, .010, .020, .030, .040, .075, .100, .200"
.0015" - .015" (9 leaves)	<b>950-256</b>	Straight 1/2" width	6"	.0015, .002, .003, .004, .006, .008, .010, .012, .015"

**Metric**

Range	Order No.	Type of Blade	Blade Length	Composition of leaves
0.05 - 1mm	<b>184-313S</b>	Straight 13mm width	100mm	28 leaves: 0.05 - 0.15mm by 0.01mm, 0.2 - 1mm by 0.05mm
	<b>184-303S</b>		150mm	28 leaves: 0.05 - 0.15mm by 0.01mm, 0.2 - 1mm by 0.05mm
0.05 - 1mm	<b>184-304S</b>	Straight 13mm width	150mm	20 leaves: 0.05 - 1mm by 0.05mm
	<b>184-305S</b>		100mm	13 leaves: 0.05 - 0.3mm by 0.05mm, 0.4 - 1mm by 0.1mm
0.05 - 1mm	<b>184-301S</b>	Straight 13mm width	150mm	13 leaves: 0.05 - 0.3mm by 0.05mm, 0.4 - 1mm by 0.1mm
	<b>184-306S</b>		100mm	10 leaves: 0.05 - 0.2mm by 0.05mm, 0.3 - 0.8mm by 0.1mm
0.05 - 0.8mm	<b>184-308S</b>	Straight 13mm width	150mm	10 leaves: 0.05 - 0.2mm by 0.05mm, 0.3 - 0.8mm by 0.1mm
	<b>184-307S</b>		Straight 13mm width	100mm
0.03 - 0.5mm	<b>184-302S</b>	Straight 13mm width		150mm

## Technical Data

Accuracy of Leaves Thickness

**Nominal Thickness**

Metric

0.01mm to less than 0.06mm:

0.06mm to less than 0.10mm:

0.10mm to less than 0.35mm:

0.35mm to less than 0.65mm:

0.65mm to less than 3.0mm:

Inch

.0015 to less than .007":

.007 to less than .015":

.015 to less than .025":

.026 to less than .030":

.031 to less than .040":

.041 to less than .075":

.076 to less than .100":

.101 to less than .200":

.200" and over :

**Tolerance**

±0.003mm

±0.004mm

±0.005mm

±0.008mm

±0.01mm

±.0002"

±.0003"

±.0004"

±.00045"

±.0005"

±.00055"

±.0006"

±.00065"

±.00075"

# Precision Levels

**SERIES 960**

## FEATURES

- High-precision longitudinal and transverse vials make it possible to check or level surfaces.
- Supplied in wooden box.

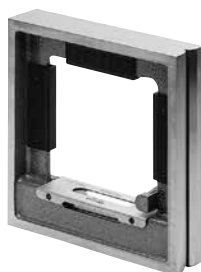

960-703



960-611

## SPECIFICATIONS

**Metric**

Order No.	Sensitivity	Accuracy	Dimensions (W x D x H)
<b>960-703</b>	0.02mm/m	±0.006mm	200 x 44 x 200mm

**Inch**

Order No.	Sensitivity	Accuracy	Dimensions		
			W	D	H
<b>960-611</b>	.0012"/12"	±.0006"	7.87"	1.73"	1.50"
<b>960-612</b>	.0006"/12"	±.0003"	7.87"	1.73"	1.50"
<b>960-613</b>	.00024"/12"	±.00017"	7.87"	1.73"	1.50"

## Wooden Box Part No.

Part No.	Spare
073112	<b>960-703</b>
063413	<b>960-611</b>
	<b>960-611</b>
	<b>960-613</b>

# Digital Universal Protractor

## SERIES 187

### Technical Data

Range:	-360° to +360°
Tolerance:	±2' (±0.03°)
Repeatability:	1'
Resolution:	1' (0.01°)
Battery:	Lithium Battery
Battery life:	2,000 hours

### Function

Presetting

### Standard Accessories

12" Blade (Code No. 187-103)  
 Battery (CR2032) (Part No. 05SAA217)  
 Clamp box for Inch Height Gage (Part No. 950749)  
 Plastic Case

### Optional Accessories

<b>187-104</b>	6" blade
<b>187-105</b>	Acute angle attachment
<b>950750</b>	Clamp box for Metric Height Gage
<b>905338</b>	Connecting cable (40" / 1m)
<b>905409</b>	Connecting cable (80" / 2m)

### FEATURES

- Data output function make it easy to see the statistical data.
- Can be attached to height gages, gage holder (950750, metric)
- Setting preset value.
- Removable blade.



### SPECIFICATIONS

Code No.	187-552
Model	BP-D300E
Blade	12" (187-103)
Display	LCD - 5 digit, (-) sign, character height 6.5mm
Measuring range	-360° ~ +360°
Resolution	1' (0.01°)
Accuracy	± 2' (±0.03°)
Repeatability	1' (0.01°)
Mass	1.45 lbs (659g)
Dust / Water protection level	IP40
Function	Zero, Direction select, Data output / Data hold, Preset, Switchable Seagesimal or Decimal Notation
Max. response speed	3 rps
Battery	Lithium battery (CR2032) 1 pc. (Part No. 05SAA217)
Battery life	2,000 hours
Alarm	Battery voltage low, Over speed error (Err)
Temperature	Operation temperature: 0 to 40°C Storage temperature: -10 to 60°C

### DIMENSIONS

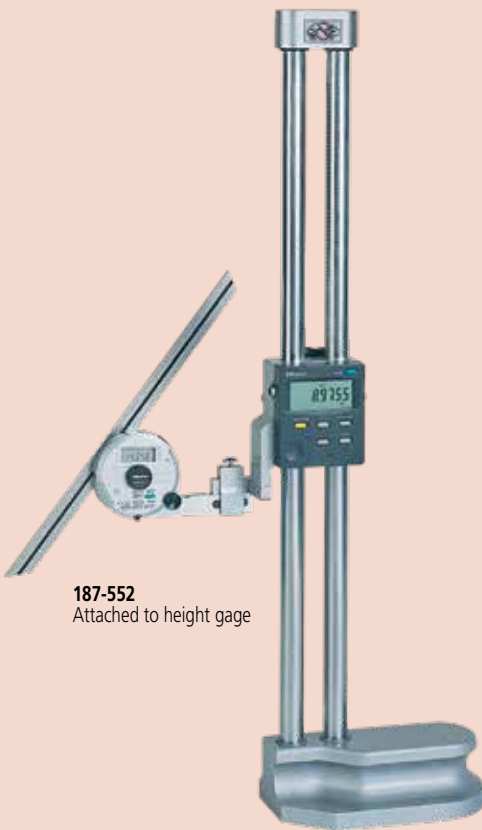
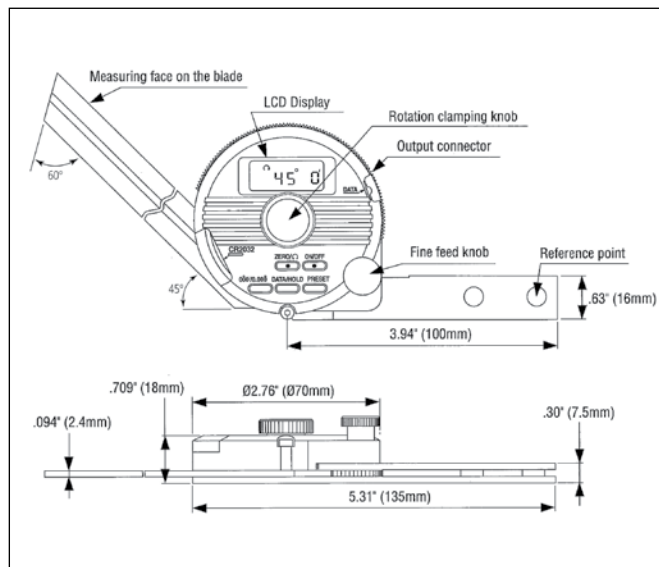

**187-552**  
Attached to height gage

# Universal Bevel Protractor

## SERIES 187

### FEATURES

- High-precision angle gage for accurate angle measurement of machines, molds, and jigs.
- Can be attached to height gages.

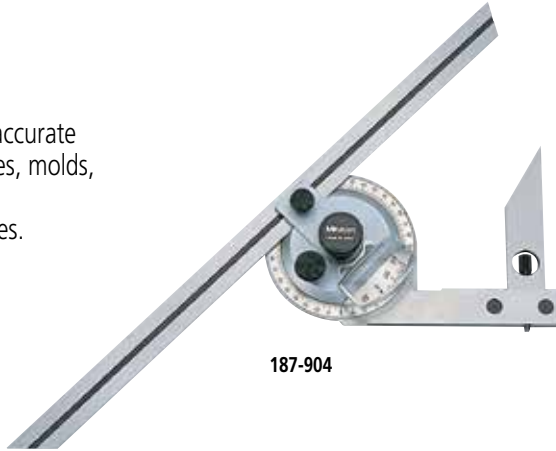

187-904

### SPECIFICATIONS

#### Universal Bevel Protractors

Graduation			
Order No.	Dial	Vernier	Remarks
187-904	1°	5 min	with 6" blade (187-104) and Clamp box for Inch Height Gages (950749)
187-906	1°	5min	with 12" blade (187-103) and Clamp box for Inch Height Gages (950749)

#### Universal Bevel Protractor Accessories and Parts

Order No.	Remarks
187-103	12" Blade
187-104	6" Blade
187-105	Acute angle attachment
950749	Clamp box for Inch Height Gages
950750	Clamp box for Metric Height Gages

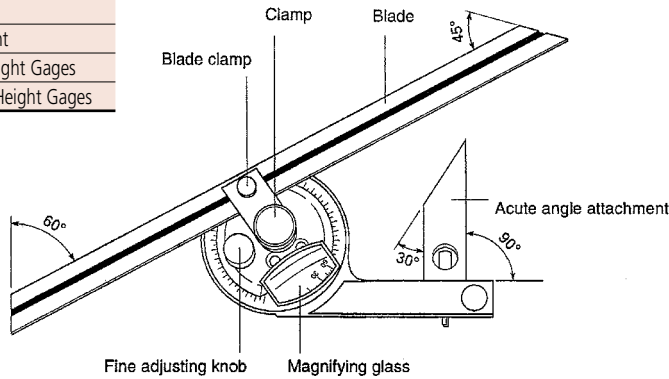

### DIMENSIONS

### Technical Data

Graduation:	5min. (0° - 90° - 0°)
Accuracy	
Vernier	±5'
Straightness	[.00016" + (.00005xL/2)]"
Parallelism	[.00016" + (.00005xL/2)]"
L = Length in inch	
Diameter:	2.56" / 70mm

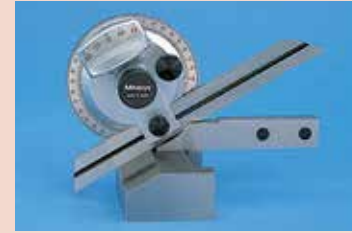

# Bevel Protractor

## SERIES 187

### FEATURES

- Consists of three sheets of stainless steel, the middle one of which is made for angle measurements.

### SPECIFICATIONS

Order No.	Graduation	Remarks
187-201	1° / 5 min	Center black knob locks the blade position Protractor Graduation: 0°-90° , 90°-0°

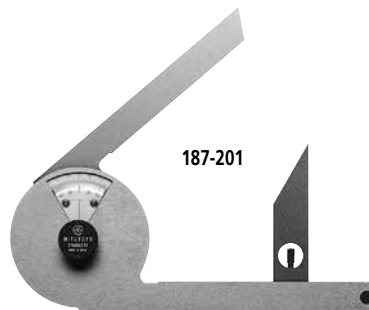

187-201

### Technical Data

Graduation:	5 min. (0° - 90° - 0°)
Blade edge angle:	30° and 60°
Diameter:	2.56" / 70mm

# Radius Gages

## SERIES 186

### FEATURES

- Radius size is stamped on each gage.
- Both concave and convex radius gages become a pair.
- With a locking clamp.

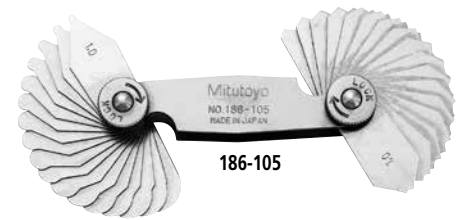

186-105

### Technical Data

Accuracy:  $\pm 0.02''$



186-110

### SPECIFICATIONS

#### Metric

Range	Order No.	Composition of leaves	Remarks
0.4 - 6mm	<b>186-110</b>	18 leaves: 0.4, 0.8, 1, 1.2, 1.5, 1.6mm, 1.75 - 3mm by 0.25mm, 3.5 - 6mm by 0.5mm	90° arc
1 - 7mm	<b>186-105</b>	34 pairs: 1 - 3mm by 0.25mm, 3.5 - 7mm by 0.5mm	180° arc
7.5 - 15mm	<b>186-106</b>	32 pairs: 7.5 - 15mm by 0.5mm	180° arc
15.5 - 25mm	<b>186-107</b>	15 pairs: 15.5 - 20mm by 0.5mm, 21 - 25mm by 1mm	180° arc

#### Inch

Range	Order No.	Composition of leaves	Remarks
1/32" - 17/64"	<b>186-103</b>	16 leaves: 1/32" - 17/64" by 64ths	90° arc
1/32" - 1/4"	<b>186-101</b>	15 pairs: 1/32" - 1/4" by 64ths	180° arc
17/64" - 1/2"	<b>186-102</b>	16 pairs: 17/64" - 1/2" by 64ths	180° arc
9/32" - 33/64"	<b>186-104</b>	16 leaves: 9/32" - 33/64" by 64ths	90° arc

# Pitch Gages

## SERIES 188, 950

### FEATURES

- Thread pitch size is stamped on each gage.
- Metric, Unified, and Whitworth screw pitch gages.

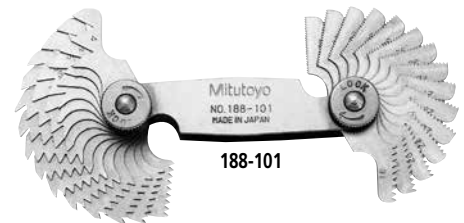

188-101

### Technical Data

TPI	Metric	Accuracy	
		Pitch (mm)	Angular (minutes)
4-6	6.35-4.23	$\pm 0.05$	$\pm 35$
7-12	3.63-2.12	$\pm 0.05$	$\pm 40$
13-25	1.95-1.02	$\pm 0.05$	$\pm 45$
26-48	0.98-0.53	$\pm 0.05$	$\pm 50$
60	0.42	$\pm 0.05$	$\pm 60$

### SPECIFICATIONS

#### Metric Screw Pitch Gages (60°)

Range	Order No.	Composition of leaves
0.25 - 2.5mm	<b>188-153</b>	28 leaves: 0.25, 0.30, 0.35, 0.40, 0.45, 0.50, 0.55, 0.60, 0.65, 0.70, 0.75, 0.80, 0.85, 0.90, 1.00, 1.10, 1.20, 1.25, 1.30, 1.40, 1.50, 1.60, 1.70, 1.75, 1.80, 1.90, 2.00, 2.50 mm
0.35 - 6mm	<b>188-130</b>	22 leaves: 0.35, 0.4, 0.45, 0.5, 0.6, 0.7, 0.75, 0.8, 1, 1.25, 1.5, 1.75, 2, 2.5, 3, 3.5, 4, 4.5, 5, 5.5, 6mm and 60° angle gage
0.4 - 7mm	<b>188-122</b>	21 leaves: 0.4, 0.5, 0.7, 0.75, 0.8, 0.9, 1, 1.25, 1.5, 1.75, 2, 2.5, 3, 3.5, 4, 4.5, 5, 5.5, 6, 6.5, 7mm
0.4 - 7mm	<b>188-121</b>	18 leaves: 0.4, 0.5, 0.75, 1, 1.25, 1.5, 1.75, 2, 2.5, 3, 3.5, 4, 4.5, 5, 5.5, 6, 6.5, 7mm

#### Unified Screw Pitch Gages (60°)

Range	Order No.	Composition of leaves
4 - 42 TPI	<b>188-111</b>	30 leaves: 4, 4 1/2, 5, 5 1/2, 6, 7, 8, 9, 10, 11, 11 1/2, 12, 13, 14, 15, 16, 18, 20, 22, 24, 26, 27, 28, 30, 32, 34, 36, 38, 40, 42 TPI
4 - 84 TPI	<b>950-253</b>	51 leaves: 4, 4 1/2, 5, 5 1/2, 6, 7, 8, 9, 10, 11, 11 1/2, 12, 13, 14, 15, 16, 18, 20, 22, 24, 26, 27, 28, 30, 32, 34, 36, 38, 40, 42, 44, 46, 48, 50, 52, 54, 56, 58, 60, 62, 64, 66, 68, 70, 72, 74, 76, 78, 80, 82, 84 TPI

Note: Metric and Unified Pitch Gage Set (**188-151**) is available. It consists of **188-122** (Metric) and **188-111** (Unified).

#### Metric and Unified Screw Pitch Gage Set (60°)

Range	Order No.	Composition of leaves
0.4 - 7mm / 4 - 42 TPI	<b>188-151</b>	51 leaves: Set of 188-122 and 188-111
0.5 - 6mm / 4 - 56 TPI	<b>188-152</b>	28 leaves: 4, 6, 8, 10, 11, 11-1/2, 12, 13, 16, 20, 28, 32, 40, 56 TPI 0.50, 0.75, 1.00, 1.25, 1.50, 1.75, 2.00, 2.50, 3.00, 3.50, 4.00, 4.50, 5.00, 6.00 mm

#### Whitworth Screw Pitch Gages (55°)

Range	Order No.	Composition of leaves
4 - 42 TPI	<b>188-101</b>	30 leaves: 4, 4 1/2, 5, 5 1/2, 6, 7, 8, 9, 10, 11, 11 1/2, 12, 13, 14, 15, 16, 18, 20, 22, 24, 26, 27, 28, 30, 32, 34, 36, 38, 40, 42 TPI
4 - 60 TPI	<b>188-102</b>	28 leaves: 4, 4 1/2, 5, 6, 7, 8, 9, 10, 11, 12, 13, 14, 16, 18, 19, 20, 22, 24, 25, 26, 28, 30, 32, 34, 36, 40, 48, 60 TPI

# Radius Gages-Sets

## SERIES 186

### FEATURES

Radius Gages are recommended for checking or laying out concave or convex radii. An individual gage for each dimension makes it possible to verify radius or fillet dimensions easier, faster and more accurately in machining, layout, inspection and pattern-making work. The measuring surfaces are precisely finished with smooth, accurate edges. Radius gages are available separately or in six sets. Each radius gage has five measuring locations, and it is identified with its particular radius dimensions. The gages have a satin or dull-chrome finish.

The holding cases, provided to protect the sets of radius gages, have indexed pockets to facilitate the selection of the proper size gage. A 4" long holder is furnished with Set No. 186-901 to make it possible to check radii in confined or hard-to-reach locations.



186-901

### SPECIFICATIONS

#### Metric

Order No.	No. of Leaves	Sizes	Remarks
186-902	26	0.5 - 13mm by 0.5mm	90° arc

#### Inch

Order No.	No. of Leaves	Sizes	Remarks
186-901	25	1/64"-17/64" by 64ths and 9/32"-1/2" by 32nds	Holder
186-903	17	1/64"-17/64" by 64ths	
186-904	8	9/32"-1/2" by 32nds	
186-905	8	9/16"-1" by 16ths	Holder
186-906	26	.010-.030" by .005" .040-.100" by .010" .120-.300" by .020" .350-.500" by .050"	Holder
186-907	10	.550-1" by .050"	

Replacement handle: 950753

Accuracy:  $\pm .0016" / 0.04\text{mm}$

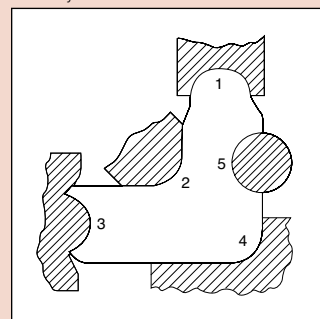

5 concave and convex radii per leaf.

#### Decimal

Radius	Part No.	Radius	Part No.
.010"	211798	.240"	211816
.015"	211799	.260"	211817
.020"	211800	.280"	211818
.025"	211801	.300"	211819
.030"	211802	.350"	211820
.040"	211803	.400"	211821
.050"	211804	.450"	211822
.060"	211805	.500"	211823
.070"	211806	.550"	211824
.080"	211807	.600"	211825
.090"	211808	.650"	211826
.100"	211809	.700"	211827
.120"	211810	.750"	211828
.140"	211811	.800"	211829
.160"	211812	.850"	211830
.180"	211813	.900"	211831
.200"	211814	.950"	211832
.220"	211815	1.000"	211833

#### Fraction

Radius	Part No.	Radius	Part No.
1/64"	201441	5/16"	201459
1/32"	201442	11/32"	201460
3/64"	201443	3/8"	201461
1/16"	201444	13/32"	201462
5/64"	201445	7/16"	201463
3/32"	201446	15/32"	201464
7/64"	201447	1/2"	201465
1/8"	201448	9/16"	211790
9/64"	201449	5/8"	211791
5/32"	201450	11/16"	211792
11/64"	201451	3/4"	211793
3/16"	201452	13/16"	211794
13/64"	201453	7/8"	211795
7/32"	201454	15/16"	211796
15/64"	201455	1"	211797
1/4"	201456		
17/64"	201457		
9/32"	201458		



# Digital Protractor

## SERIES 950

### FEATURES

These digital protractors present inclination values on an easy-to-read LCD. The measurements are generated by an electronic gravity sensor and processed by the latest low-power electronic circuit technology.

- Full 360° range (90° x 4).
- Machined aluminum frame.
- Alternate reference (zero).
- Reading hold.
- Simple calibration requiring no special fixtures.
- Display remains upright to view at all angles. (950-317, Pro 360 Model).
- RS232C output. (950-318 Pro 3600 Model).
- Supplied in fitted carrying case.



Front View



950-317 Back View



950-318 Back View

### Optional Accessories

**50AAA983A** RS-232C Output cable w/foot switch

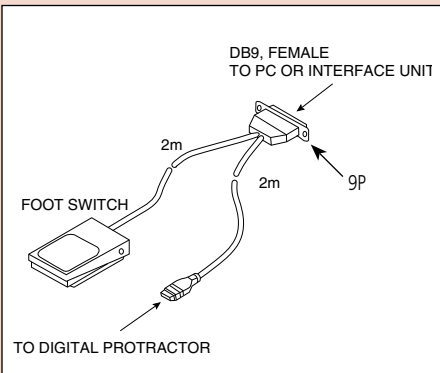

**50AAA983A** RS-232C Output cable w/foot switch 10P-9P

### SPECIFICATIONS

Order No.	950-317	950-318
Model	Pro 360	Pro 3600
Range	360° (90°x4)	360° (90°x4)
Resolution	0.1°	0.01° (0° to 9.99°) 0.1° (10° to 90°)
Accuracy	±0.1° Level ±10°, Plumb ±10° ±0.2° Maximum error	±0.05° (0° to 10°) ±0.1° (80° to 90°) ±0.2° (10° to 80°)
Repeatability	±0.1°	±0.05°
Cross Axis Error	Minimal	Minimal
Battery Life	500 Hrs. Standard 9-Volt Battery	500 Hrs. Standard 9-Volt Battery
Temperature Operation	-5°C to 50°C (23° to 122°F)	-5°C to 50°C (23° to 122°F)
Storage	-20°C to 65°C (-4°F to 149°F)	-20°C to 65°C (-4°F to 149°F)
Weight	289g (10.2oz.)	295g (10.4oz.)
Output	N/A	RS-232C Compatible
Standard Accessories	Plastic Case	Plastic Case

±Represents clockwise or counter-clockwise slope.

### DIMENSIONS

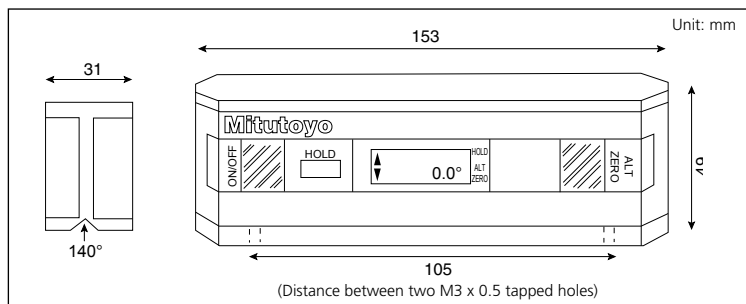

# Digital Hand Tachometers

## SERIES 982

### FEATURES

- New digital hand tachometers are compact and easy to handle.
- NIST certification is supplied with each digital hand tachometer.
- Model PH-200LC (982-552) has laser diode detection and a combination of contact and non-contact measurement.
- Supplied with plastic carrying case.



982-551



982-552

### SPECIFICATIONS

Order No.	982-551	982-552
Model No.	PH-100A	PH-200LC
Revolution per minute	1.0 – 25,000 rpm	—
Rotation speed	—	Non-contact: 6.0 – 99,999 rpm; Contact: 6.0 – 25,000 rpm
Measuring accuracy	1.0 – 599.9rpm: $\pm 1$ rpm, 600.0 – 25,000 rpm: Revolution $\pm 0.006\%$ and $\pm 0.5$ digit Surface, Speed, Length $\pm 0.4\%$ and 1 digit	6.0 – 599.9 rpm: $\pm 1$ rpm, 600.0 – 99,999 rpm $\pm 0.006\%$ and $\pm 0.5$ digit $\pm 0.4\%$ and $\pm 1$ digit
Detection	Optical coupler, 20 pulses per revolution	Laser diode
Outside dimensions	4.83" L x 2.52" W x 1.24" H (122.5mm x 64mm x 31.5mm)	4.55" L x 2.52" W x 1.24" H Overall length with contact adapter: 149mm
Mass	170 g	160 g
Power	Battery: AA 3 pcs.	Battery: AA 3 pcs.

### Optional Accessories for Digital Hand Tachometers

Order No.	Description	Dimension	Drawing
010049	Cone Adapter, Standard	D = 1/2"	
010051	Cone Adapter, 3/4"	D = 3/4"	
010052	Cone Adapter, 1-1/4"	D = 1-1/4" d = 1/2"	
010053	Funnel Adapter, Standard	D = 1/2"	
010054	Funnel Adapter, 3/4"	D = 3/4"	
010055	Measuring Wheel FPM (6" cir), Standard	D = 1.91"	
010056	Measuring Wheel FPM (12" cir)	D = 3.82"	
010057	Measuring Wheel YPM (0.1 yard cir)	D = 1.15"	
010058	Measuring Wheel MPM (0.1 meter cir)	D = 1.25"	
010059	Reflective Tabs 1/2" square (35 pcs)		
010060	Extension Shaft (3" length)		



### DIMENSIONS

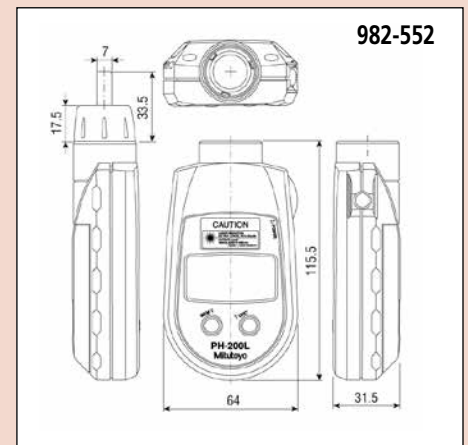
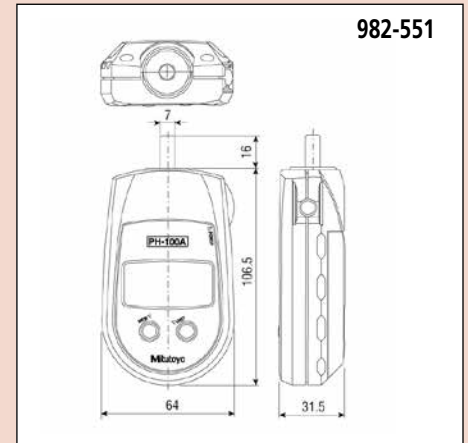

# Bench Center

## SERIES 967

### Technical Data

Spindle tip material: Hardened Steel

### FEATURES

- Used with a dial test indicator (optional), the bench center provides precision measurement of concentricity verification on cylindrical workpieces.
- With an indicator clamp. (Holding stem diameter: 9.53mm / .375")

967-201-10



### DIMENSIONS

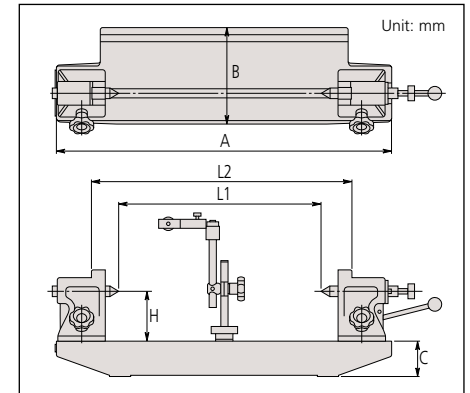

Order No.	A	B	C	H	L1	L2
967-203-10	310	113	40	50	150	220
967-201-10	500	144	55	75	300	400
967-204-10	700	202	80	100	450	590
967-202-10	900	222	100	125	600	730

### Standard Accessories:

**56AAK066** Indicator rod assembly  
**967-201-10**  
**967-203-10**

**56AAK961R** Indicator rod assembly

**967-202-10**  
**967-204-10**

### Optional Accessories:

**56AAJ988** Special attachment for mounting **967-201-10** in vertical position.

**56AAJ987** Special attachment for mounting **967-203-10** in vertical position.

### SPECIFICATIONS

Order No.	Center-to-Center	Workpiece Capacity Diameter	Max. Weight Hold	Parallelism of Centers	Flatness of Surface	Attachment Diameter	Mass (kg)
967-203-10	5.9" / 150mm	3.8"	15.5lbs.(7kg)	.00024"	.0005"	3/8", 8mm	7
967-201-10	11.8" / 300mm	5.8"	35 lbs. (16kg)	.0004"	.0006"	3/8", 8mm	13
967-204-10	17.7" / 450mm	7.8"	44 lbs. (20kg)	.0004"	.0007"	3/8", 8mm	60
967-202-10	23.6" / 600mm	9.8"	66 lbs. (30kg)	.00047"	.00075"	3/8", 8mm	70

# Granite Surface Plate Accessories

## SERIES 517

These accessories are made from the same high-quality black granite as Mitutoyo surface plates, allowing flexibility in work holding and positioning.

### SPECIFICATIONS

**Angle Blocks** with or without inserts

Grade	Laboratory*			Master**		
	2 Face	4 Face		2 Face	4 Face	
no inserts		w/ inserts	no inserts		w/ inserts	
4 x 4 x 4"	<b>517-767</b>	<b>517-761</b>	<b>517-773</b>	<b>517-867</b>	<b>517-861</b>	<b>517-873</b>
6 x 6 x 6"	<b>517-768</b>	<b>517-762</b>	<b>517-774</b>	<b>517-868</b>	<b>517862</b>	<b>517-874</b>

\*Laboratory overall accuracy: .000025" per 6".

\*\*Master overall accuracy: .000050" per 6".

### Parallels

Grade	Pair Accuracy	Laboratory		Master		
		2 Face	4 Face	Accuracy	2 Face	4 Face
.75 x 1 x 6"	.00003"	<b>517-755</b>	<b>517-750</b>	.00006"	<b>517-855</b>	<b>517-850</b>
.75 x 1.5 x 9"	.00004"	<b>517-756</b>	<b>517-751</b>	.00008"	<b>517-856</b>	<b>517-851</b>
1 x 2 x 12"	.00006"	<b>517-757</b>	<b>517-752</b>	.0001"	<b>517-857</b>	<b>517-852</b>

### V-Blocks Matching Pair

V-1 type have matching accuracy on "V" from the bottom face only. V-5 type have four face matching accuracy plus "V".

Grade	Laboratory*		Master**	
	V-1	V-5	V-1	V-5
2 x 2 x 2.5"	<b>517-787</b>	<b>517-783</b>	<b>517-887</b>	<b>517-883</b>
3 x 3 x 3"	<b>517-788</b>	<b>517-784</b>	<b>517-888</b>	<b>517-884</b>
6 x 6 x 6"	<b>517-789</b>	<b>517-785</b>	<b>517-889</b>	<b>517-885</b>

\*Laboratory overall accuracy: .00005" per 6".

\*\*Master overall accuracy: .0001" per 6"

Angle Blocks



**517-862**  
(without inserts)

**517-884** V-Blocks (matching pair)



**517-852**  
Parallels  
(in pairs)

# Mitutoyo

# Black Granite Surface Plate

**SERIES 517**

## FEATURES

- Natural granite seasoned for thousands of years is free from deterioration or dimensional change over time.
- Granite surface plate has many advantages over cast iron surface plates: Twice as hard as cast iron. Minimal changes in dimension due to temperature changes. Free from wringing, so there is no interruption of work. Free from burrs or protrusions because of the fine grain structure and insignificant stickiness; this ensures a high degree of flatness over a long service life and causes no damage to other parts or instruments.
- Trouble-free operation for use with magnetic materials.
- Long life and rust-free, resulting in low maintenance costs.
- Mitutoyo granite surface plates meet or exceed federal specification GGG-P-463c. Each surface plate is shipped with a Certificate of Accuracy which guarantees its accuracy and verifies its traceability to NIST.
- All plates from 48" x 108" and larger are machine base gray granite. Smaller plates are black granite.
- Surface plates, to size of specifications other than standard, available by special order.
- Surface plates, with the bolt screws, available by special order.
- All Mitutoyo surface plates shipped F.O.B. Escondido, CA.

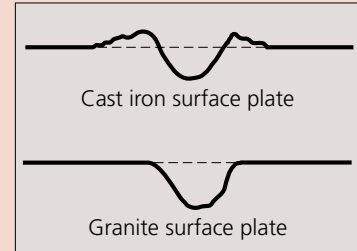

## SPECIFICATIONS

**Inch** 100 lbs.-Load / sq. ft. no ledge

Size	AA Laboratory Grade				A Inspection Grade				B Shop Grade			
	H	Acc.*	Order No.	Wt. (lbs)	H	Acc.*	Order No.	Wt. (lbs)	H	Acc.*	Order No.	Wt. (lbs)
8 x 12"	3"	50	<b>517-700</b>	30	2"	100	<b>517-800</b>	25	2"	200	<b>517-900</b>	25
9 x 12"	3"	50	<b>517-701</b>	40	3"	100	<b>517-801</b>	40	2"	200	<b>517-901</b>	30
12 x 12"	3"	50	<b>517-702</b>	50	3"	100	<b>517-802</b>	50	3"	200	<b>517-902</b>	50
12 x 18"	4"	50	<b>517-703</b>	100	4"	100	<b>517-803</b>	100	4"	200	<b>517-903</b>	100
18 x 18"	4"	50	<b>517-704</b>	150	4"	100	<b>517-804</b>	150	3"	200	<b>517-904</b>	100
18 x 24"	4"	65	<b>517-705</b>	200	4"	130	<b>517-805</b>	200	4"	260	<b>517-905</b>	200
24 x 24"	5"	70	<b>517-706</b>	310	4"	140	<b>517-806</b>	259	3"	280	<b>517-906</b>	200
24 x 30"	5"	75	<b>517-707</b>	400	5"	150	<b>517-807</b>	400	4"	300	<b>517-907</b>	300
24 x 36"	6"	85	<b>517-708</b>	600	5"	170	<b>517-808</b>	500	4"	340	<b>517-908</b>	400
24 x 48"	8"	150	<b>517-709</b>	1000	6"	300	<b>517-809</b>	800	5"	600	<b>517-909</b>	650
30 x 36"	6"	100	<b>517-710</b>	800	5"	200	<b>517-810</b>	600	5"	400	<b>517-910</b>	600
30 x 48"	8"	150	<b>517-711</b>	1300	6"	300	<b>517-811</b>	1000	6"	600	<b>517-911</b>	1000
30 x 60"	12"	200	<b>517-712</b>	1900	10"	500	<b>517-812</b>	1535	8"	1000	<b>517-912</b>	1150
36 x 36"	6"	100	<b>517-713</b>	900	5"	200	<b>517-813</b>	780	5"	400	<b>517-913</b>	700
36 x 48"	8"	150	<b>517-714</b>	1500	6"	300	<b>517-814</b>	1200	6"	600	<b>517-914</b>	1200
36 x 60"	12"	200	<b>517-715</b>	2850	10"	400	<b>517-815</b>	2350	8"	800	<b>517-915</b>	1900
36 x 72"	12"	250	<b>517-716</b>	3400	10"	500	<b>517-816</b>	2850	8"	1000	<b>517-916</b>	2300
48 x 48"	8"	200	<b>517-717</b>	2025	6"	400	<b>517-817</b>	1525	6"	800	<b>517-917</b>	1500
48 x 60"	12"	250	<b>517-718</b>	3800	10"	500	<b>517-818</b>	3150	8"	1000	<b>517-918</b>	2525
48 x 72"	12"	300	<b>517-719</b>	4500	10"	600	<b>517-819</b>	3800	8"	1200	<b>517-919</b>	3050
48 x 84"	14"	350	<b>517-720</b>	6150	12"	700	<b>517-820</b>	5325	10"	1400	<b>517-920</b>	4450
48 x 96"	14"	400	<b>517-721</b>	7000	12"	800	<b>517-821</b>	6050	10"	1600	<b>517-921</b>	5150
48 x 108"	14"	500	<b>517-722</b>	7900	12"	1000	<b>517-822</b>	6830	10"	2000	<b>517-922</b>	5700
48 x 120"	18"	700	<b>517-723</b>	11300	16"	1400	<b>517-823</b>	10160	14"	2800	<b>517-923</b>	8800
48 x 144"	18"	800	<b>517-724</b>	13500	16"	1600	<b>517-824</b>	12200	14"	3200	<b>517-924</b>	10500
60 x 60"	14"	250	<b>517-725</b>	5500	12"	500	<b>517-825</b>	4800	10"	1000	<b>517-925</b>	4000
60 x 72"	14"	350	<b>517-726</b>	6600	12"	700	<b>517-826</b>	5750	10"	1400	<b>517-926</b>	4900
60 x 96"	14"	500	<b>517-727</b>	8800	12"	1000	<b>517-827</b>	7600	10"	2000	<b>517-927</b>	6500
60 x 120"	16"	700	<b>517-728</b>	11050	14"	1400	<b>517-828</b>	11100	12"	2800	<b>517-928</b>	9800
60 x 144"	18"	900	<b>517-729</b>	16950	16"	1800	<b>517-829</b>	15100	14"	3600	<b>517-929</b>	14200
72 x 72"	14"	400	<b>517-730</b>	8000	12"	800	<b>517-830</b>	7000	10"	1600	<b>517-930</b>	5700
72 x 96"	16"	500	<b>517-731</b>	12025	14"	1000	<b>517-831</b>	10800	12"	2000	<b>517-931</b>	9200
72 x 120"	16"	700	<b>517-732</b>	15070	14"	1400	<b>517-832</b>	13400	12"	2800	<b>517-932</b>	11400
72 x 144"	18"	1000	<b>517-733</b>	20300	16"	2000	<b>517-833</b>	18100	14"	4000	<b>517-933</b>	15900

\* Accuracies shown in microinches (µin)

# Black Granite Surface Plate

## SERIES 517

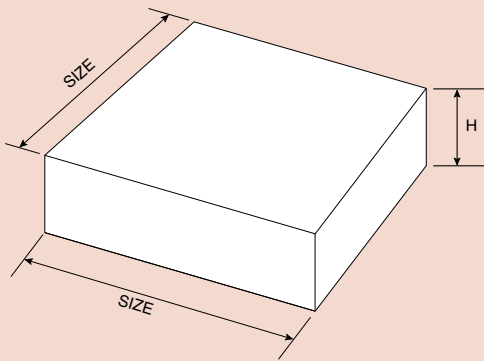

**Inch** 50 lbs.-Load / sq. ft. no ledge

Size	AA Laboratory Grade				A Inspection Grade				B Shop Grade			
	H	Acc.	Order No.	Wt.	H	Acc.	Order No.	Wt.	H	Acc.	Order No.	Wt.
8 x 12"	2"	50	<b>517-740</b>	25	2"	100	<b>517-840</b>	25	2"	200	<b>517-940</b>	25
12 x 18"	3"	50	<b>517-741</b>	80	3"	100	<b>517-841</b>	80	2"	200	<b>517-941</b>	60
18 x 24"	4"	65	<b>517-742</b>	200	3"	130	<b>517-842</b>	165	2"	260	<b>517-942</b>	100
24 x 36"	5"	85	<b>517-743</b>	500	4"	170	<b>517-843</b>	400	3"	340	<b>517-943</b>	300
36 x 48"	6"	150	<b>517-746</b>	1200	5"	300	<b>517-846</b>	1000	4"	600	<b>517-946</b>	800

## Steel Stands

### SERIES 517

Steel stands for supporting black granite surface plates, at working levels, are available either stationary or with casters. Sizes and weights are given below.

### SPECIFICATIONS

Size	Stationary		With Casters	
	Order No.	Wt.	Order No.	Wt.
12 x 18"	<b>517-950</b>	42lbs	<b>517-950-1</b>	46lbs
18 x 18"	<b>517-951</b>	46lbs	<b>517-951-1</b>	50lbs
18 x 24"	<b>517-952</b>	50lbs	<b>517-952-1</b>	56lbs
24 x 24"	<b>517-954</b>	65lbs	<b>517-954-1</b>	69lbs
24 x 30"	<b>517-955</b>	70lbs	<b>517-955-1</b>	74lbs
24 x 36"	<b>517-956</b>	73lbs	<b>517-956-1</b>	77lbs
24 x 48"	<b>517-957</b>	90lbs	<b>517-957-1</b>	94lbs
30 x 36"	<b>517-960</b>	85lbs	<b>517-960-1</b>	89lbs
30 x 48"	<b>517-961</b>	95lbs	<b>517-961-1</b>	99lbs
30 x 60"	<b>517-962</b>	105lbs	<b>517-962-1</b>	109lbs
36 x 36"	<b>517-963</b>	95lbs	<b>517-963-1</b>	99lbs
36 x 48"	<b>517-964</b>	105lbs	<b>517-964-1</b>	109lbs
36 x 60"	<b>517-965</b>	160lbs	<b>517-965-1</b>	164lbs
36 x 72"	<b>517-966</b>	180lbs	<b>517-966-1</b>	184lbs
48 x 48"	<b>517-967</b>	190lbs	<b>517-967-1</b>	194lbs
48 x 60"	<b>517-968</b>	200lbs	<b>517-968-1</b>	204lbs
48 x 72"	<b>517-969</b>	205lbs	<b>517-969-1</b>	209lbs
48 x 84"	<b>517-970</b>	320lbs	<b>517-970-1</b>	324lbs
48 x 96"	<b>517-971</b>	335lbs	<b>517-971-1</b>	339lbs
48 x 108"	<b>517-972</b>	350lbs	<b>517-972-1</b>	354lbs
48 x 120"	<b>517-973</b>	365lbs	<b>517-973-1</b>	369lbs
48 x 144"	<b>517-974</b>	430lbs	<b>517-974-1</b>	434lbs
60 x 60"	<b>517-975</b>	245lbs		
60 x 72"	<b>517-976</b>	340lbs		
60 x 96"	<b>517-977</b>	375lbs		
60 x 120"	<b>517-978</b>	455lbs		
60 x 144"	<b>517-979</b>	480lbs		
72 x 72"	<b>517-980</b>	380lbs		
72 x 96"	<b>517-981</b>	465lbs		
72 x 120"	<b>517-982</b>	510lbs		
72 x 144"	<b>517-983</b>	530lbs		

48x72 and smaller include keepers to prevent the surface plate from being pushed off the stand.

Note: Stands can only be purchased with granite surface plates. Working height is 36" unless otherwise specified.



# MITUTOYO CALIBRATION SERVICES

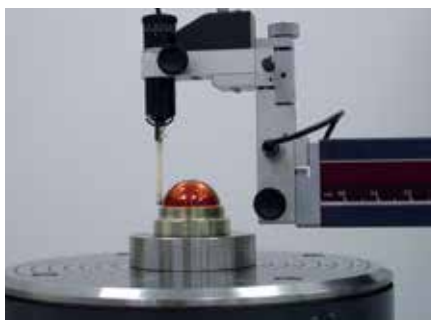
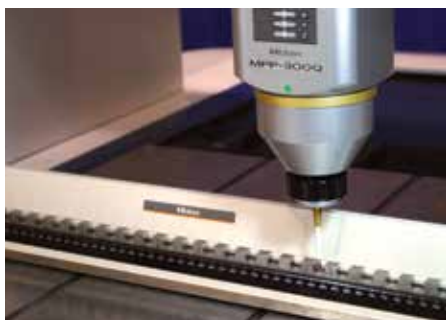

Mitutoyo America has expanded three-dimensional calibration and inspection services at our new precision measurement facility located in our corporate headquarters in Aurora, IL. Equipped with multiple Mitutoyo Legex CMMs, along with high-accuracy vision and form measuring instruments, our laboratory offers accredited dimensional measurement services with uncertainty as low as  $0.25\ \mu\text{m}$  (10  $\mu\text{inches}$ ). And for form measurement, our uncertainty goes as low as 5 nanometers (0.2  $\mu\text{inches}$ ).

Our experienced staff is ready for your challenges – we specialize in specialty gage calibration, complex prototype or master parts, specialty and custom-built 3D gages, and long length standards such as ball bars, step gages and gage blocks. We can also assist you in the validation of your measurement processes by providing accredited reference values on your parts.

Mitutoyo America calibration and inspection services are accredited to ISO/IEC 17025 by A2LA (Certificate 0750.01). We welcome customer tours of our laboratory.

If you have any questions or would like more information regarding Mitutoyo Calibration Services, contact: [mim@mitutoyo.com](mailto:mim@mitutoyo.com)

