

# Surface Roughness Measuring System SURFTEST SV-3100 Series

Bulletin No. 2068



Improve total throughput and perform highly accurate surface roughness measurement with best-in-class positioning speed and precision

**Mitutoyo**

# Powerful Support for Greater Efficiency in Surface Roughness Measurement!

## Shorter measurement time

### Drive unit (X-axis): 80mm/s, column (Z2-axis): 20mm/s

The faster drive speed shortens the total measurement time.

### Auto-leveling table (option)

Leveling is performed automatically even for complex measurement surfaces, dramatically reducing setting time.

## Eliminate human error

### Column (Z2-axis) incorporates an ABS (absolute origin) scale

Improved repeatability for operations such as continuous automatic measurement of small holes in the vertical direction or repetitive measurement of difficult-to-position parts.

### Additional automation can be achieved using a Y-axis table and a rotary table (option)

Automatic measurement of large numbers of parts one at a time or many parts at different locations on the worktable can be performed by attaching accessories such as a Y-axis table and a rotary table to dramatically reduce the manual workload.

## High durability

### Ceramic guides

To ensure that the drive unit (X-axis) maintains its straightness for a long time, the tester uses ceramic guides that have excellent wear characteristics and minimal deformation over time. The use of ceramic also provides a maintenance-free design because lubrication with oil to prevent corrosion is not required.



## High accuracy linear encoders on X/Z2-axes

The drive unit (X-axis) and column (Z2-axis) are equipped with high-accuracy linear encoders (ABS type on Z2-axis) enabling fully automatic measurement combining vertical and horizontal movement. This improves reproducibility of continuous automatic measurement of small holes in the vertical direction and repeated measurement of parts which are difficult to position.

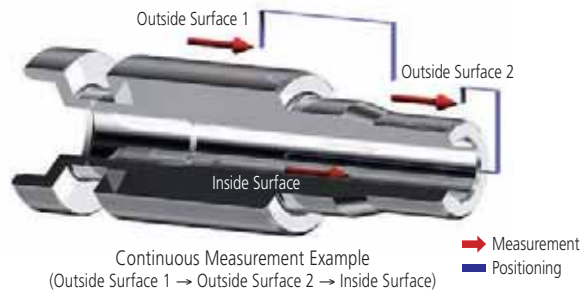

## Wide range of operation options from high-speed drive to fine manual adjustment

In addition to the shorter traversing time achieved by the high-speed drive performance (drive unit (X-axis): 80mm/s, column (Z2-axis): 20mm/s), the tester also allows the fine manual adjustment needed for positioning when measuring very small holes.

### Remote Control Box



### Overview of using fine adjusters for small hole measurement



Y- and Z-axis alignment can be performed using the column (Z2-axis) fine vertical positioning and accessories such as the cross stage (option).



Measurement start positioning using the fine adjustment function of the drive unit (X-axis).

## Safety Functions to Protect Operator, Measuring Unit, and Workpiece

- To enhance safety during fast traverse, the Z-axis detector unit incorporates a safety device (Automatic Stop-On-Collision Mechanism) and the new remote control box features an easily reached emergency stop switch next to the drive speed control knob.



- All detector and drive unit cables are housed inside the main unit to eliminate any risk of abrasion and guarantee trouble free, high-speed operation.



## Product range includes models with a tilting mechanism on the drive unit (X-axis).

Models with a tilting mechanism on the drive unit (X-axis) are valuable in situations such as when measuring on inclined surfaces or on heavy workpieces that are difficult to align properly.



Model No.	Drive unit (X-axis)	Z2-axis (column) moving range	Base size
SV-3100S4	100mm	300mm	600x450mm
SV-3100H4		500mm	1000x450mm
SV-3100S8	200mm	300mm	600x450mm
SV-3100H8		500mm	1000x450mm

\* Models are also available with or without the drive unit (X-axis) tilting mechanism.

# Surface Roughness/Contour Analysis Software: FORMTRACEPAK

## ● Surface Roughness analysis function

FORMTRACEPAK can perform surface roughness analyses that conform to various standards such as ISO, JIS ANSI, and VDA. For comparing the measurement values with the tolerance limits, you can use the 16% rule or the maximum value rule. Furthermore, since FORMTRACEPAK comes with parameter calculation functions as well as a rich set of graphic analysis functions, it can be widely utilized for everything from routine quality control to R&D applications. It also includes many other functions, such as the function for eliminating (compensating) shapes, such as slopes and R-surface, and a data deletion function.

## ● Microscopic contour analysis function

This function can calculate steps and surface areas from the roughness data. Furthermore, as with the contour analysis function, a rich set of calculation commands that combine various elements, such as points, lines, and circles, to calculate angles, pitches, and distances are provided as standard features.

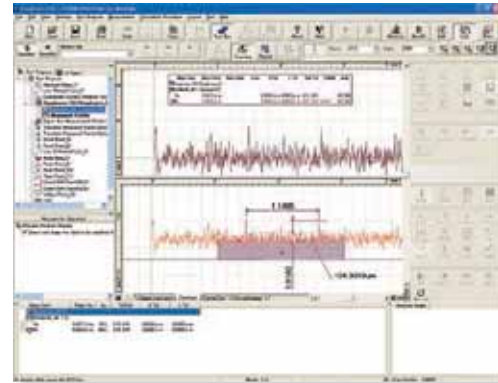

## ● Simple input using drawing symbols

You can easily set up cumbersome measurement conditions by simply entering data according to the drawing symbols of the ISO/JIS roughness standard.

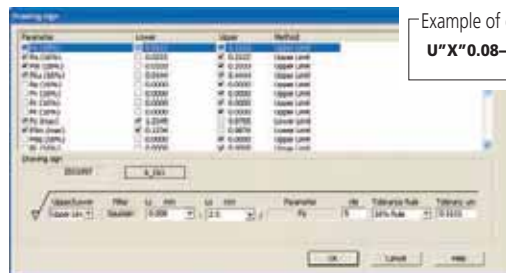
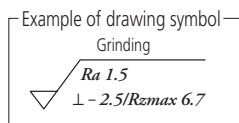

Example of entering data  
 $U^*X^*0.08-0.8/Rz8max 3.3$

## ● Reference length dialog box

When setting up the reference length in a measurement condition, you can display the standard values defined by the ISO/JIS standards by selecting the applicable standard.

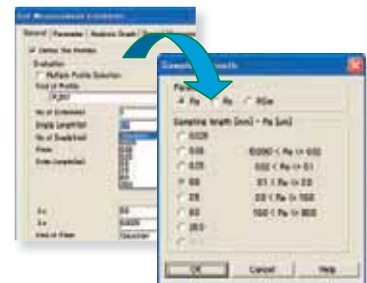

## ● Multiple-point measurement function

You can easily create a part program that measures multiple points by simply entering a shift.

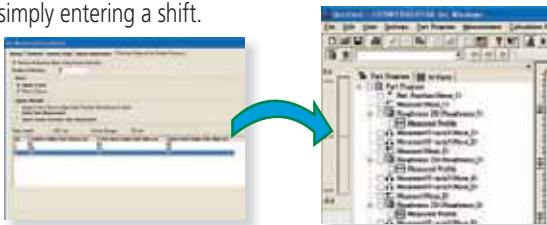

## ● Analysis function using multiple-point measurements

For a workpiece that cannot be measured over the evaluation distance specified by a standard, you can calculate the roughness parameter from the data obtained by measuring multiple points, and compare the measurement data with the tolerance limits using the 16% rule, for example.

## ● Analysis condition modification with a preview function

You can easily modify various types of analysis conditions such as the standard to be used, curve type, and filter. Furthermore, before eliminating (compensating) shapes such as slopes, R-surfaces, and parabolas, the preview function allows you to check the impact on the spot.

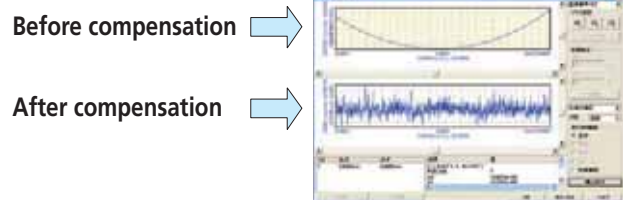

## ● R-surface automatic measurement function

Based on the preliminary measurement results, you can automatically measure an R-surface by allocating measurement distances using the peak or bottom of the R-surface as the reference.

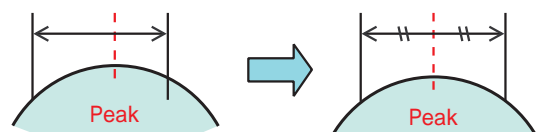

## Integrated layout

You can use simple operations to lay out graphics obtained from measurements as well as measurement results for surface roughness, contour, and roundness on a single page.

Furthermore, since the program now allows you to specify a saved file and paste it, you can easily paste results from multiple files.

\*Note that the optional ROUNDPAK roundness/cylindricity analysis program is required. (Ver. 7 or higher)

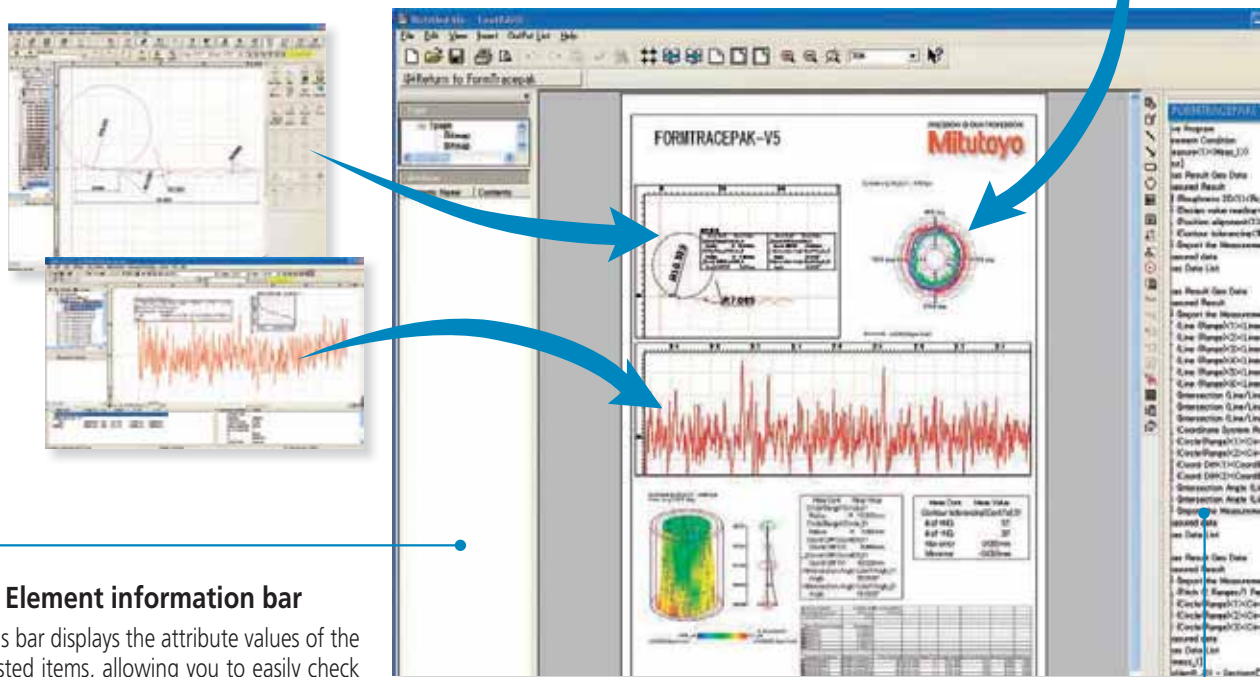
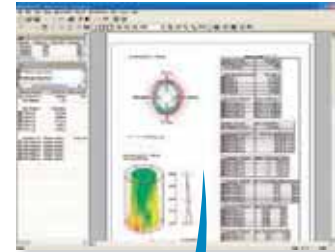

### ● Element information bar

This bar displays the attribute values of the pasted items, allowing you to easily check the contents of the pasted measurement data files.

### ● System layout printing

By simply selecting the items to be output, you can automatically lay out the page to be printed.

Use this feature when you wish to simplify the printing task.

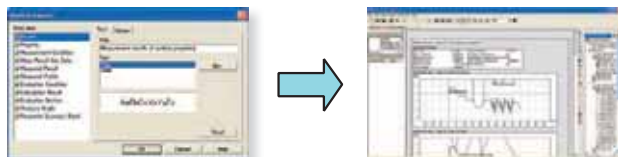

### ● Element insertion bar

Using the mouse to drag and drop the analysis content displayed in the element insertion bar, you can paste it onto the layout. From the contour analysis result, you can also select the analysis result for a circle or line alone and paste it in position.

### ● Saving the result as a web page

Since you can save the result in html or mhtml format, which can be displayed using Internet Explorer or Microsoft Word, you can check the result even on a PC in which no layout-editing program is installed.

### ● Report creation function

You can freely assemble measurement results/conditions/graphics as well as comments/circles/lines/arrows, and print them out in a measurement result report. Furthermore, since you can paste bitmap files, you can also add a workpiece image or company logo to the layout.

You can also save the created layout and use it again later for similar measurements.

# Optional Accessories for Automatic Measurement

## Y-axis table: 178-097

Enables efficient, automatic measurement of multiple aligned workpieces and multiple points on a single measurement surface.

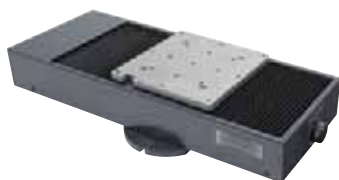

Travel range	200mm
Resolution	0.05μm
Positioning accuracy	±3μm
Drive speed	Max. 80mm/s
Maximum load	50kg
Mass	28kg



## Rotary Table θ1-axis table: 12AAD975\*

For efficient measurement in the axial/transverse directions. When measuring a cylindrical workpiece, automatic alignment can be performed in combination with the Y-axis table.

\*θ1-axis mounting plate (**12AAE630**) is required when directly installing on the base of the SV-3100.

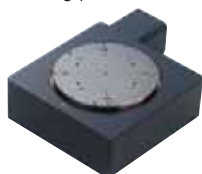

Displacement	360°
Resolution	0.004°
Maximum load	12kg
Rotational speed	Max. 10°/s
Mass	7kg



## Rotary Table θ2-axis unit: 178-078\*

You can measure multiple points on a cylindrical workpiece and automate front/rear-side measurement.

\*θ2-axis mounting plate (**12AAE718**) is required when directly installing on the base of the SV-3100.



Displacement	360°
Resolution	0.0072°
Maximum load (loading moment)	4kg (343 N·cm or less)
Rotational speed	Max. 18°/s
Mass	5kg



## Centering chuck (ring operated): 211-032

This chuck is useful when measuring small workpieces. You can easily clamp them with its knurled ring.



Retention range	Inner latch	OD: ø1 - ø36mm
	Inner latch	ID: ø16 - ø69mm
	Outer latch	OD: ø25 - ø79mm
Dimensions	ø118x41mm	
Mass	1.2kg	

## Micro-chuck: 211-031

This chuck is suitable for clamping extra-small diameter workpieces (ø1 mm or less), which cannot be retained with the centering chuck.



Retention range	OD: ø0.1 - ø1.5mm
Dimensions	ø118x48.5mm
Mass	0.6kg

## Auto-leveling table: 178-087

This is a stage that performs fully automatic leveling as measurement starts, freeing the user from this troublesome operation. Fully automatic leveling can be done quickly by anyone. In addition, the operation is easy and reliable.



Inclination adjustment angle	±2°
Maximum load	7kg
Table dimensions	130x100mm
Mass	3.5kg



### 3-axis Adjustment Table: 178-047

This table helps make the alignment adjustments required when measuring cylindrical surfaces. The corrections for the pitch angle and the swivel angle are determined from a preliminary measurement and the Digimatic micrometers are adjusted accordingly. A flat-surfaced workpiece can also be leveled with this table.

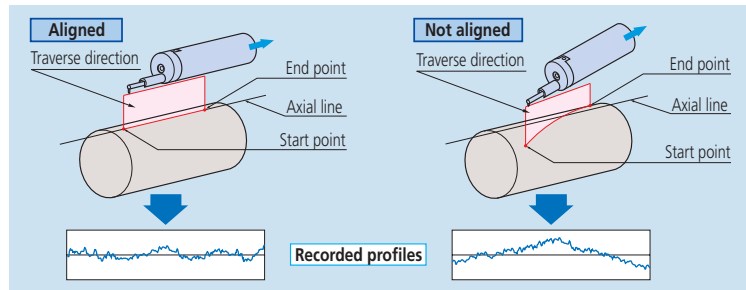

### Others

<b>Leveling table</b> 178-043-1(mm), 178-053-1(inch)	<b>Digital Leveling table</b> 178-042-1(mm), 178-052-1(inch)	<b>Leveling table</b> 178-016	<b>Leveling table (for D.A.T)</b> 178-058	<b>Calibration stand</b> 12AAG175
<b>V-block</b> 998291	<b>Precision vise</b> 178-019	<b>Cross-travel table</b> 218-001(mm), 218-011(inch)	<b>Cross-travel table</b> 218-041(mm), 218-051(inch)	
<b>Rotary vise</b> 218-003	<b>Center support</b> 172-142	<b>Center support riser</b> 172-143	<b>Swivel center support</b> 172-197	<b>Holder with clamp</b> 176-107
<b>V-block with clamp</b> 172-234, 172-378				

### Vibration isolator

Desktop type\*1  
No.178-023



Desk type\*1  
No.12AAK110

Desktop type\*1  
No.178-025



Monitor arm\*2  
No.12AAK120

Stand for Desktop type

External size WxDxH  
640x470x660mm  
Mass 25kg

No.178-024

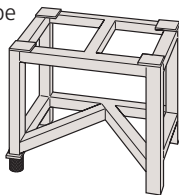

Side table\*2  
No.12AAL019



Example combination: with side table but no monitor arm (tester and PC not included)



Example combination: with monitor arm but no side table\*3 (tester and PC not included)

\*1: For models with a product code that ends in **S4, S8, H4, or H8**. Please contact us directly if you require units for models with a product code that ends in **W4 or W8** (large base models).

\*2: Used together with vibration isolator (No.12AAK110).

\*3: Please provide your own printer rack.

# Detectors / Styli

## Detectors

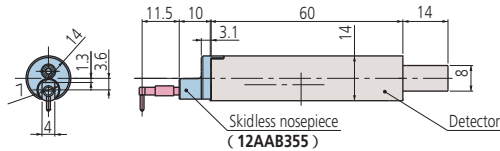

Order No.	Measuring force	
178-396-2	0.75mN	'97ISO and '01JIS compliant detectors
178-397-2	4mN	Detectors that comply with previous standards, for general use, etc.

## Extension rods

- 12AAG202 Extension rod 50mm



- 12AAG203 Extension rod 100mm



\* No more than one extension rod can be connected.

## Styli

### Standard stylus

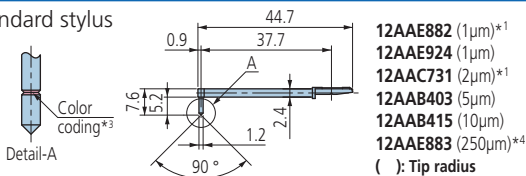

- 12AAE882 (1μm)\*1
- 12AAE924 (1μm)
- 12AAC731 (2μm)\*1
- 12AAB403 (5μm)
- 12AAB415 (10μm)
- 12AAE883 (250μm)\*4
- ( ) : Tip radius

### Double-length for deep hole \*2

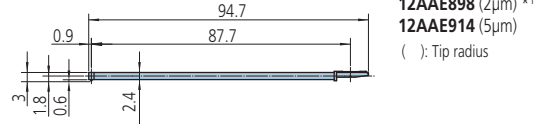

- 12AAE898 (2μm)\*1
- 12AAE914 (5μm)
- ( ) : Tip radius

### For small hole

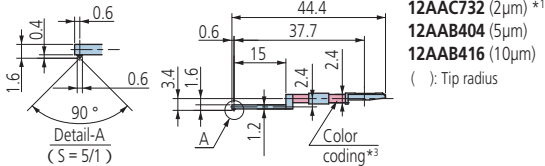

- 12AAC732 (2μm)\*1
- 12AAB404 (5μm)
- 12AAB416 (10μm)
- ( ) : Tip radius

### For small hole/Double-length for deep hole \*2

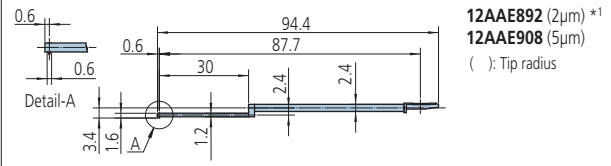

- 12AAE892 (2μm)\*1
- 12AAE908 (5μm)
- ( ) : Tip radius

### For extra-small hole

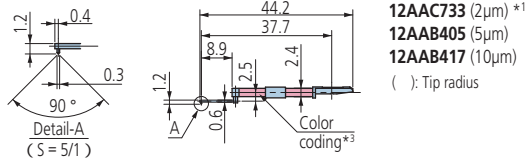

- 12AAC733 (2μm)\*1
- 12AAB405 (5μm)
- 12AAB417 (10μm)
- ( ) : Tip radius

### For small hole \*2 \*4

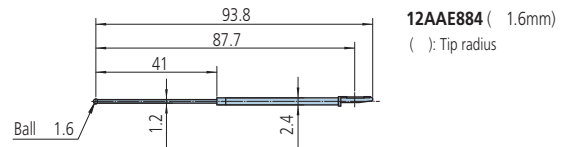

- 12AAE884 ( 1.6mm)
- ( ) : Tip radius

### For extra-minute hole

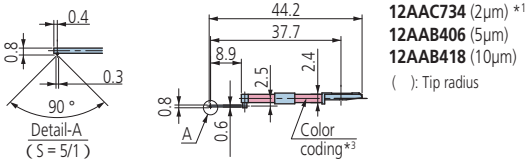

- 12AAC734 (2μm)\*1
- 12AAB406 (5μm)
- 12AAB418 (10μm)
- ( ) : Tip radius

### For ultra-small hole \*4

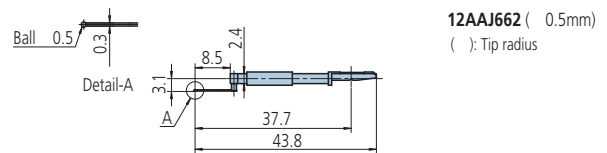

- 12AAJ662 ( 0.5mm)
- ( ) : Tip radius

### For deep hole (double-length and triple-length) \*2

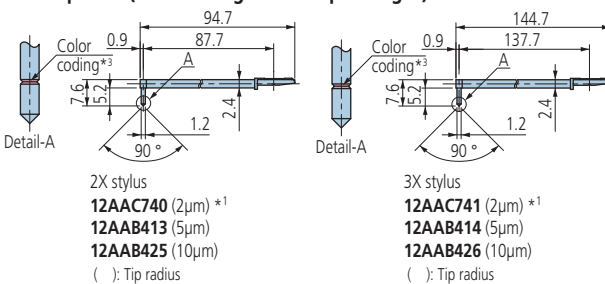

- 2X stylus
- 12AAC740 (2μm)\*1
  - 12AAB413 (5μm)
  - 12AAB425 (10μm)
  - ( ) : Tip radius

- 3X stylus
- 12AAC741 (2μm)\*1
  - 12AAB414 (5μm)
  - 12AAB426 (10μm)
  - ( ) : Tip radius

### For small slotted hole \*2

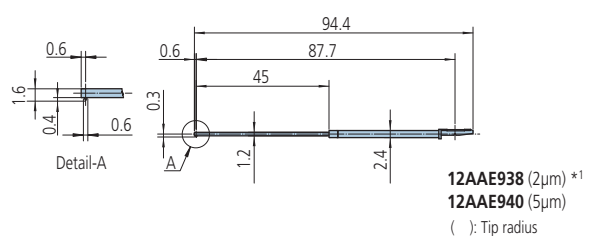

- 12AAE938 (2μm)\*1
- 12AAE940 (5μm)
- ( ) : Tip radius

\*1 : Tip angle 60°

\*2 : For downward-facing measurement only.

\*3 :

Tip radius	1μm	2μm	5μm	10μm	250μm
Color coding	White	Black	No color	Yellow	No notch or color

\*4 : Used for calibration, a standard step gauge (No.178-611, option) is also required



## Styli

### For deep groove (10mm)

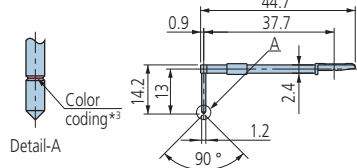

**12AAC735** (2μm)\*1  
**12AAB409** (5μm)  
**12AAB421** (10μm)  
 ( ) : Tip radius

### For deep groove \*2 (20mm)

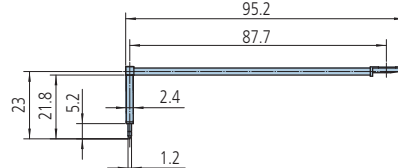

**12AAE893** (2μm) \*1  
**12AAE909** (5μm)  
 ( ) : Tip radius

### For deep groove \*2 (20mm)

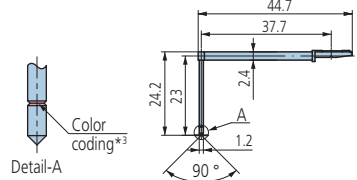

**12AAC736** (2μm)\*1  
**12AAB408** (5μm)  
**12AAB420** (10μm)  
 ( ) : Tip radius

### For deep groove \*2 (40mm)

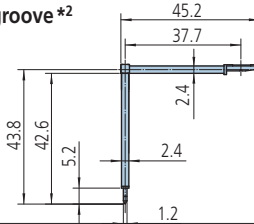

**12AAE895** (2μm) \*1  
**12AAE911** (5μm)  
 ( ) : Tip radius

### For deep groove \*2 (30mm)

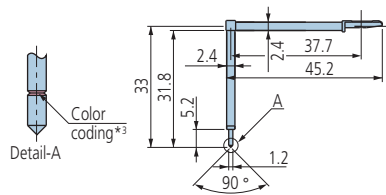

**12AAC737** (2μm) \*1  
**12AAB407** (5μm)  
**12AAB419** (10μm)  
 ( ) : Tip radius

### For deep groove (30mm)/Double-length for deep hole \*2

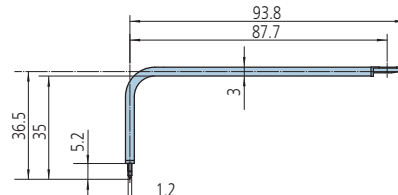

**12AAE894** (2μm) \*1  
**12AAE910** (5μm)  
 ( ) : Tip radius

### For gear tooth

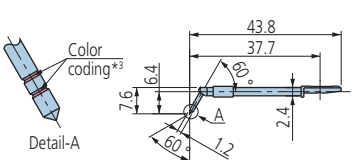

**12AAB339** (2μm)\*1  
**12AAB410** (5μm)  
**12AAB422** (10μm)  
 ( ) : Tip radius

### For gear tooth/Double-length for deep hole \*2

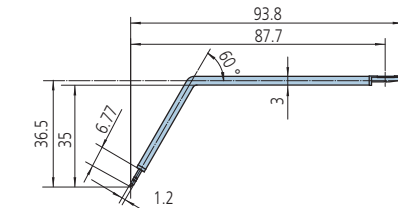

**12AAE896** (2μm) \*1  
**12AAE912** (5μm) \*1  
 ( ) : Tip radius

### For rolling circle waviness surface \*4

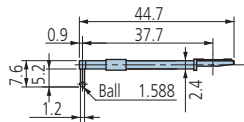

**12AAB338** ( 1.588)  
 ( ) : Tip radius

### For rolling circle waviness/Double-length for deep hole \*2 \*4

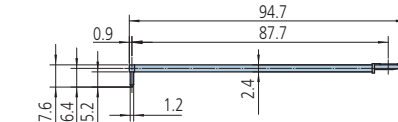

**12AAE886** (250μm)  
 ( ) : Tip radius

### For knife-edge

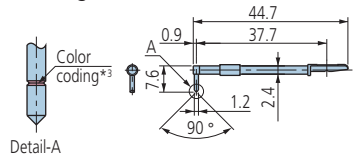

**12AAC738** (2μm) \*1  
**12AAB411** (5μm)  
**12AAB423** (10μm)  
 ( ) : Tip radius

### For corner hole/Double-length for deep hole \*2

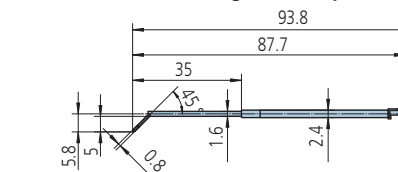

**12AAE897** (2μm) \*1  
**12AAE913** (5μm)\*2  
 ( ) : Tip radius

### For eccentric arm \*2

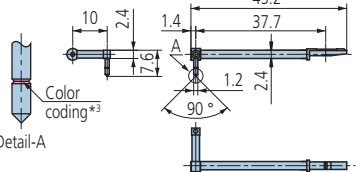

**12AAC739** (2μm) \*1  
**12AAB412** (5μm)  
**12AAB424** (10μm)  
 ( ) : Tip radius

### For bottom surface

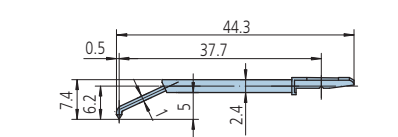

**12AAE899** (2μm) \*1  
**12AAE915** (5μm)  
 ( ) : Tip radius

\*1: Tip angle 60°

\*2: For downward-facing measurement only.

Customized special interchangeable styli are available on request, Please contact any Mitutoyo office for more information.

\*3:

Tip radius	2μm	5μm	10μm
Color coding	Black	No color	Yellow

\*4 : Used for calibration, a standard step gauge (No.178-611, option) is also required

# Specifications

Model No.		SV-3100S4	SV-3100H4	SV-3100W4	SV-3100S8	SV-3100H8	SV-3100W8	
Order No.	with 0.75mN detector	inch	178-461A-1*1	178-462A-1*1	178-463A-1*1	178-466A-1*1	178-467A-1*1	178-468A-1*1
			178-481A-1	178-482A-1	178-483A-1	178-486A-1	178-487A-1	178-488A-1
	with 4mN detector	inch	178-461A-2*1	178-462A-2*1	178-463A-2*1	178-466A-2*1	178-467A-2*1	178-468A-2*1
			178-481A-2	178-482A-2	178-483A-2	178-486A-2	178-487A-2	178-488A-2
Measuring range	X-axis	100mm (4")			200mm (8")			
	Z1-axis (detector unit)	800μm/80μm/8μm (32000μinch/3200μinch/320μinch)						
Detector	Detecting method		Differential inductance					
	Resolution		0.01μm (800μm range)/0.001μm (80μm range)/0.0001μm (8μm range) 0.4μinch (32000μinch)/0.04μinch (3200μinch)/0.4μinch (320μinch)					
	Stylus tip		According to the order No. (suffix 1: 60°/R2μm, suffix-2: 90°/R5μm)					
	Measuring force		According to the order No. (suffix 1: 0.75mN, suffix-2: 4mN)					
Drive unit : X-axis	Measuring speed		0.02 ~ 5mm/s (0.00078 ~ 0.2inch/s)					
	Drive speed		0 ~ 80mm/s (0 ~ 3.1inch/s) and manual operation					
	Straightness		(0.05+0.001L)μm [(2+1L)μinch]			0.5μm/200mm (20μinch/8inch)		
	Resolution		0.05μm (1.97μinch)					
Drive unit : Z2-axis	Traverse range 300mm		300mm (11.8")	500mm (19.7")	300mm (11.8")	500mm (19.7")		
	Drive speed		0 ~ 20mm/s (0 ~ 0.78inch/s) and manual operation					
	Resolution		1μm (39.4μinch)					
Conformable standards		JIS1982 / JIS1994 / JIS2001 / ISO1997 / ANSI / VDA						
Parameters		Ra, Rq, Sk, Ku, Rp, Rv, Ry, RyDIN, RzDIN, Rt, Rc, Rz, R3z, R3t, S, Δa, Δq, λa, λq, Lo, lr, Rk, Rpk, Rvk, Mr1, Mr2, A1, A2, Sm, Pc, HSC, mr, mrd, δc, Vo, Rx, AR, R, NR, NCRX, CPM, SR, SAR, Wx, AW, W, Wte, NW, SW, SAW						
Assessed profiles		Primary Profile, Roughness profile, Envelope residual curve, Filtered waviness curve, Band pass waviness curve, Waviness curve, Rolling circle waviness curve, Roughness motif, Waviness motif, DIN4776 curve						
Graphs		Amplitude distribution graphs, BAC1, BAC2, Power spectrum curve, Auto correlation curve Inclination angle distribution curve, Peak point height distribution curve, Parameter distribution curve						
Data compensation		Tilt compensation, R-surface compensation, Ellipse Compensation, Parabola compensation, Hyperbolic compensation, Polynomial compensation, Conic automatic compensation, Polynomial automatic compensation						
Filters		Gaussian filter, 2CRPC75, 2CRPC50, 2CR75, 2CR50, Robust spline filter						
Cutoff length		λc: 0.025, 0.08, 0.25, 0.8, 2.5, 8, 25, 80mm Arbitrary λs: 0.8, 2.5, 8, 25, 80, 250, 800μm Arbitrary						
Supported languages		Japanese, English, German, French, Italian, Spanish, Polish, Hungarian, Swedish, Czech, Simplified Chinese, Traditional Chinese, Korean, Turkish, Portuguese						
External dimensions (W×D×H)	Main unit		756×482 ×966mm	756×482 ×1166mm	1156×482 ×1176mm	766×482 ×966mm	766×482 ×1166mm	1166×482 ×1176mm
	Controller unit		221×344×490mm					
	Remote control box		248×102×62.2mm					
Mass	Main unit		140kg	150kg	220kg	140kg	150kg	220kg
	Controller unit		14 kg					
	Remote control box		0.9kg					
Power supply rating		100 ~ 120V, 200 ~ 240V ±10%, AC50/60Hz						

\*1: Models without X-axis inclination function

# Dimensions

## SV-3100S4/H4/W4

Unit: mm

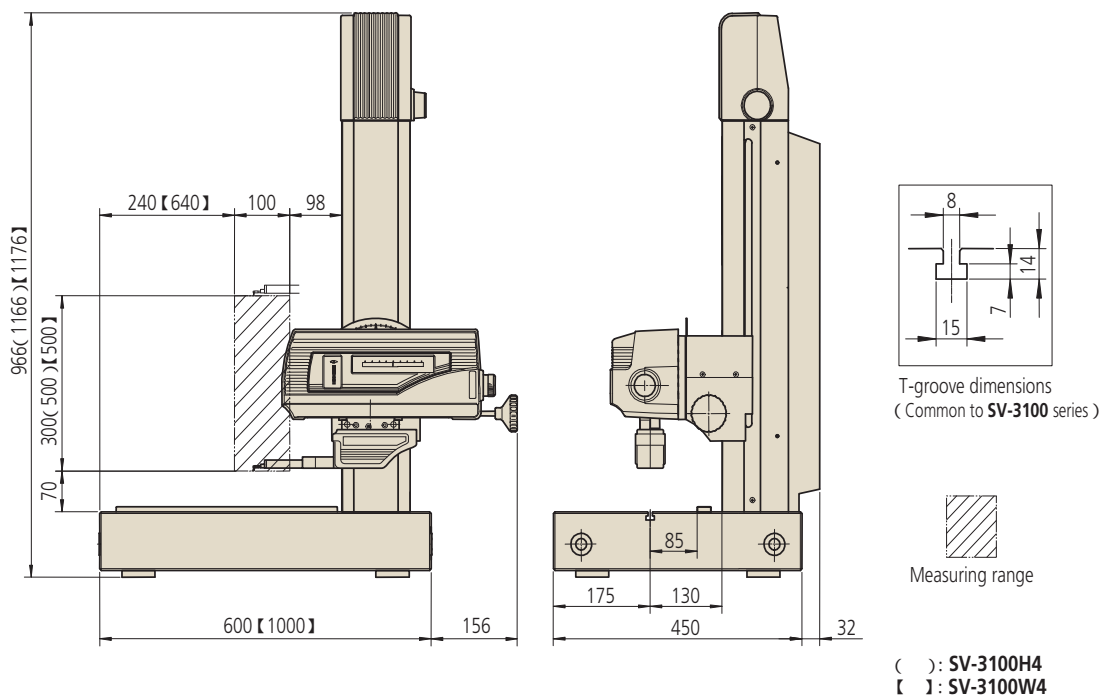

## SV-3100S8/H8/W8

Unit: mm

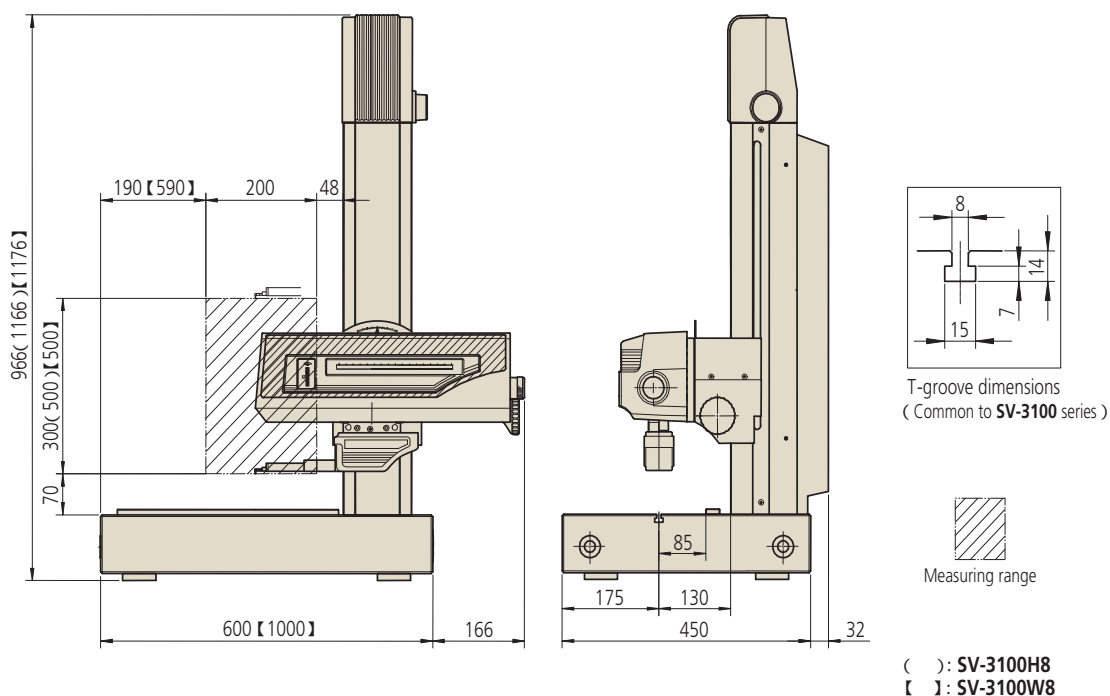



- Coordinate Measuring Machines
- Vision Measuring Systems
- Form Measurement
- Optical Measuring
- Sensor Systems
- Testing Equipment and Seismometer
- Digital Scale and DRO Systems
- Small Tool Instruments and Data Management

## Mitutoyo America Corporation

www.mitutoyo.com

One Number to Serve You Better  
**1-888-MITUTOYO (1-888-648-8869)**

### M<sup>3</sup> Solution Centers

- Aurora, Illinois**  
(Corporate Headquarters)
- Westford, Massachusetts**
- Huntersville, North Carolina**
- Mason, Ohio**
- Plymouth, Michigan**
- City of Industry, California**
- Birmingham, Alabama**

**Note:** All information regarding our products, and in particular the illustrations, drawings, dimensional and performance data contained in this printed matter as well as other technical data are to be regarded as approximate average values. We therefore reserve the right to make changes to the corresponding designs. The stated standards, similar technical regulations, descriptions and illustrations of the products were valid at the time of printing. In addition, the latest applicable version of our General Trading Conditions will apply. Only quotations submitted by ourselves may be regarded as definitive. Specifications are subject to change without notice.

Mitutoyo products are subject to US Export Administration Regulations (EAR). Re-export or relocation of our products may require prior approval by an appropriate governing authority.

#### Trademarks and Registrations

Designations used by companies to distinguish their products are often claimed as trademarks. In all instances where Mitutoyo America Corporation is aware of a claim, the product names appear in initial capital or all capital letters. The appropriate companies should be contacted for more complete trademark and registration information.